

# BD179

## Plastic Medium-Power NPN Silicon Transistor

This device is designed for use in 5.0 to 10 Watt audio amplifiers and drivers utilizing complementary or quasi complementary circuits.

### Features

- DC Current Gain -  $h_{FE} = 40$  (Min) @  $I_C = 0.15$  Adc
- BD179 is complementary with BD180
- Pb-Free Package is Available\*

### MAXIMUM RATINGS

Rating	Symbol	Value	Unit
Collector-Emitter Voltage	$V_{CEO}$	80	Vdc
Collector-Base Voltage	$V_{CBO}$	80	Vdc
Emitter-Base Voltage	$V_{EBO}$	5.0	Vdc
Collector Current	$I_C$	3.0	Adc
Base Current	$I_B$	1.0	Adc
Total Power Dissipation @ $T_C = 25^\circ\text{C}$ Derate above $25^\circ\text{C}$	$P_D$	30 240	W mW/ $^\circ\text{C}$
Operating and Storage Junction Temperature Range	$T_J, T_{stg}$	-65 to +150	$^\circ\text{C}$

### THERMAL CHARACTERISTICS

Characteristic	Symbol	Max	Unit
Thermal Resistance, Junction-to-Case	$\theta_{JC}$	4.16	$^\circ\text{C}/\text{W}$

Stresses exceeding Maximum Ratings may damage the device. Maximum Ratings are stress ratings only. Functional operation above the Recommended Operating Conditions is not implied. Extended exposure to stresses above the Recommended Operating Conditions may affect device reliability.



**ON Semiconductor®**

<http://onsemi.com>

**3.0 AMPERES  
POWER TRANSISTORS  
NPN SILICON  
80 VOLTS, 30 WATTS**

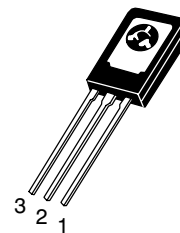

TO-225  
CASE 77  
STYLE 1

### MARKING DIAGRAM

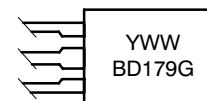

Y = Year  
WW = Work Week  
BD179 = Device Code  
G = Pb-Free Package

### ORDERING INFORMATION

Device	Package	Shipping
BD179	TO-225	500 Units/Box
BD179G	TO-225 (Pb-Free)	500 Units/Box

\*For additional information on our Pb-Free strategy and soldering details, please download the ON Semiconductor Soldering and Mounting Techniques Reference Manual, SOLDERRM/D.

**ELECTRICAL CHARACTERISTICS** ( $T_C = 25^\circ\text{C}$  unless otherwise noted)

Characteristic	Symbol	Min	Max	Unit
Collector-Emitter Sustaining Voltage (Note 1) ( $I_C = 0.1\text{ Adc}$ , $I_B = 0$ )	$V_{(BR)CEO}$	80	-	Vdc
Collector Cutoff Current ( $V_{CB} = 80\text{ Vdc}$ , $I_E = 0$ )	$I_{CBO}$	-	0.1	mAdc
Emitter Cutoff Current ( $V_{BE} = 5.0\text{ Vdc}$ , $I_C = 0$ )	$I_{EBO}$	-	1.0	mAdc
DC Current Gain ( $I_C = 0.15\text{ A}$ , $V_{CE} = 2.0\text{ V}$ ) ( $I_C = 1.0\text{ A}$ , $V_{CE} = 2.0\text{ V}$ )	$h_{FE}$	63 15	160 -	-
Collector-Emitter Saturation Voltage (Note 1) ( $I_C = 1.0\text{ Adc}$ , $I_B = 0.1\text{ Adc}$ )	$V_{CE(sat)}$	-	0.8	Vdc
Base-Emitter On Voltage (Note 1) ( $I_C = 1.0\text{ Adc}$ , $V_{CE} = 2.0\text{ Vdc}$ )	$V_{BE(on)}$	-	1.3	Vdc
Current-Gain - Bandwidth Product ( $I_C = 250\text{ mAdc}$ , $V_{CE} = 10\text{ Vdc}$ , $f = 1.0\text{ MHz}$ )	$f_T$	3.0	-	MHz

1. Pulse Test: Pulse Width  $\leq 300\text{ As}$ , Duty Cycle  $\leq 2.0\%$ .

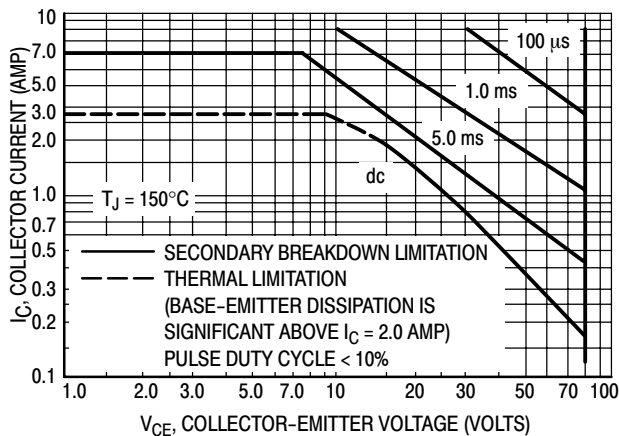

Figure 1. Active Region Safe Operating Area

The Safe Operating Area Curves indicate  $I_C - V_{CE}$  limits below which the device will not enter secondary breakdown. Collector load lines for specific circuits must fall within the applicable Safe Area to avoid causing a catastrophic failure. To insure operation below the maximum  $T_J$ , power-temperature derating must be observed for both steady state and pulse power conditions.

# BD179

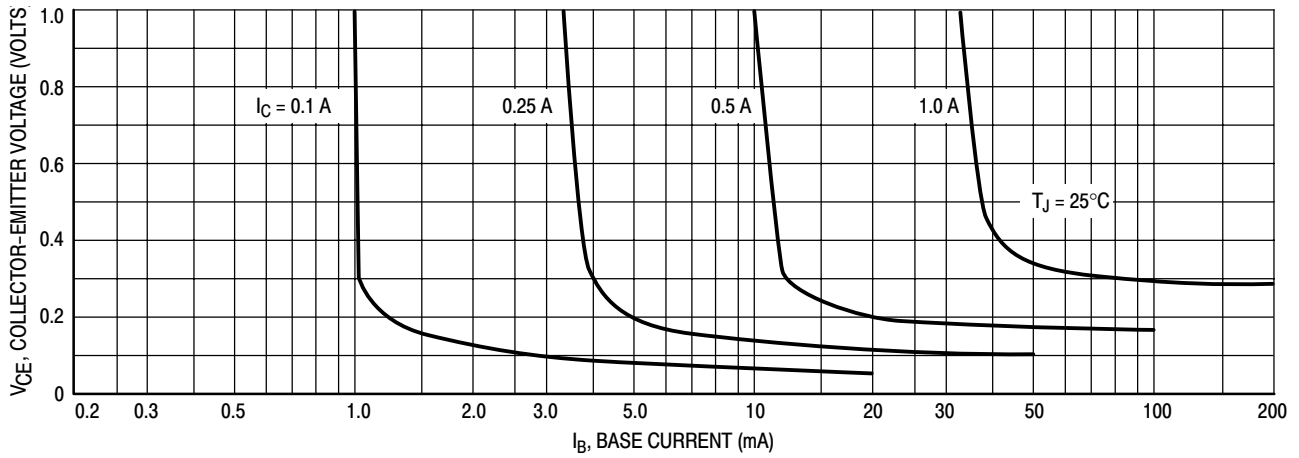

Figure 2. Collector Saturation Region

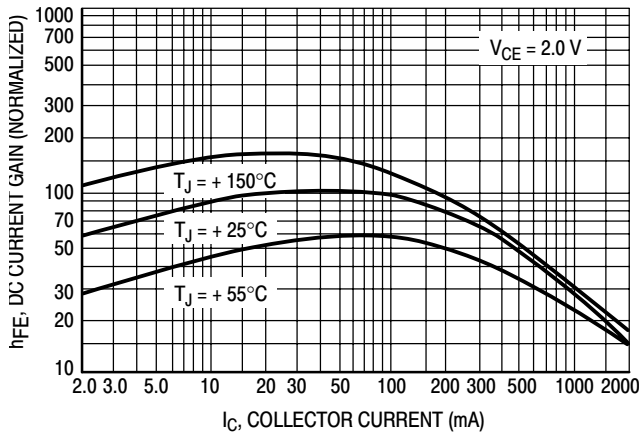

Figure 3. Current Gain

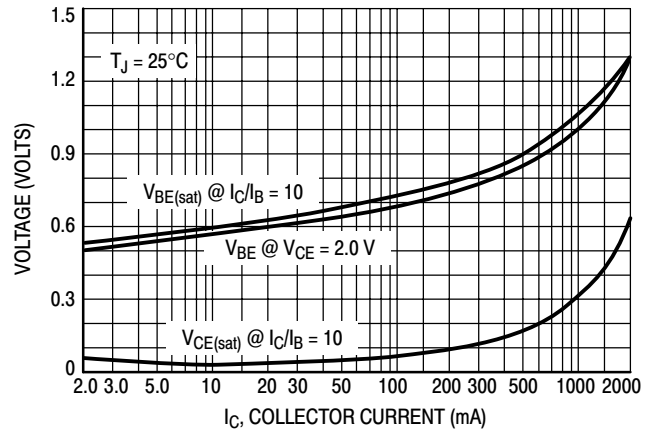

Figure 4. "On" Voltages

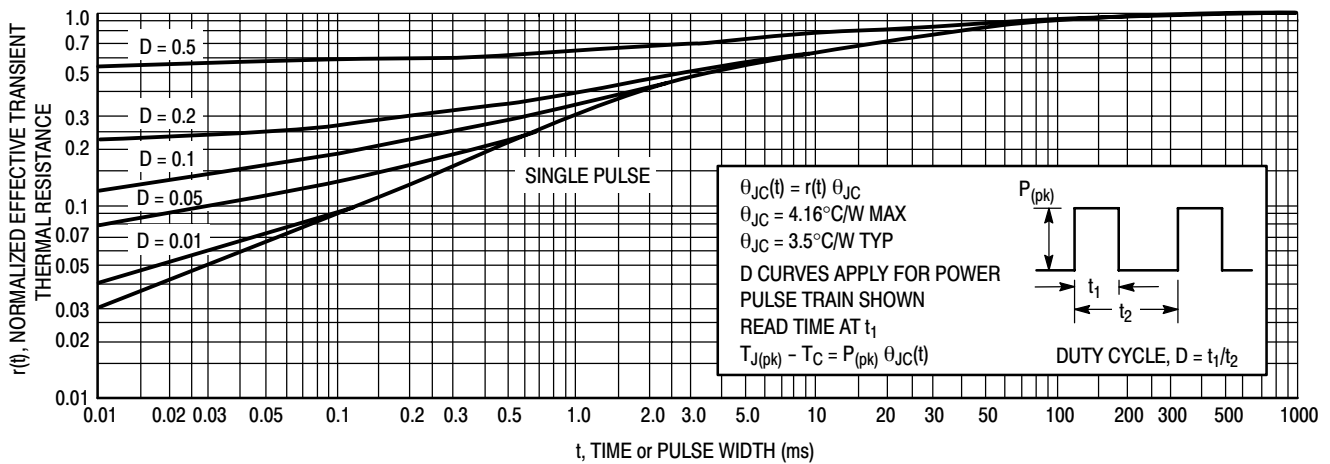
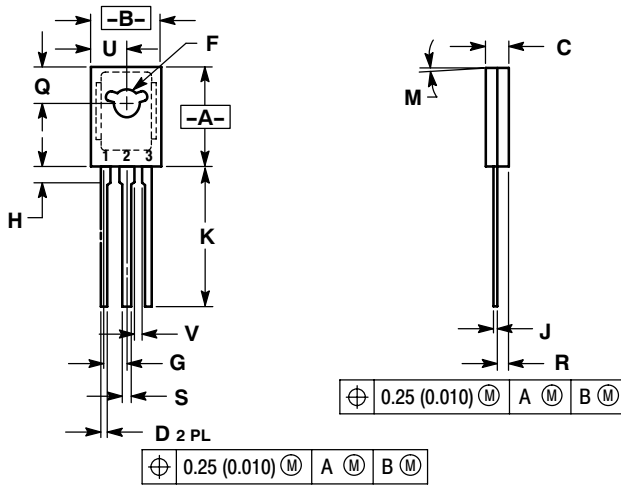

Figure 5. Thermal Response

# BD179

## PACKAGE DIMENSIONS

TO-225  
CASE 77-09  
ISSUE Z



### NOTES:

1. DIMENSIONING AND TOLERANCING PER ANSI Y14.5M, 1982.
2. CONTROLLING DIMENSION: INCH.
3. 077-01 THRU -08 OBSOLETE, NEW STANDARD 077-09.

DIM	INCHES		MILLIMETERS	
	MIN	MAX	MIN	MAX
A	0.425	0.435	10.80	11.04
B	0.295	0.305	7.50	7.74
C	0.095	0.105	2.42	2.66
D	0.020	0.026	0.51	0.66
F	0.115	0.130	2.93	3.30
G	0.094 BSC		2.39 BSC	
H	0.050	0.095	1.27	2.41
J	0.015	0.025	0.39	0.63
K	0.575	0.655	14.61	16.63
M	5° TYP		5° TYP	
Q	0.148	0.158	3.76	4.01
R	0.045	0.065	1.15	1.65
S	0.025	0.035	0.64	0.88
U	0.145	0.155	3.69	3.93
V	0.040	---	1.02	---

### STYLE 1:

- PIN 1. EMITTER
- COLLECTOR
- BASE

ON Semiconductor and are registered trademarks of Semiconductor Components Industries, LLC (SCILLC). SCILLC reserves the right to make changes without further notice to any products herein. SCILLC makes no warranty, representation or guarantee regarding the suitability of its products for any particular purpose, nor does SCILLC assume any liability arising out of the application or use of any product or circuit, and specifically disclaims any and all liability, including without limitation special, consequential or incidental damages. "Typical" parameters which may be provided in SCILLC data sheets and/or specifications can and do vary in different applications and actual performance may vary over time. All operating parameters, including "Typicals" must be validated for each customer application by customer's technical experts. SCILLC does not convey any license under its patent rights nor the rights of others. SCILLC products are not designed, intended, or authorized for use as components in systems intended for surgical implant into the body, or other applications intended to support or sustain life, or for any other application in which the failure of the SCILLC product could create a situation where personal injury or death may occur. Should Buyer purchase or use SCILLC products for any such unintended or unauthorized application, Buyer shall indemnify and hold SCILLC and its officers, employees, subsidiaries, affiliates, and distributors harmless against all claims, costs, damages, and expenses, and reasonable attorney fees arising out of, directly or indirectly, any claim of personal injury or death associated with such unintended or unauthorized use, even if such claim alleges that SCILLC was negligent regarding the design or manufacture of the part. SCILLC is an Equal Opportunity/Affirmative Action Employer. This literature is subject to all applicable copyright laws and is not for resale in any manner.

### PUBLICATION ORDERING INFORMATION

#### LITERATURE FULFILLMENT:

Literature Distribution Center for ON Semiconductor  
P.O. Box 5163, Denver, Colorado 80217 USA  
Phone: 303-675-2175 or 800-344-3860 Toll Free USA/Canada  
Fax: 303-675-2176 or 800-344-3867 Toll Free USA/Canada  
Email: [orderlit@onsemi.com](mailto:orderlit@onsemi.com)

N. American Technical Support: 800-282-9855 Toll Free  
USA/Canada  
Europe, Middle East and Africa Technical Support:  
Phone: 421 33 790 2910  
Japan Customer Focus Center  
Phone: 81-3-5773-3850

ON Semiconductor Website: [www.onsemi.com](http://www.onsemi.com)

Order Literature: <http://www.onsemi.com/orderlit>

For additional information, please contact your local Sales Representative

BD179/D