

# PZT222AT1

## NPN Silicon Planar Epitaxial Transistor

This NPN Silicon Epitaxial transistor is designed for use in linear and switching applications. The device is housed in the SOT-223 package which is designed for medium power surface mount applications.

### Features

- PNP Complement is PZT2907AT1
- The SOT-223 Package Can be Soldered Using Wave or Reflow
- SOT-223 Package Ensures Level Mounting, Resulting in Improved Thermal Conduction, and Allows Visual Inspection of Soldered Joints
- The Formed Leads Absorb Thermal Stress During Soldering, Eliminating the Possibility of Damage to the Die
- Available in 12 mm Tape and Reel
- These Devices are Pb-Free, Halogen Free/BFR Free and are RoHS Compliant

### MAXIMUM RATINGS

Rating	Symbol	Value	Unit
Collector-Emitter Voltage	$V_{CEO}$	40	Vdc
Collector-Base Voltage	$V_{CBO}$	75	Vdc
Emitter-Base Voltage (Open Collector)	$V_{EBO}$	6.0	Vdc
Collector Current	$I_C$	600	mAdc
Total Power Dissipation up to $T_A = 25^\circ\text{C}$ (Note 1)	$P_D$	1.5	W
Storage Temperature Range	$T_{stg}$	- 65 to +150	$^\circ\text{C}$
Junction Temperature	$T_J$	150	$^\circ\text{C}$

Stresses exceeding Maximum Ratings may damage the device. Maximum Ratings are stress ratings only. Functional operation above the Recommended Operating Conditions is not implied. Extended exposure to stresses above the Recommended Operating Conditions may affect device reliability.

1. Device mounted on an epoxy printed circuit board 1.575 inches x 1.575 inches x 0.059 inches; mounting pad for the collector lead min. 0.93 inches<sup>2</sup>.

### THERMAL CHARACTERISTICS

Rating	Symbol	Value	Unit
Thermal Resistance, Junction-to-Ambient	$R_{\theta JA}$	83.3	$^\circ\text{C}/\text{W}$
Lead Temperature for Soldering, 0.0625" from case Time in Solder Bath	$T_L$	260 10	$^\circ\text{C}$ Sec



ON Semiconductor®

<http://onsemi.com>

### SOT-223 PACKAGE NPN SILICON TRANSISTOR SURFACE MOUNT

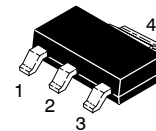
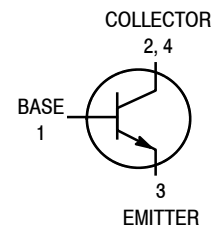

SOT-223 (TO-261)  
CASE 318E-04  
STYLE 1

### MARKING DIAGRAM

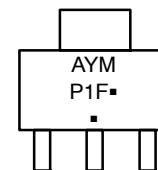

A = Assembly Location  
Y = Year  
M = Month Code  
▪ = Pb-Free Package

(Note: Microdot may be in either location)

### ORDERING INFORMATION

Device	Package	Shipping†
PZT222AT1G	SOT-223 (Pb-Free)	1000 Tape & Reel
PZT222AT3G	SOT-223 (Pb-Free)	4000 Tape & Reel

†For information on tape and reel specifications, including part orientation and tape sizes, please refer to our Tape and Reel Packaging Specifications Brochure, BRD8011/D.

# PZT2222AT1

## ELECTRICAL CHARACTERISTICS (T<sub>A</sub> = 25°C unless otherwise noted)

Characteristic	Symbol	Min	Max	Unit
<b>OFF CHARACTERISTICS</b>				
Collector-Emitter Breakdown Voltage (I <sub>C</sub> = 10 mAdc, I <sub>B</sub> = 0)	V <sub>(BR)CEO</sub>	40	-	Vdc
Collector-Base Breakdown Voltage (I <sub>C</sub> = 10 μAdc, I <sub>E</sub> = 0)	V <sub>(BR)CBO</sub>	75	-	Vdc
Emitter-Base Breakdown Voltage (I <sub>E</sub> = 10 μAdc, I <sub>C</sub> = 0)	V <sub>(BR)EBO</sub>	6.0	-	Vdc
Base-Emitter Cutoff Current (V <sub>CE</sub> = 60 Vdc, V <sub>BE</sub> = - 3.0 Vdc)	I <sub>BEX</sub>	-	20	nAdc
Collector-Emitter Cutoff Current (V <sub>CE</sub> = 60 Vdc, V <sub>BE</sub> = - 3.0 Vdc)	I <sub>CEX</sub>	-	10	nAdc
Emitter-Base Cutoff Current (V <sub>EB</sub> = 3.0 Vdc, I <sub>C</sub> = 0)	I <sub>EBO</sub>	-	100	nAdc
Collector-Base Cutoff Current (V <sub>CB</sub> = 60 Vdc, I <sub>E</sub> = 0) (V <sub>CB</sub> = 60 Vdc, I <sub>E</sub> = 0, T <sub>A</sub> = 125°C)	I <sub>CBO</sub>	-	10	nAdc μAdc

## ON CHARACTERISTICS

DC Current Gain (I <sub>C</sub> = 0.1 mAdc, V <sub>CE</sub> = 10 Vdc) (I <sub>C</sub> = 1.0 mAdc, V <sub>CE</sub> = 10 Vdc) (I <sub>C</sub> = 10 mAdc, V <sub>CE</sub> = 10 Vdc) (I <sub>C</sub> = 10 mAdc, V <sub>CE</sub> = 10 Vdc, T <sub>A</sub> = - 55°C) (I <sub>C</sub> = 150 mAdc, V <sub>CE</sub> = 10 Vdc) (I <sub>C</sub> = 150 mAdc, V <sub>CE</sub> = 1.0 Vdc) (I <sub>C</sub> = 500 mAdc, V <sub>CE</sub> = 10 Vdc)	h <sub>FE</sub>	35 50 70 35 100 50 40	- - - - 300 - -	-
Collector-Emitter Saturation Voltages (I <sub>C</sub> = 150 mAdc, I <sub>B</sub> = 15 mAdc) (I <sub>C</sub> = 500 mAdc, I <sub>B</sub> = 50 mAdc)	V <sub>CE(sat)</sub>	- -	0.3 1.0	Vdc
Base-Emitter Saturation Voltages (I <sub>C</sub> = 150 mAdc, I <sub>B</sub> = 15 mAdc) (I <sub>C</sub> = 500 mAdc, I <sub>B</sub> = 50 mAdc)	V <sub>BE(sat)</sub>	0.6 -	1.2 2.0	Vdc
Input Impedance (V <sub>CE</sub> = 10 Vdc, I <sub>C</sub> = 1.0 mAdc, f = 1.0 kHz) (V <sub>CE</sub> = 10 Vdc, I <sub>C</sub> = 10 mAdc, f = 1.0 kHz)	h <sub>ie</sub>	2.0 0.25	8.0 1.25	kΩ
Voltage Feedback Ratio (V <sub>CE</sub> = 10 Vdc, I <sub>C</sub> = 1.0 mAdc, f = 1.0 kHz) (V <sub>CE</sub> = 10 Vdc, I <sub>C</sub> = 10 mAdc, f = 1.0 kHz)	h <sub>re</sub>	- -	8.0x10 <sup>-4</sup> 4.0x10 <sup>-4</sup>	-
Small-Signal Current Gain (V <sub>CE</sub> = 10 Vdc, I <sub>C</sub> = 1.0 mAdc, f = 1.0 kHz) (V <sub>CE</sub> = 10 Vdc, I <sub>C</sub> = 10 mAdc, f = 1.0 kHz)	h <sub>fe</sub>	50 75	300 375	-
Output Admittance (V <sub>CE</sub> = 10 Vdc, I <sub>C</sub> = 1.0 mAdc, f = 1.0 kHz) (V <sub>CE</sub> = 10 Vdc, I <sub>C</sub> = 10 mAdc, f = 1.0 kHz)	h <sub>oe</sub>	5.0 25	35 200	μmhos
Noise Figure (V <sub>CE</sub> = 10 Vdc, I <sub>C</sub> = 100 μAdc, f = 1.0 kHz)	F	-	4.0	dB

## DYNAMIC CHARACTERISTICS

Current-Gain - Bandwidth Product (I <sub>C</sub> = 20 mAdc, V <sub>CE</sub> = 20 Vdc, f = 100 MHz)	f <sub>T</sub>	300	-	MHz
Output Capacitance (V <sub>CB</sub> = 10 Vdc, I <sub>E</sub> = 0, f = 1.0 MHz)	C <sub>c</sub>	-	8.0	pF
Input Capacitance (V <sub>EB</sub> = 0.5 Vdc, I <sub>C</sub> = 0, f = 1.0 MHz)	C <sub>e</sub>	-	25	pF

## SWITCHING TIMES (T<sub>A</sub> = 25°C)

Delay Time	(V <sub>CC</sub> = 30 Vdc, I <sub>C</sub> = 150 mAdc, I <sub>B(on)</sub> = 15 mAdc, V <sub>EB(off)</sub> = 0.5 Vdc) Figure 1	t <sub>d</sub>	-	10	ns
Rise Time		t <sub>r</sub>	-	25	
Storage Time	(V <sub>CC</sub> = 30 Vdc, I <sub>C</sub> = 150 mAdc, I <sub>B(on)</sub> = I <sub>B(off)</sub> = 15 mAdc) Figure 2	t <sub>s</sub>	-	225	ns
Fall Time		t <sub>f</sub>	-	60	

# PZT2222AT1

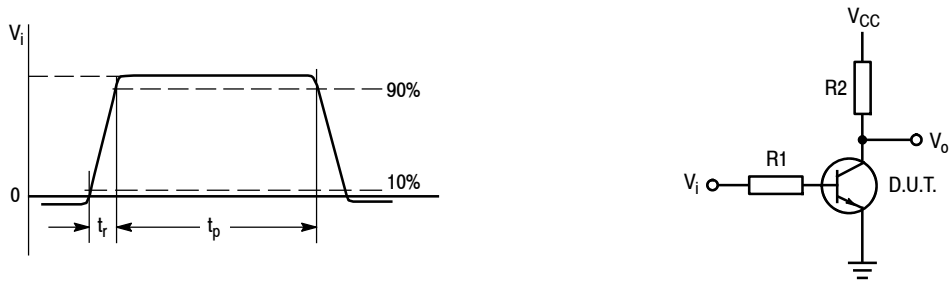

**Figure 1. Input Waveform and Test Circuit for Determining Delay Time and Rise Time**

$V_i = -0.5 \text{ V to } +9.9 \text{ V}$ ,  $V_{CC} = +30 \text{ V}$ ,  $R_1 = 619 \Omega$ ,  $R_2 = 200 \Omega$ .

**PULSE GENERATOR:**

**PULSE DURATION**  $t_p$  3 200 ns  
**RISE TIME**  $t_r$  3 2 ns  
**DUTY FACTOR**  $\delta$  = 0.02

**OSCILLOSCOPE:**

**INPUT IMPEDANCE**  $Z_i > 100 \text{ k}\Omega$   
**INPUT CAPACITANCE**  $C_i < 12 \text{ pF}$   
**RISE TIME**  $t_r < 5 \text{ ns}$

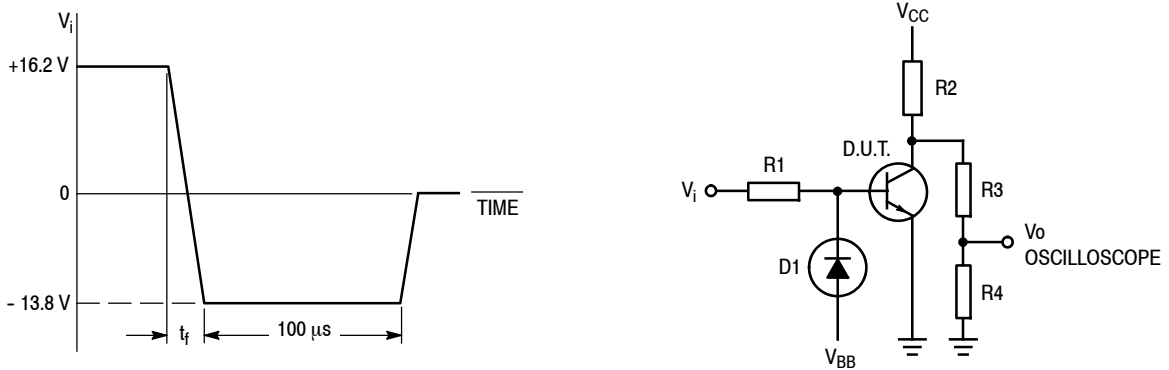
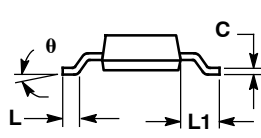
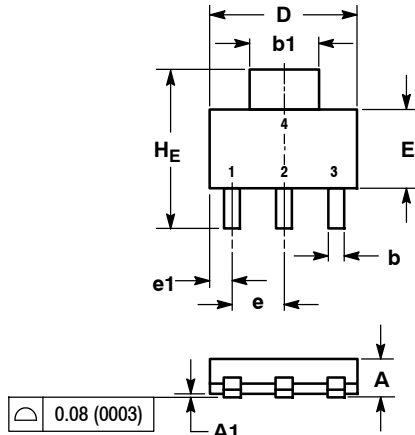

**Figure 2. Input Waveform and Test Circuit for Determining Storage Time and Fall Time**

# PZT2222AT1

## PACKAGE DIMENSIONS

SOT-223 (TO-261)  
CASE 318E-04  
ISSUE N



NOTES:  
1. DIMENSIONING AND TOLERANCING PER ASME Y14.5M, 1994.  
2. CONTROLLING DIMENSION: INCH

DIM	MILLIMETERS			INCHES		
	MIN	NOM	MAX	MIN	NOM	MAX
A	1.50	1.63	1.75	0.060	0.064	0.068
A1	0.02	0.06	0.10	0.001	0.002	0.004
b	0.60	0.75	0.89	0.024	0.030	0.035
b1	2.90	3.06	3.20	0.115	0.121	0.126
c	0.24	0.29	0.35	0.009	0.012	0.014
D	6.30	6.50	6.70	0.249	0.256	0.263
E	3.30	3.50	3.70	0.130	0.138	0.145
e	2.20	2.30	2.40	0.087	0.091	0.094
e1	0.85	0.94	1.05	0.033	0.037	0.041
L	0.20	---	---	0.008	---	---
L1	1.50	1.75	2.00	0.060	0.069	0.078
HE	6.70	7.00	7.30	0.264	0.276	0.287
θ	0°	-	10°	0°	-	10°

STYLE 1:  
PIN 1. BASE  
2. COLLECTOR  
3. EMITTER  
4. COLLECTOR

### SOLDERING FOOTPRINT\*

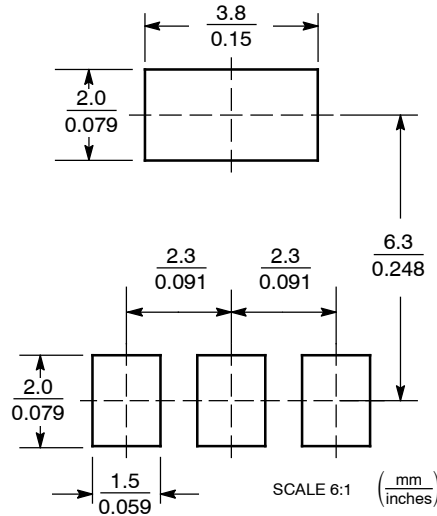

\*For additional information on our Pb-Free strategy and soldering details, please download the ON Semiconductor Soldering and Mounting Techniques Reference Manual, SOLDERRM/D.

ON Semiconductor and are registered trademarks of Semiconductor Components Industries, LLC (SCILLC). SCILLC reserves the right to make changes without further notice to any products herein. SCILLC makes no warranty, representation or guarantee regarding the suitability of its products for any particular purpose, nor does SCILLC assume any liability arising out of the application or use of any product or circuit, and specifically disclaims any and all liability, including without limitation special, consequential or incidental damages. "Typical" parameters which may be provided in SCILLC data sheets and/or specifications can and do vary in different applications and actual performance may vary over time. All operating parameters, including "Typicals" must be validated for each customer application by customer's technical experts. SCILLC does not convey any license under its patent rights nor the rights of others. SCILLC products are not designed, intended, or authorized for use as components in systems intended for surgical implant into the body, or other applications intended to support or sustain life, or for any other application in which the failure of the SCILLC product could create a situation where personal injury or death may occur. Should Buyer purchase or use SCILLC products for any such unintended or unauthorized application, Buyer shall indemnify and hold SCILLC and its officers, employees, subsidiaries, affiliates, and distributors harmless against all claims, costs, damages, and expenses, and reasonable attorney fees arising out of, directly or indirectly, any claim of personal injury or death associated with such unintended or unauthorized use, even if such claim alleges that SCILLC was negligent regarding the design or manufacture of the part. SCILLC is an Equal Opportunity/Affirmative Action Employer. This literature is subject to all applicable copyright laws and is not for resale in any manner.

### PUBLICATION ORDERING INFORMATION

LITERATURE FULFILLMENT:  
Literature Distribution Center for ON Semiconductor  
P.O. Box 5163, Denver, Colorado 80217 USA  
Phone: 303-675-2175 or 800-344-3860 Toll Free USA/Canada  
Fax: 303-675-2176 or 800-344-3867 Toll Free USA/Canada  
Email: orderlit@onsemi.com

N. American Technical Support: 800-282-9855 Toll Free  
USA/Canada  
Europe, Middle East and Africa Technical Support:  
Phone: 421 33 790 2910  
Japan Customer Focus Center  
Phone: 81-3-5773-3850

ON Semiconductor Website: [www.onsemi.com](http://www.onsemi.com)  
Order Literature: <http://www.onsemi.com/orderlit>  
For additional information, please contact your local Sales Representative

PZT2222AT1/D