

# MSD42WT1G, MSD42T1G

## NPN Silicon General Purpose High Voltage Transistors

This NPN Silicon Planar Transistor is designed for general purpose amplifier applications. This device is housed in the SC-70/SOT-323 and SC-59 packages which are designed for low power surface mount applications.

### Features

- These Devices are Pb-Free, Halogen Free/BFR Free and are RoHS Compliant

### MAXIMUM RATINGS ( $T_A = 25^\circ\text{C}$ )

Rating	Symbol	Value	Unit
Collector-Base Voltage	$V_{(BR)CBO}$	300	Vdc
Collector-Emitter Voltage	$V_{(BR)CEO}$	300	Vdc
Emitter-Base Voltage	$V_{(BR)EBO}$	6.0	Vdc
Collector Current – Continuous	$I_C$	150	mAdc

### THERMAL CHARACTERISTICS

Rating	Symbol	Max	Unit
Power Dissipation (Note 1)	$P_D$	150	mW
Junction Temperature	$T_J$	150	$^\circ\text{C}$
Storage Temperature Range	$T_{stg}$	-55 ~ +150	$^\circ\text{C}$

Stresses exceeding Maximum Ratings may damage the device. Maximum Ratings are stress ratings only. Functional operation above the Recommended Operating Conditions is not implied. Extended exposure to stresses above the Recommended Operating Conditions may affect device reliability.

### ELECTRICAL CHARACTERISTICS

Characteristic	Symbol	Min	Max	Unit
Collector-Emitter Breakdown Voltage ( $I_C = 1.0 \text{ mAdc}$ , $I_B = 0$ )	$V_{(BR)CEO}$	300	-	Vdc
Collector-Base Breakdown Voltage ( $I_C = 100 \mu\text{Adc}$ , $I_E = 0$ )	$V_{(BR)CBO}$	300	-	Vdc
Emitter-Base Breakdown Voltage ( $I_E = 100 \mu\text{Adc}$ , $I_C = 0$ )	$V_{(BR)EBO}$	6.0	-	Vdc
Collector-Base Cutoff Current ( $V_{CB} = 200 \text{ Vdc}$ , $I_E = 0$ )	$I_{CBO}$	-	0.1	$\mu\text{A}$
Emitter-Base Cutoff Current ( $V_{EB} = 6.0 \text{ Vdc}$ , $I_B = 0$ )	$I_{EBO}$	-	0.1	$\mu\text{A}$
DC Current Gain (Note 2) ( $V_{CE} = 10 \text{ Vdc}$ , $I_C = 1.0 \text{ mAdc}$ ) ( $V_{CE} = 10 \text{ Vdc}$ , $I_C = 30 \text{ mAdc}$ )	$h_{FE1}$ $h_{FE2}$	25 40	- -	-
Collector-Emitter Saturation Voltage (Note 2) ( $I_C = 20 \text{ mAdc}$ , $I_B = 2.0 \text{ mAdc}$ )	$V_{CE(sat)}$	-	0.5	Vdc

1. Device mounted on a FR-4 glass epoxy printed circuit board using the minimum recommended footprint.
2. Pulse Test: Pulse Width  $\leq 300 \mu\text{s}$ , D.C.  $\leq 2\%$ .



ON Semiconductor®

<http://onsemi.com>

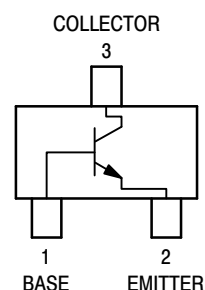

SC-70 (SOT-323)  
CASE 419  
STYLE 3



SC-59  
CASE 318D

### MARKING DIAGRAMS

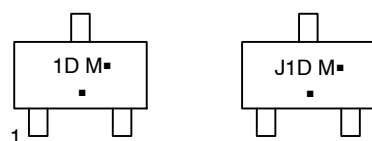

XXX = Specific Device Code  
M = Date Code  
▪ = Pb-Free Package  
(Note: Microdot may be in either location)

### ORDERING INFORMATION

Device	Package	Shipping†
MSD42WT1G	SC-70 (Pb-Free)	3000 / Tape & Reel
MSD42T1G	SC-59 (Pb-Free)	3000 / Tape & Reel

†For information on tape and reel specifications, including part orientation and tape sizes, please refer to our Tape and Reel Packaging Specifications Brochure, BRD8011/D.

# MSD42WT1G, MSD42T1G

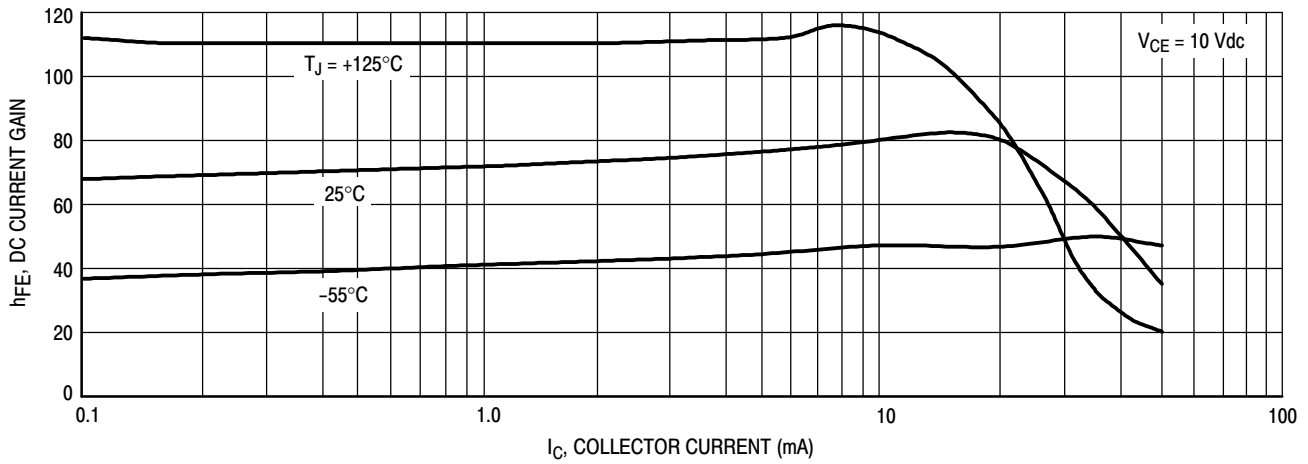

Figure 1. DC Current Gain

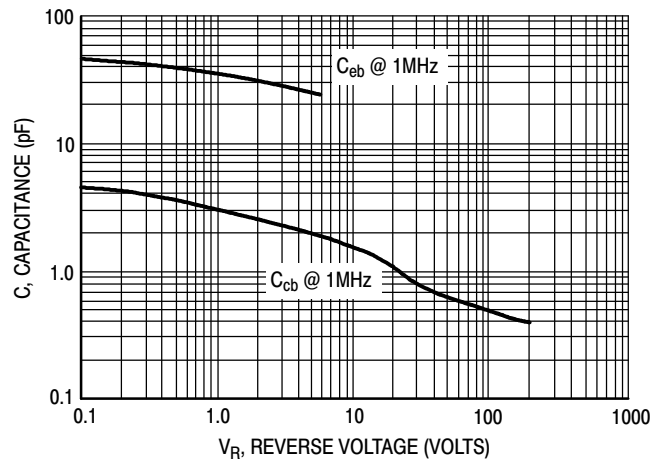

Figure 2. Capacitance

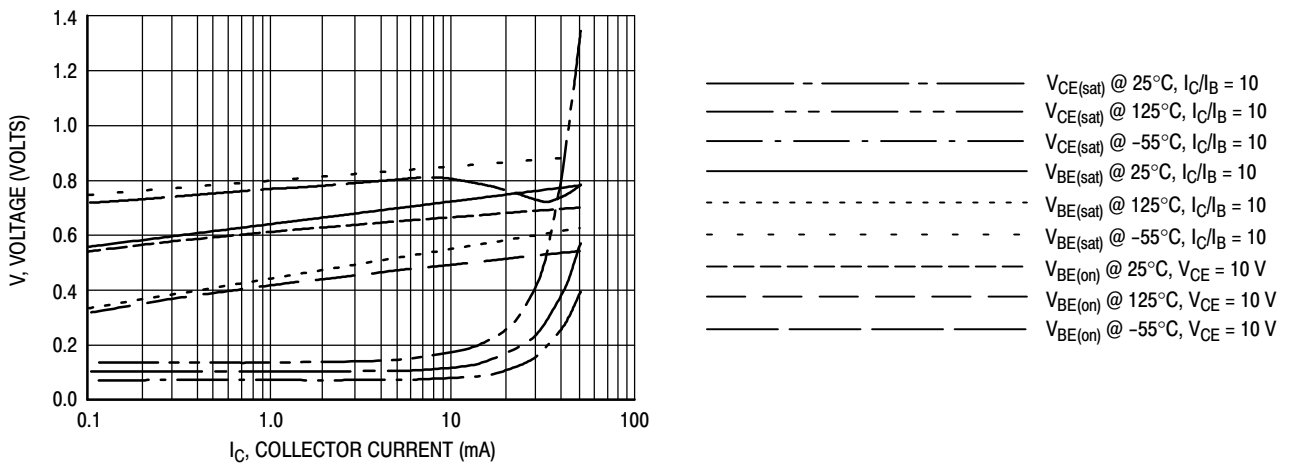
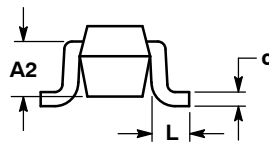
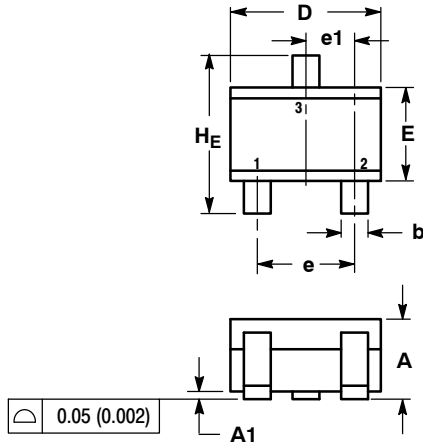

Figure 3. "ON" Voltages

# MSD42WT1G, MSD42T1G

## PACKAGE DIMENSIONS

SC-70 (SOT-323)  
CASE 419-04  
ISSUE N



NOTES:

1. DIMENSIONING AND TOLERANCING PER ANSI Y14.5M, 1982.
2. CONTROLLING DIMENSION: INCH.

DIM	MILLIMETERS			INCHES		
	MIN	NOM	MAX	MIN	NOM	MAX
A	0.80	0.90	1.00	0.032	0.035	0.040
A1	0.00	0.05	0.10	0.000	0.002	0.004
A2	0.70 REF			0.028 REF		
b	0.30	0.35	0.40	0.012	0.014	0.016
c	0.10	0.18	0.25	0.004	0.007	0.010
D	1.80	2.10	2.20	0.071	0.083	0.087
E	1.15	1.24	1.35	0.045	0.049	0.053
e	1.20	1.30	1.40	0.047	0.051	0.055
e1	0.65 BSC			0.026 BSC		
L	0.20	0.38	0.56	0.008	0.015	0.022
HE	2.00	2.10	2.40	0.079	0.083	0.095

STYLE 3:  
PIN 1. BASE  
2. EMITTER  
3. COLLECTOR

### SOLDERING FOOTPRINT\*

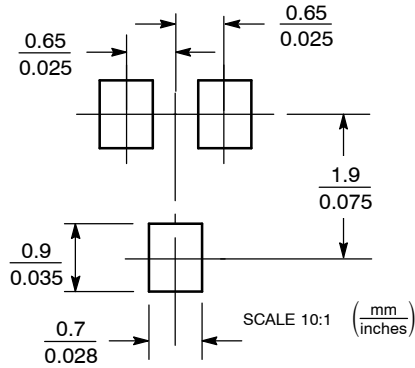

\*For additional information on our Pb-Free strategy and soldering details, please download the ON Semiconductor Soldering and Mounting Techniques Reference Manual, SOLDERRM/D.

# MSD42WT1G, MSD42T1G

## PACKAGE DIMENSIONS

SC-59  
CASE 318D-04  
ISSUE G

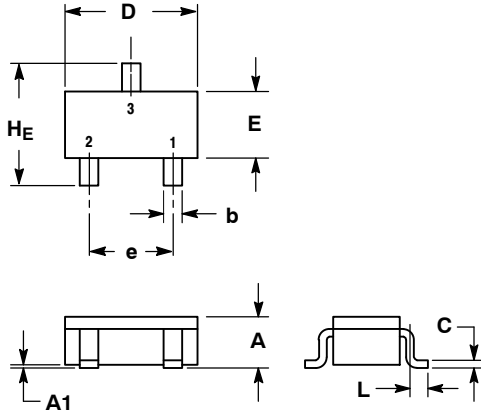

- NOTES:  
1. DIMENSIONING AND TOLERANCING PER ANSI Y14.5M, 1982.  
2. CONTROLLING DIMENSION: MILLIMETER.

DIM	MILLIMETERS			INCHES		
	MIN	NOM	MAX	MIN	NOM	MAX
A	1.00	1.15	1.30	0.039	0.045	0.051
A1	0.01	0.06	0.10	0.001	0.002	0.004
b	0.35	0.43	0.50	0.014	0.017	0.020
c	0.09	0.14	0.18	0.003	0.005	0.007
D	2.70	2.90	3.10	0.106	0.114	0.122
E	1.30	1.50	1.70	0.051	0.059	0.067
e	1.70	1.90	2.10	0.067	0.075	0.083
L	0.20	0.40	0.60	0.008	0.016	0.024
HE	2.50	2.80	3.00	0.099	0.110	0.118

### SOLDERING FOOTPRINT\*

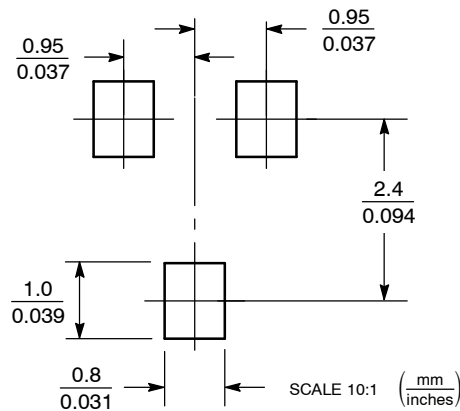

\*For additional information on our Pb-Free strategy and soldering details, please download the ON Semiconductor Soldering and Mounting Techniques Reference Manual, SOLDERRM/D.

ON Semiconductor and are registered trademarks of Semiconductor Components Industries, LLC (SCILLC). SCILLC reserves the right to make changes without further notice to any products herein. SCILLC makes no warranty, representation or guarantee regarding the suitability of its products for any particular purpose, nor does SCILLC assume any liability arising out of the application or use of any product or circuit, and specifically disclaims any and all liability, including without limitation special, consequential or incidental damages. "Typical" parameters which may be provided in SCILLC data sheets and/or specifications can and do vary in different applications and actual performance may vary over time. All operating parameters, including "Typicals" must be validated for each customer application by customer's technical experts. SCILLC does not convey any license under its patent rights nor the rights of others. SCILLC products are not designed, intended, or authorized for use as components in systems intended for surgical implant into the body, or other applications intended to support or sustain life, or for any other application in which the failure of the SCILLC product could create a situation where personal injury or death may occur. Should Buyer purchase or use SCILLC products for any such unintended or unauthorized application, Buyer shall indemnify and hold SCILLC and its officers, employees, subsidiaries, affiliates, and distributors harmless against all claims, costs, damages, and expenses, and reasonable attorney fees arising out of, directly or indirectly, any claim of personal injury or death associated with such unintended or unauthorized use, even if such claim alleges that SCILLC was negligent regarding the design or manufacture of the part. SCILLC is an Equal Opportunity/Affirmative Action Employer. This literature is subject to all applicable copyright laws and is not for resale in any manner.

### PUBLICATION ORDERING INFORMATION

**LITERATURE FULFILLMENT:**  
Literature Distribution Center for ON Semiconductor  
P.O. Box 5163, Denver, Colorado 80217 USA  
**Phone:** 303-675-2175 or 800-344-3860 Toll Free USA/Canada  
**Fax:** 303-675-2176 or 800-344-3867 Toll Free USA/Canada  
**Email:** orderlit@onsemi.com

**N. American Technical Support:** 800-282-9855 Toll Free  
USA/Canada  
**Europe, Middle East and Africa Technical Support:**  
Phone: 421 33 790 2910  
**Japan Customer Focus Center**  
Phone: 81-3-5773-3850

**ON Semiconductor Website:** [www.onsemi.com](http://www.onsemi.com)

**Order Literature:** <http://www.onsemi.com/orderlit>

For additional information, please contact your local Sales Representative

MSD42WT1/D