

Complementary power Darlington transistors

Features

- Good h_{FE} linearity
- High f_T frequency
- Monolithic Darlington configuration with integrated antiparallel collector-emitter diode

Application

- Linear and switching industrial equipment

Description

The devices are manufactured in planar technology with "base island" layout and monolithic Darlington configuration.

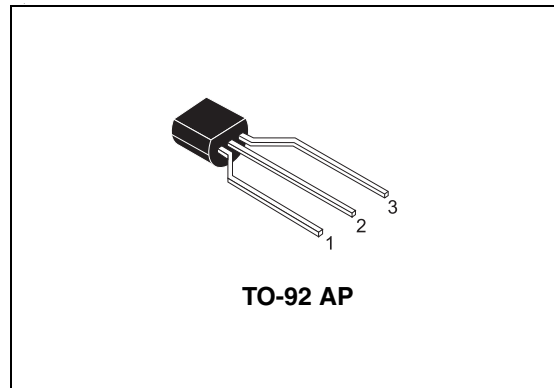

Figure 1. Internal schematic diagram

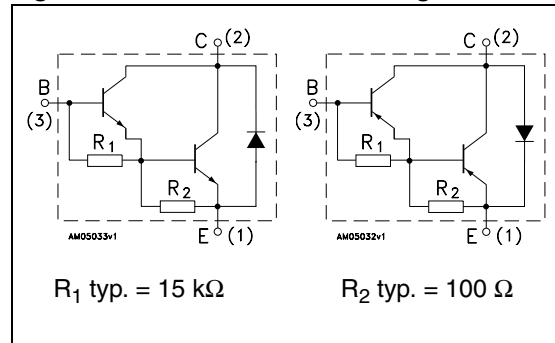

Table 1. Device summary

| Order codes | Marking | Polarity | Package | Packaging |
|-------------|---------|----------|---------|-----------|
| STX112-AP | X112 | NPN | TO92-AP | Ammopack |
| STX117-AP | X117 | PNP | TO92-AP | Ammopack |

1 Absolute maximum ratings

Table 2. Absolute maximum ratings

| Symbol | Parameter | Value | Unit |
|-----------|---|------------|------|
| V_{CBO} | Collector-base voltage ($I_E = 0$) | 100 | V |
| V_{CEO} | Collector-emitter voltage ($I_B = 0$) | | |
| V_{EBO} | Emitter-base voltage ($I_C = 0$) | 5 | V |
| I_C | Collector current | 2 | A |
| I_{CM} | Collector peak current | 4 | A |
| I_B | Base current | 0.05 | A |
| P_{TOT} | Total dissipation at $T_{amb} = 25\text{ °C}$ | 1.2 | W |
| T_{STG} | Storage temperature | -65 to 150 | °C |
| T_J | Max. operating junction temperature | 150 | °C |

Note: For PNP types voltage and current values are negative.

Table 3. Thermal data

| Symbol | Parameter | Value | Unit |
|------------|--|-------|------|
| R_{thJA} | Thermal resistance junction-ambient max. | 104 | °C/W |

2 Electrical characteristics

$T_{\text{case}} = 25\text{ }^{\circ}\text{C}$; unless otherwise specified.

Table 4. Electrical characteristics

| Symbol | Parameter | Test conditions | Min. | Typ. | Max. | Unit |
|-----------------------------|--|--|------|------|------|------|
| I_{CBO} | Collector cut-off current ($I_{\text{E}} = 0$) | $V_{\text{CB}} = 100\text{ V}$ | | - | 1 | mA |
| I_{CEO} | Collector cut-off current ($I_{\text{B}} = 0$) | $V_{\text{CE}} = 50\text{ V}$ | | - | 2 | mA |
| I_{EBO} | Emitter cut-off current ($I_{\text{C}} = 0$) | $V_{\text{EB}} = 5\text{ V}$ | | - | 2 | mA |
| $V_{\text{CEO(sus)}}^{(1)}$ | Collector-emitter sustaining voltage ($I_{\text{B}} = 0$) | $I_{\text{C}} = 30\text{ mA}$ | 100 | - | | V |
| $V_{\text{CE(sat)}}^{(1)}$ | Collector-emitter saturation voltage | $I_{\text{C}} = 2\text{ A}$ $I_{\text{B}} = 8\text{ mA}$ | | - | 2.5 | V |
| $V_{\text{BE(on)}}$ | Base-emitter on voltage | $I_{\text{C}} = 2\text{ A}$ $V_{\text{CE}} = 4\text{ V}$ | | - | 2.8 | V |
| $h_{\text{FE}}^{(1)}$ | DC current gain | $I_{\text{C}} = 1\text{ A}$ $V_{\text{CE}} = 4\text{ V}$ | 1000 | - | | |
| | | $I_{\text{C}} = 2\text{ A}$ $V_{\text{CE}} = 4\text{ V}$ | 500 | - | | |

1. Pulse test: pulse duration $\leq 300\text{ }\mu\text{s}$, duty cycle $\leq 2\%$

Note: For PNP types voltage and current values are negative.

2.1 Typical characteristic (curves)

**Figure 2. DC current gain
($V_{\text{CE}} = 3\text{ V NPN}$)**

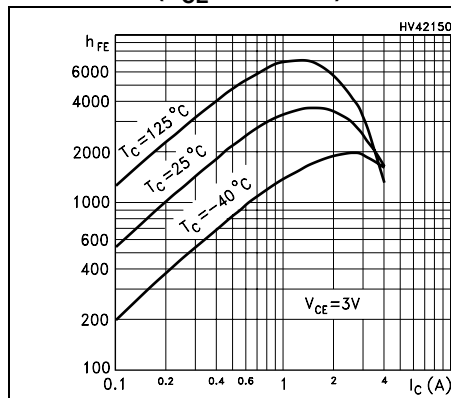

**Figure 3. DC current gain
($V_{\text{CE}} = -3\text{ V PNP}$)**

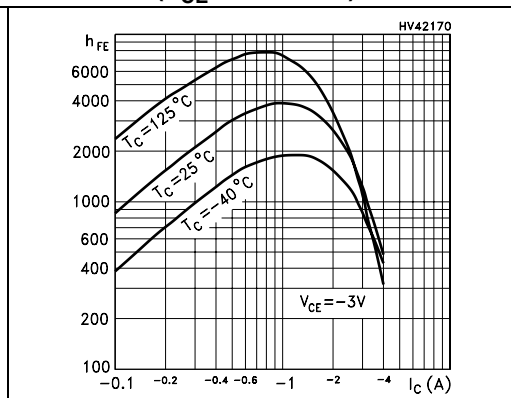

Figure 4. DC current gain ($V_{CE} = 5\text{ V NPN}$)

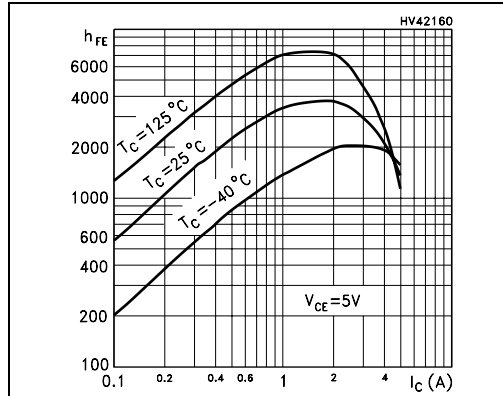

Figure 5. DC current gain ($V_{CE} = -5\text{ V PNP}$)

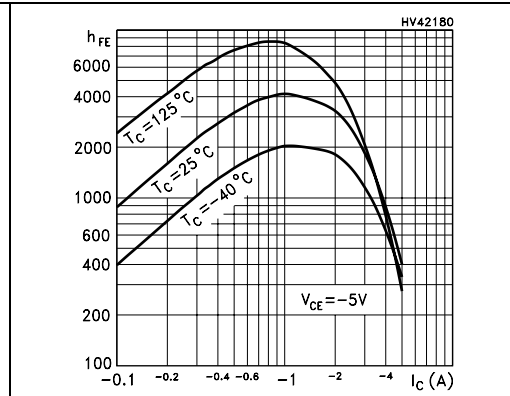

Figure 6. Collector-emitter saturation voltage (NPN)

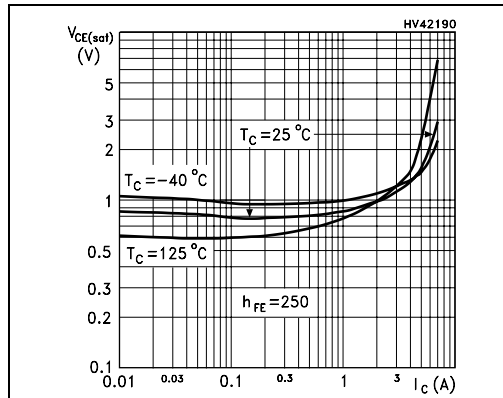

Figure 7. Collector-emitter saturation voltage (PNP)

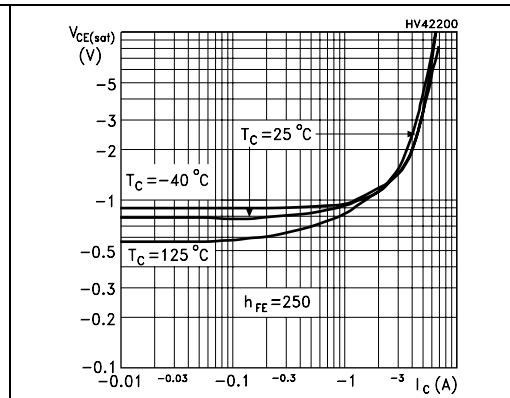

Figure 8. Base-emitter saturation voltage (NPN)

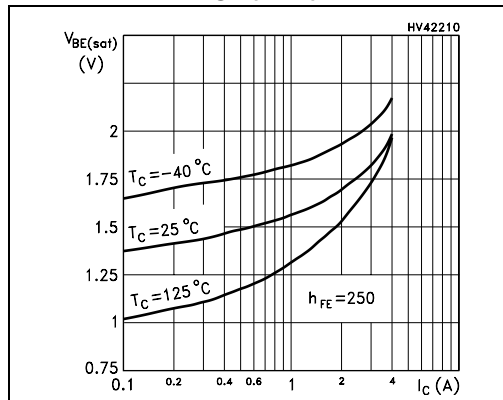

Figure 9. Base-emitter saturation voltage (PNP)

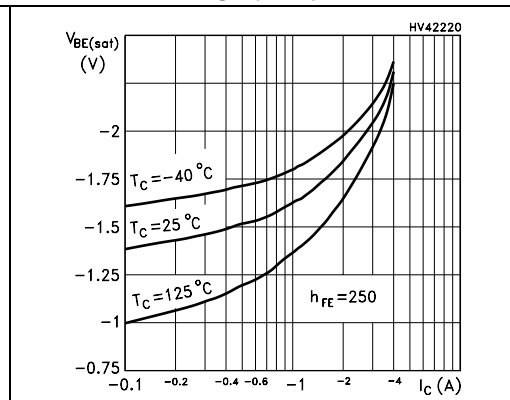

Figure 10. Base-emitter on voltage (NPN)

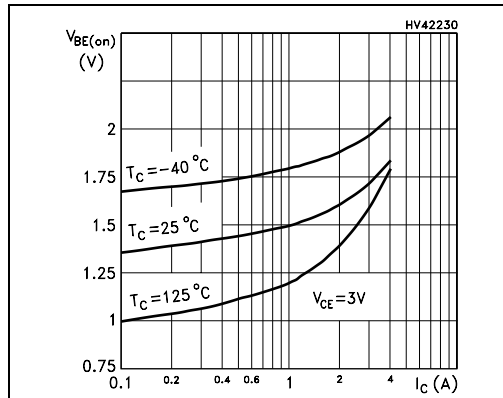

Figure 11. Base-emitter on voltage (PNP)

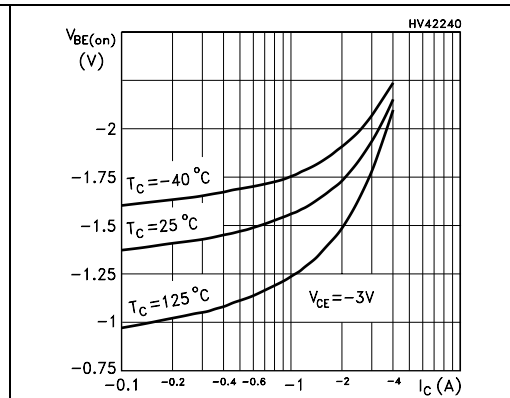

Figure 12. Resistive load switching time (NPN, on)

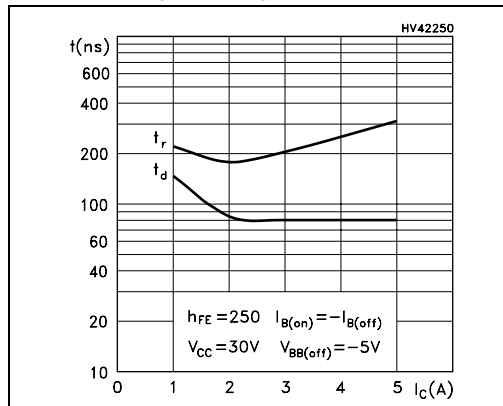

Figure 13. Resistive load switching time (PNP, on)

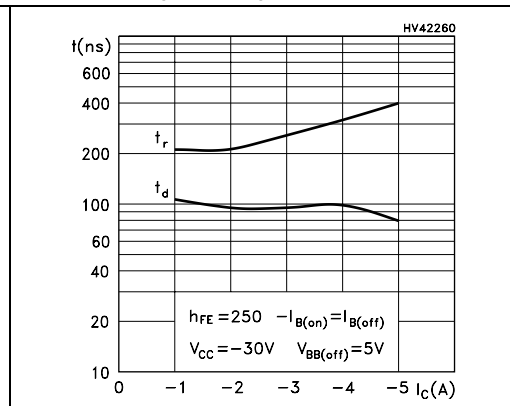

Figure 14. Resistive load switching time (NPN, off)

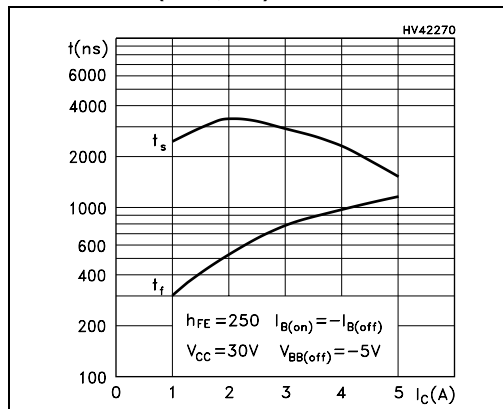
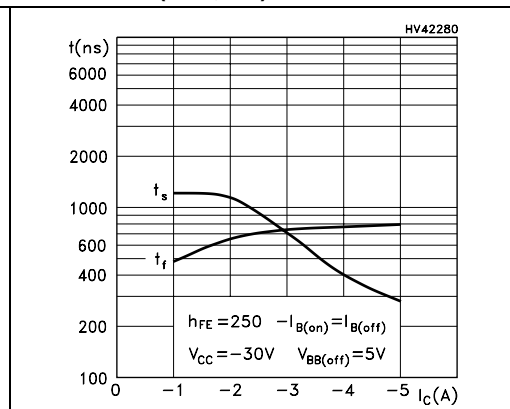

Figure 15. Resistive load switching time (PNP, off)



3 Package mechanical data

In order to meet environmental requirements, ST offers these devices in different grades of ECOPACK[®] packages, depending on their level of environmental compliance. ECOPACK[®] specifications, grade definitions and product status are available at: www.st.com. ECOPACK[®] is an ST trademark.

TO-92 ammopack shipment (suffix"-AP") mechanical data

| Dim. | mm. | | |
|---------|-------|-------|-------|
| | Min. | Typ. | Max. |
| A1 | | | 4.80 |
| T | | | 3.80 |
| T1 | | | 1.60 |
| T2 | | | 2.30 |
| d | | | 0.48 |
| P0 | 12.50 | 12.70 | 12.90 |
| P2 | 5.65 | 6.35 | 7.05 |
| F1,F2 | 2.44 | 2.54 | 2.94 |
| F3 | 4.98 | 5.08 | 5.48 |
| delta H | -2.00 | | 2.00 |
| W | 17.50 | 18.00 | 19.00 |
| W0 | 5.70 | 6.00 | 6.30 |
| W1 | 8.50 | 9.00 | 9.25 |
| W2 | | | 0.50 |
| H | 18.50 | | 20.50 |
| H3 | 0.5 | 1 | 1.5 |
| H0 | 15.50 | 16.00 | 16.50 |
| H1 | | | 25.00 |
| D0 | 3.80 | 4.00 | 4.20 |
| t | | | 0.90 |
| L | | | 11.00 |
| l1 | 3.00 | | |
| delta P | -1.00 | | 1.00 |

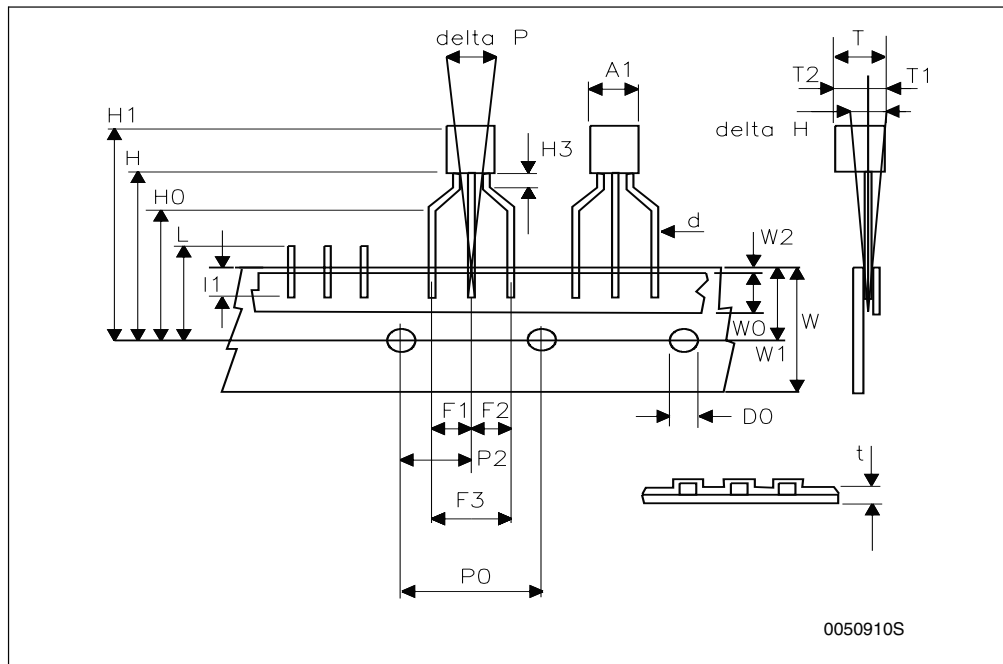

4 Revision history

Table 5. Document revision history

| Date | Revision | Changes |
|-------------|----------|----------------------------------|
| 21-Jan-2008 | 3 | |
| 07-Apr-2010 | 4 | Updated package mechanical data. |

Please Read Carefully:

Information in this document is provided solely in connection with ST products. STMicroelectronics NV and its subsidiaries ("ST") reserve the right to make changes, corrections, modifications or improvements, to this document, and the products and services described herein at any time, without notice.

All ST products are sold pursuant to ST's terms and conditions of sale.

Purchasers are solely responsible for the choice, selection and use of the ST products and services described herein, and ST assumes no liability whatsoever relating to the choice, selection or use of the ST products and services described herein.

No license, express or implied, by estoppel or otherwise, to any intellectual property rights is granted under this document. If any part of this document refers to any third party products or services it shall not be deemed a license grant by ST for the use of such third party products or services, or any intellectual property contained therein or considered as a warranty covering the use in any manner whatsoever of such third party products or services or any intellectual property contained therein.

UNLESS OTHERWISE SET FORTH IN ST'S TERMS AND CONDITIONS OF SALE ST DISCLAIMS ANY EXPRESS OR IMPLIED WARRANTY WITH RESPECT TO THE USE AND/OR SALE OF ST PRODUCTS INCLUDING WITHOUT LIMITATION IMPLIED WARRANTIES OF MERCHANTABILITY, FITNESS FOR A PARTICULAR PURPOSE (AND THEIR EQUIVALENTS UNDER THE LAWS OF ANY JURISDICTION), OR INFRINGEMENT OF ANY PATENT, COPYRIGHT OR OTHER INTELLECTUAL PROPERTY RIGHT.

UNLESS EXPRESSLY APPROVED IN WRITING BY AN AUTHORIZED ST REPRESENTATIVE, ST PRODUCTS ARE NOT RECOMMENDED, AUTHORIZED OR WARRANTED FOR USE IN MILITARY, AIR CRAFT, SPACE, LIFE SAVING, OR LIFE SUSTAINING APPLICATIONS, NOR IN PRODUCTS OR SYSTEMS WHERE FAILURE OR MALFUNCTION MAY RESULT IN PERSONAL INJURY, DEATH, OR SEVERE PROPERTY OR ENVIRONMENTAL DAMAGE. ST PRODUCTS WHICH ARE NOT SPECIFIED AS "AUTOMOTIVE GRADE" MAY ONLY BE USED IN AUTOMOTIVE APPLICATIONS AT USER'S OWN RISK.

Resale of ST products with provisions different from the statements and/or technical features set forth in this document shall immediately void any warranty granted by ST for the ST product or service described herein and shall not create or extend in any manner whatsoever, any liability of ST.

ST and the ST logo are trademarks or registered trademarks of ST in various countries.

Information in this document supersedes and replaces all information previously supplied.

The ST logo is a registered trademark of STMicroelectronics. All other names are the property of their respective owners.

© 2010 STMicroelectronics - All rights reserved

STMicroelectronics group of companies

Australia - Belgium - Brazil - Canada - China - Czech Republic - Finland - France - Germany - Hong Kong - India - Israel - Italy - Japan - Malaysia - Malta - Morocco - Philippines - Singapore - Spain - Sweden - Switzerland - United Kingdom - United States of America

www.st.com

