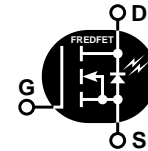
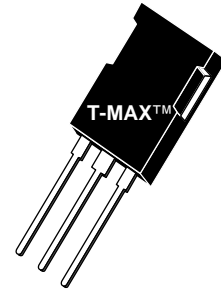


### POWER MOS V®

**FREDFET**

Power MOS V® is a new generation of high voltage N-Channel enhancement mode power MOSFETs. This new technology minimizes the JFET effect, increases packing density and reduces the on-resistance. Power MOS V® also achieves faster switching speeds through optimized gate layout.



- Fast Recovery Body Diode
- Lower Leakage
- Faster Switching
- 100% Avalanche Tested
- New T-MAX™ Package  
(Clip-mounted TO-247 Package)

#### MAXIMUM RATINGS

All Ratings:  $T_C = 25^\circ\text{C}$  unless otherwise specified.

| Symbol         | Parameter   | APT20M22B2VFR | UNIT  |
|----------------|---|---------------|-------|
| $V_{DSS}$      | Drain-Source Voltage                                  | 200           | Volts |
| $I_D$          | Continuous Drain Current @ $T_C = 25^\circ\text{C}$ ⑤ | 100           | Amps  |
| $I_{DM}$       | Pulsed Drain Current ① ⑤                              | 400           |       |
| $V_{GS}$       | Gate-Source Voltage Continuous                        | $\pm 30$      | Volts |
| $V_{GSM}$      | Gate-Source Voltage Transient                         | $\pm 40$      |       |
| $P_D$          | Total Power Dissipation @ $T_C = 25^\circ\text{C}$    | 520           | Watts |
|                | Linear Derating Factor                                | 4.16          | W/°C  |
| $T_J, T_{STG}$ | Operating and Storage Junction Temperature Range      | -55 to 150    | °C    |
| $T_L$          | Lead Temperature: 0.063" from Case for 10 Sec.        | 300           |       |
| $I_{AR}$       | Avalanche Current ① ⑤ (Repetitive and Non-Repetitive) | 100           | Amps  |
| $E_{AR}$       | Repetitive Avalanche Energy ①                         | 50            | mJ    |
| $E_{AS}$       | Single Pulse Avalanche Energy ④                       | 2500          |       |

#### STATIC ELECTRICAL CHARACTERISTICS

| Symbol       | Characteristic / Test Conditions   | MIN | TYP | MAX       | UNIT          |
|--------------|--|-----|-----|-----------|---------------|
| $BV_{DSS}$   | Drain-Source Breakdown Voltage ( $V_{GS} = 0V, I_D = 250\mu\text{A}$ )                           | 200 |     |           | Volts         |
| $I_{D(on)}$  | On State Drain Current ② ⑤ ( $V_{DS} > I_{D(on)} \times R_{DS(on)}$ Max, $V_{GS} = 10V$ )        | 100 |     |           | Amps          |
| $R_{DS(on)}$ | Drain-Source On-State Resistance ② ( $V_{GS} = 10V, 0.5 I_{D[Cont.]}$ )                          |     |     | 0.022     | Ohms          |
| $I_{DSS}$    | Zero Gate Voltage Drain Current ( $V_{DS} = V_{DSS}, V_{GS} = 0V$ )                              |     |     | 250       | $\mu\text{A}$ |
|              | Zero Gate Voltage Drain Current ( $V_{DS} = 0.8 V_{DSS}, V_{GS} = 0V, T_C = 125^\circ\text{C}$ ) |     |     | 1000      |               |
| $I_{GSS}$    | Gate-Source Leakage Current ( $V_{GS} = \pm 30V, V_{DS} = 0V$ )                                  |     |     | $\pm 100$ | nA            |
| $V_{GS(th)}$ | Gate Threshold Voltage ( $V_{DS} = V_{GS}, I_D = 2.5\text{mA}$ )                                 | 2   |     | 4         | Volts         |

 **CAUTION:** These Devices are Sensitive to Electrostatic Discharge. Proper Handling Procedures Should Be Followed.

**USA**  
405 S.W. Columbia Street

**EUROPE**  
Avenue J.F. Kennedy Bât B4 Parc Cadéra Nord

**APT Website - <http://www.advancedpower.com>**

Bend, Oregon 97702-1035

Phone: (541) 382-8028

FAX: (541) 388-0364

F-33700 Merignac - France

Phone: (33) 5 57 92 15 15

FAX: (33) 5 56 47 97 61

**DYNAMIC CHARACTERISTICS**

**APT20M22B2VFR**

| Symbol              | Characteristic               | Test Conditions                                | MIN | TYP  | MAX   | UNIT |
|---------------------|------------------------------|--|-----|------|-------|------|
| C <sub>iss</sub>    | Input Capacitance            | V <sub>GS</sub> = 0V                           |     | 8500 | 10200 | pF   |
| C <sub>oss</sub>    | Output Capacitance           | V <sub>DS</sub> = 25V                          |     | 1950 | 2730  |      |
| C <sub>rss</sub>    | Reverse Transfer Capacitance | f = 1 MHz                                      |     | 560  | 840   |      |
| Q <sub>g</sub>      | Total Gate Charge ③          | V <sub>GS</sub> = 10V                          |     | 290  | 435   | nC   |
| Q <sub>gs</sub>     | Gate-Source Charge           | V <sub>DD</sub> = 0.5 V <sub>DSS</sub>         |     | 66   | 100   |      |
| Q <sub>gd</sub>     | Gate-Drain ("Miller") Charge | I <sub>D</sub> = I <sub>D</sub> [Cont.] @ 25°C |     | 120  | 180   |      |
| t <sub>d(on)</sub>  | Turn-on Delay Time           | V <sub>GS</sub> = 15V                          |     | 16   | 32    | ns   |
| t <sub>r</sub>      | Rise Time                    | V <sub>DD</sub> = 0.5 V <sub>DSS</sub>         |     | 25   | 50    |      |
| t <sub>d(off)</sub> | Turn-off Delay Time          | I <sub>D</sub> = I <sub>D</sub> [Cont.] @ 25°C |     | 48   | 72    |      |
| t <sub>f</sub>      | Fall Time                    | R <sub>G</sub> = 0.6Ω                          |     | 5    | 10    |      |

**SOURCE-DRAIN DIODE RATINGS AND CHARACTERISTICS**

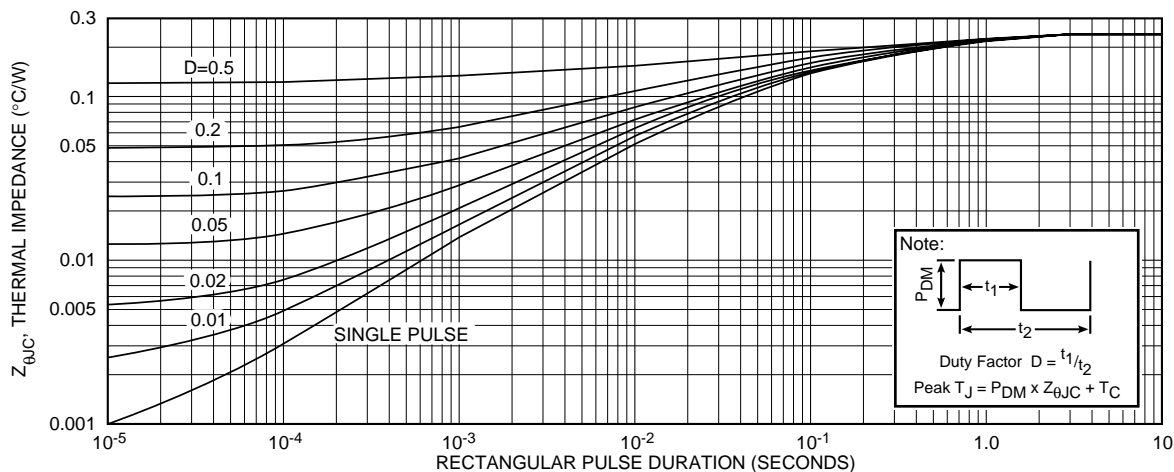
| Symbol           | Characteristic / Test Conditions   | MIN                    | TYP | MAX | UNIT  |
|------------------|--|------------------------|-----|-----|-------|
| I <sub>S</sub>   | Continuous Source Current (Body Diode)   |                        |     | 100 | Amps  |
| I <sub>SM</sub>  | Pulsed Source Current ① (Body Diode)   |                        |     | 400 |       |
| V <sub>SD</sub>  | Diode Forward Voltage ② (V <sub>GS</sub> = 0V, I <sub>S</sub> = -I <sub>D</sub> [Cont.]) |                        |     | 1.5 | Volts |
| dv/dt            | Peak Diode Recovery dv/dt ⑥  |                        |     | 5   | V/ns  |
| t <sub>rr</sub>  | Reverse Recovery Time<br>(I <sub>S</sub> = -I <sub>D</sub> [Cont.], di/dt = 100A/μs)     | T <sub>j</sub> = 25°C  |     | 220 | ns    |
|                  |  | T <sub>j</sub> = 125°C |     | 420 |       |
| Q <sub>rr</sub>  | Reverse Recovery Charge<br>(I <sub>S</sub> = -I <sub>D</sub> [Cont.], di/dt = 100A/μs)   | T <sub>j</sub> = 25°C  | 0.8 |     | μC    |
|                  |  | T <sub>j</sub> = 125°C | 3.0 |     |       |
| I <sub>RRM</sub> | Peak Recovery Current<br>(I <sub>S</sub> = -I <sub>D</sub> [Cont.], di/dt = 100A/μs)     | T <sub>j</sub> = 25°C  | 10  |     | Amps  |
|                  |  | T <sub>j</sub> = 125°C | 18  |     |       |

**THERMAL CHARACTERISTICS**

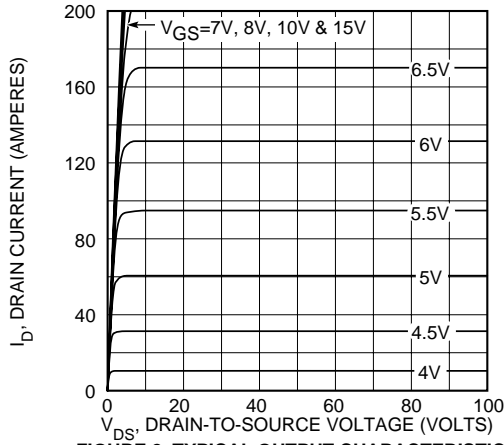
| Symbol           | Characteristic      | MIN | TYP | MAX  | UNIT |
|------------------|---------------------|-----|-----|------|------|
| R <sub>θJC</sub> | Junction to Case    |     |     | 0.24 | °C/W |
| R <sub>θJA</sub> | Junction to Ambient |     |     | 40   |      |

- ① Repetitive Rating: Pulse width limited by maximum junction temperature.
- ② Pulse Test: Pulse width < 380 μs, Duty Cycle < 2%
- ③ See MIL-STD-750 Method 3471
- ④ Starting T<sub>j</sub> = +25°C, L = 500μH, R<sub>G</sub> = 25Ω, Peak I<sub>L</sub> = 100A
- ⑤ These dimensions are equal to the TO-247 without mounting hole
- ⑥ I<sub>S</sub> ≤ -I<sub>D</sub> [Cont.], di/dt = 100A/μs, V<sub>DD</sub> ≤ V<sub>DSS</sub>, T<sub>j</sub> ≤ 150°C, R<sub>G</sub> = 2.0Ω, V<sub>R</sub> = 200V.

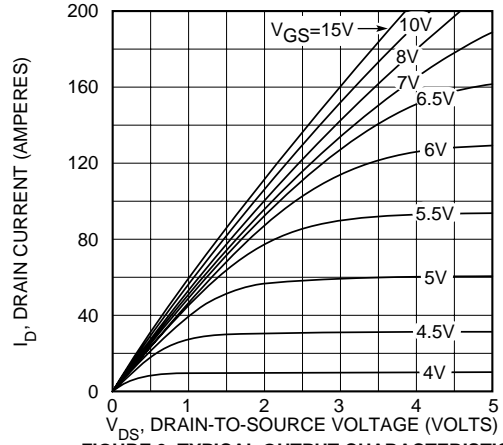
APT Reserves the right to change, without notice, the specifications and information contained herein.



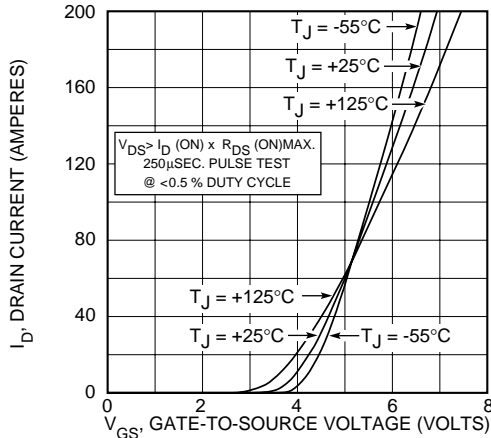
**APT20M22B2VFR**



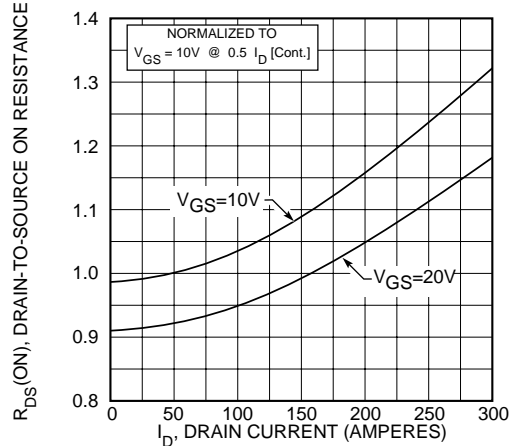
**FIGURE 2, TYPICAL OUTPUT CHARACTERISTICS**



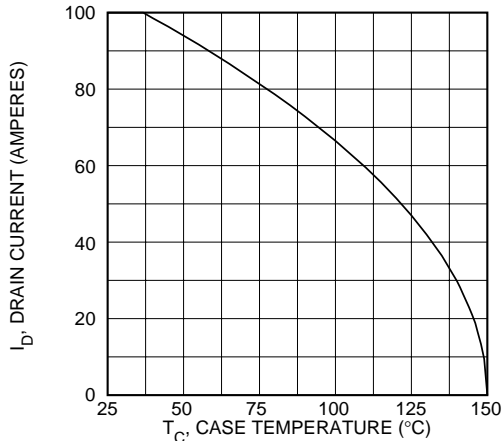
**FIGURE 3, TYPICAL OUTPUT CHARACTERISTICS**



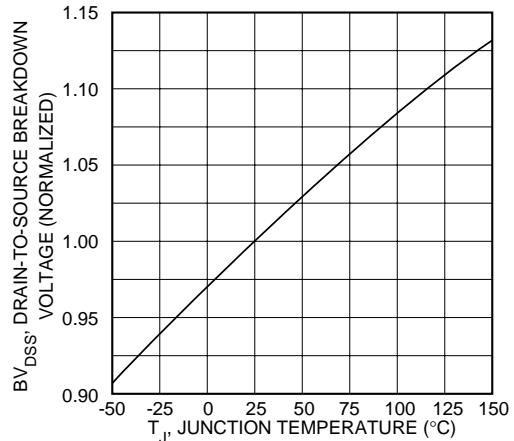
**FIGURE 4, TYPICAL TRANSFER CHARACTERISTICS**



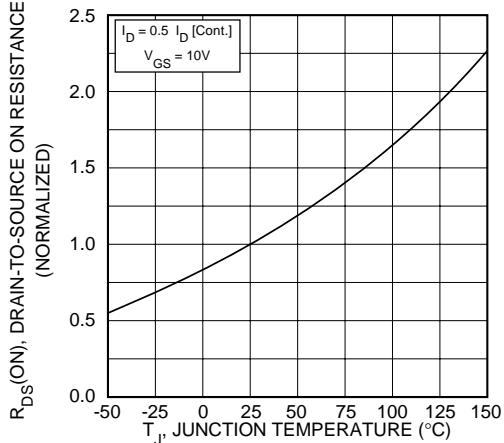
**FIGURE 5,  $R_{DS(ON)}$  vs DRAIN CURRENT**



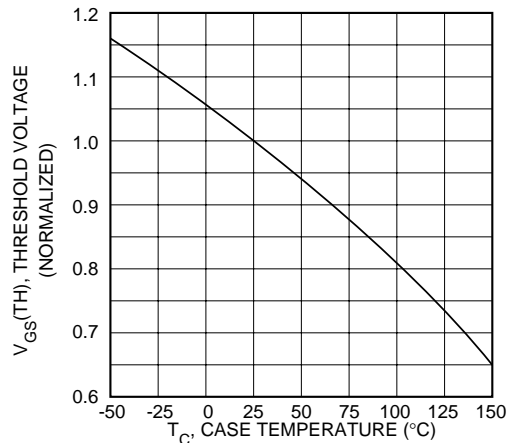
**FIGURE 6, MAXIMUM DRAIN CURRENT vs CASE TEMPERATURE**



**FIGURE 7, BREAKDOWN VOLTAGE vs TEMPERATURE**

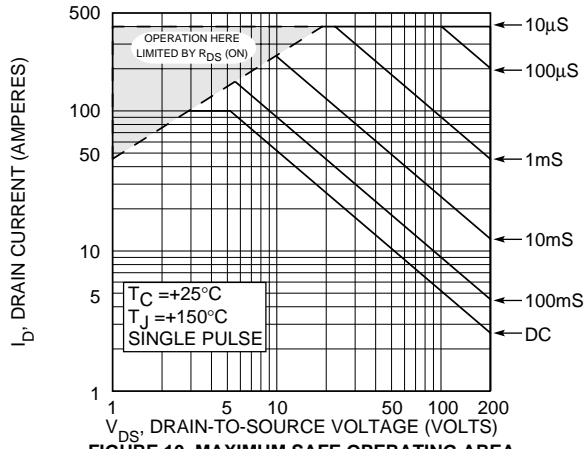


**FIGURE 8, ON-RESISTANCE vs. TEMPERATURE**

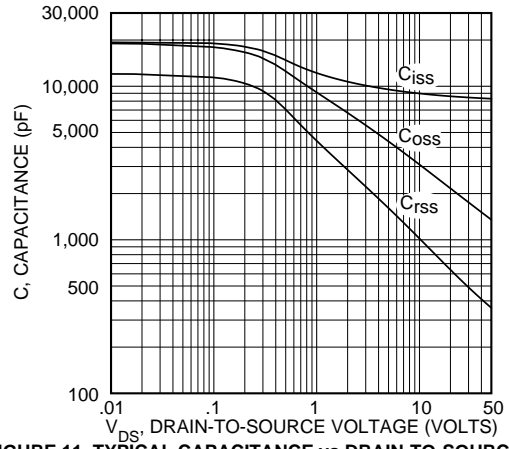


**FIGURE 9, THRESHOLD VOLTAGE vs TEMPERATURE**

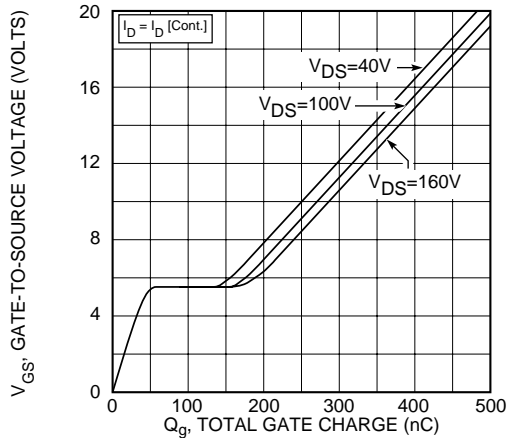
**APT20M22B2VFR**



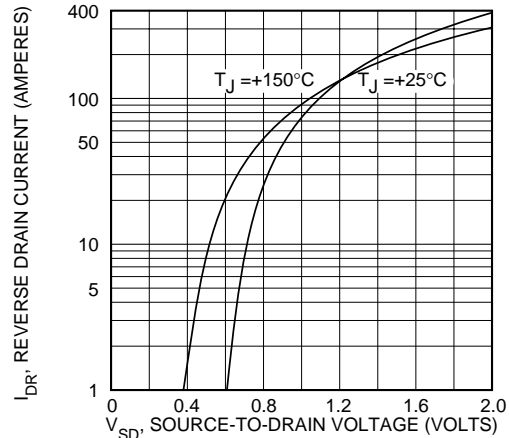
**FIGURE 10, MAXIMUM SAFE OPERATING AREA**



**FIGURE 11, TYPICAL CAPACITANCE vs DRAIN-TO-SOURCE VOLTAGE**

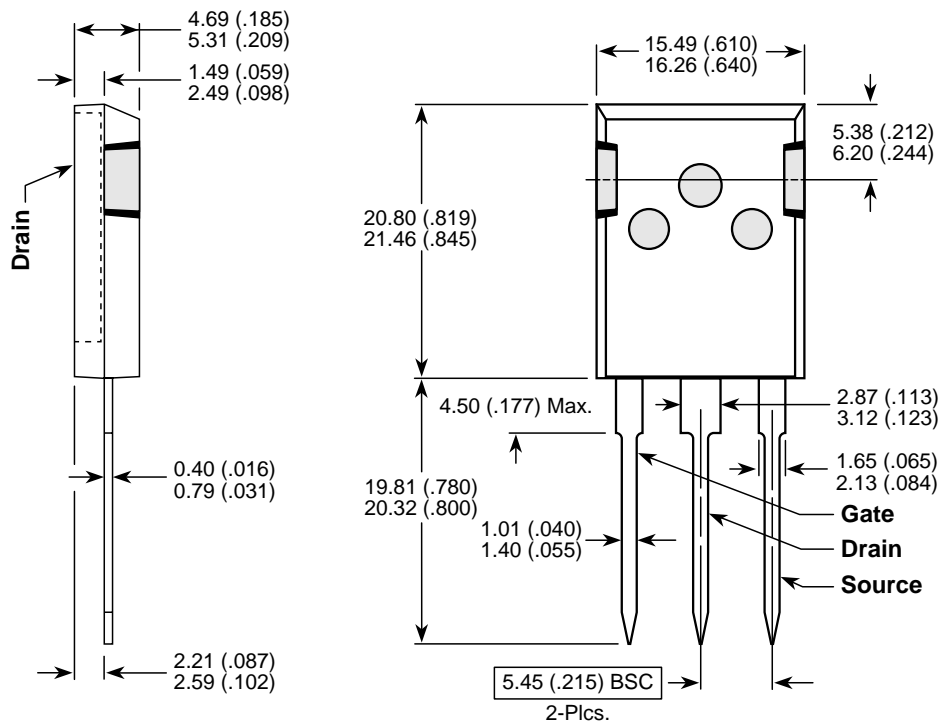


**FIGURE 12, GATE CHARGES vs GATE-TO-SOURCE VOLTAGE**



**FIGURE 13, TYPICAL SOURCE-DRAIN DIODE FORWARD VOLTAGE**

**T-MAX™ Package Outline ⑤**



Dimensions in Millimeters and (Inches)