

MMBTA13 MMBTA14

NPN Darlington Amplifier Transistor

Features

- Operating And Storage Temperatures -55°C to $+150^{\circ}\text{C}$
- $R_{\theta JA}$ is 556°C/W (Mounted on FR-5 PCB $1.0" \times 0.75" \times 0.062"$)
- Capable of 225mWatts of Power Dissipation
- Marking: MMBTA13 ---K2D; MMBTA14 ---K3D
- Lead Free Finish/RoHS Compliant ("P" Suffix designates RoHS Compliant. See ordering information)
- Epoxy meets UL 94 V-0 flammability rating
- Moisture Sensitivity Level 1

Electrical Characteristics @ 25°C Unless Otherwise Specified

Symbol	Parameter	Min	Max	Units
--------	-----------	-----	-----	-------

OFF CHARACTERISTICS

$V_{(BR)CEO}$	Collector-Emitter Breakdown Voltage* ($I_C=100\mu\text{A}$, $I_B=0$)	30		Vdc
$V_{(BR)CBO}$	Collector-Base Breakdown Voltage	30		Vdc
$V_{(BR)EBO}$	Emitter-Base Breakdown Voltage	10		Vdc
I_C	Collector Current-Continuous	300		mAdc
I_{CBO}	Collector Cutoff Current ($V_{CB}=30\text{Vdc}$, $I_E=0$)		100	nAdc
I_{EBO}	Emitter Cutoff Current ($V_{EB}=10\text{Vdc}$, $I_C=0$)		100	nAdc

ON CHARACTERISTICS

h_{FE}	DC Current Gain*			
MMBTA13 MMBTA14	($I_C=10\text{mAdc}$, $V_{CE}=5.0\text{Vdc}$)	5000 10000		
MMBTA13 MMBTA14	($I_C=150\text{mAdc}$, $V_{CE}=1.0\text{Vdc}$)	10000 20000		
$V_{CE(sat)}$	Collector-Emitter Saturation Voltage ($I_C=100\text{mAdc}$, $I_B=0.1\text{mAdc}$)		1.5	Vdc
$V_{BE(sat)}$	Base-Emitter Saturation Voltage ($I_C=100\text{mAdc}$, $V_{CE}=5.0\text{Vdc}$)		2.0	Vdc

SMALL-SIGNAL CHARACTERISTICS

f_T	Current Gain-Bandwidth Product ($I_C=10\text{mAdc}$, $V_{CE}=5.0\text{Vdc}$, $f=100\text{MHz}$)	125		MHz
C_{obo}	Output Capacitance ($V_{CB}=10\text{Vdc}$, $I_E=0$, $f=1.0\text{MHz}$)		8.0	pF
C_{ibo}	Input Capacitance ($V_{BE}=0.5\text{Vdc}$, $I_C=0$, $f=1.0\text{MHz}$)		15	pF

SWITCHING CHARACTERISTICS

t_d	Delay Time	($V_{CC}=30\text{Vdc}$, $V_{BE}=0.5\text{Vdc}$)	10	ns
t_r	Rise Time	($I_C=150\text{mAdc}$, $I_B=15\text{mAdc}$)	25	ns
t_s	Storage Time	($V_{CC}=30\text{Vdc}$, $I_C=150\text{mAdc}$)	225	ns
t_f	Fall Time	($I_{B1}=I_{B2}=15\text{mAdc}$)	60	ns

SOT-23

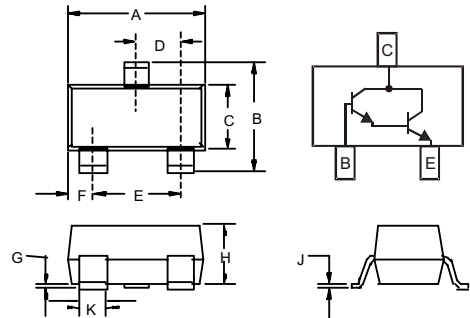

DIM	INCHES		MM		NOTE
	MIN	MAX	MIN	MAX	
A	.110	.120	2.80	3.04	
B	.083	.098	2.10	2.64	
C	.047	.055	1.20	1.40	
D	.035	.041	.89	1.03	
E	.070	.081	1.78	2.05	
F	.018	.024	.45	.60	
G	.0005	.0039	.013	.100	
H	.035	.044	.89	1.12	
J	.003	.007	.085	.180	
K	.015	.020	.37	.51	

Suggested Solder Pad Layout

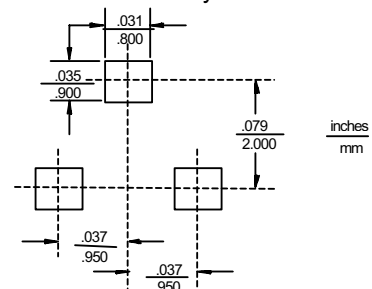

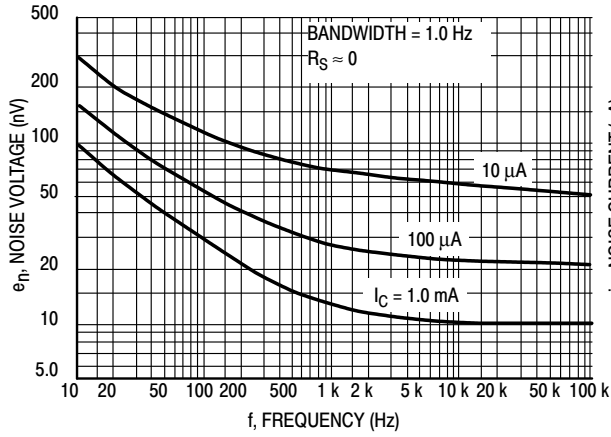

Figure 2. Noise Voltage

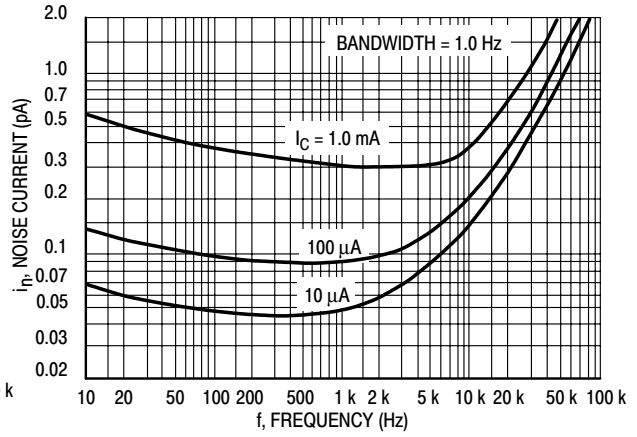

Figure 3. Noise Current

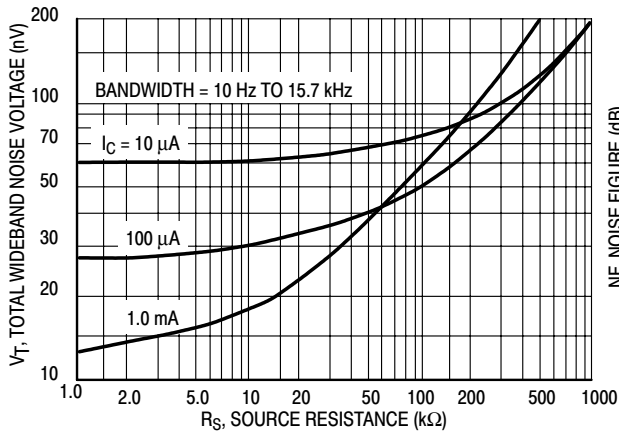

Figure 4. Total Wideband Noise Voltage

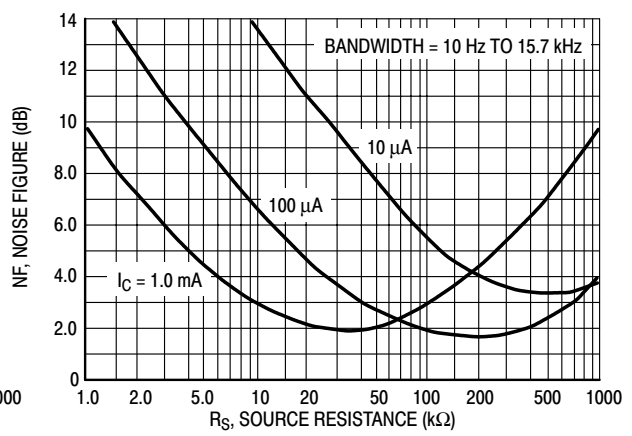

Figure 5. Wideband Noise Figure

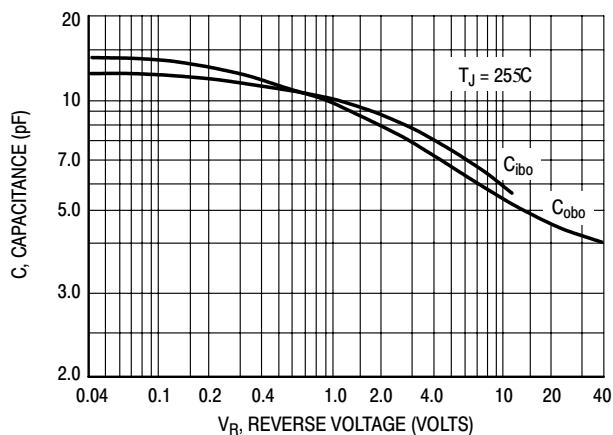

Figure 6. Capacitance

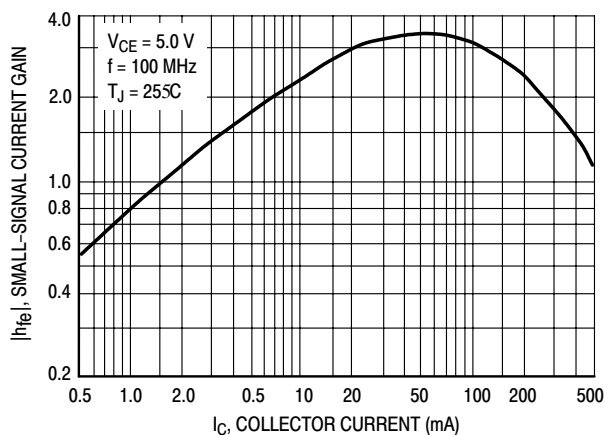

Figure 7. High Frequency Current Gain

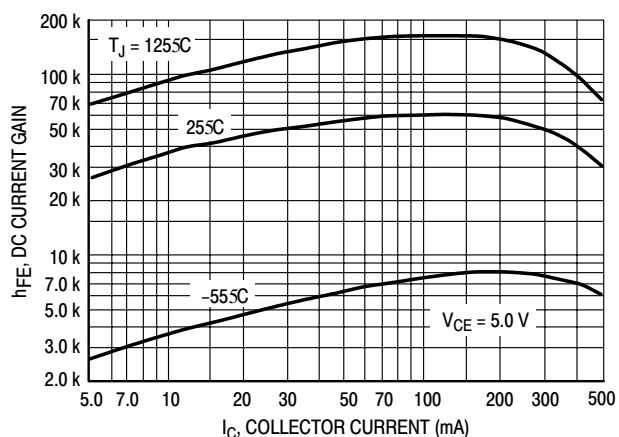

Figure 8. DC Current Gain

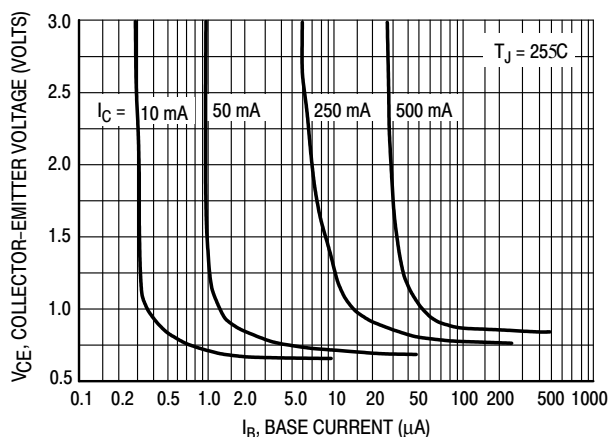

Figure 9. Collector Saturation Region

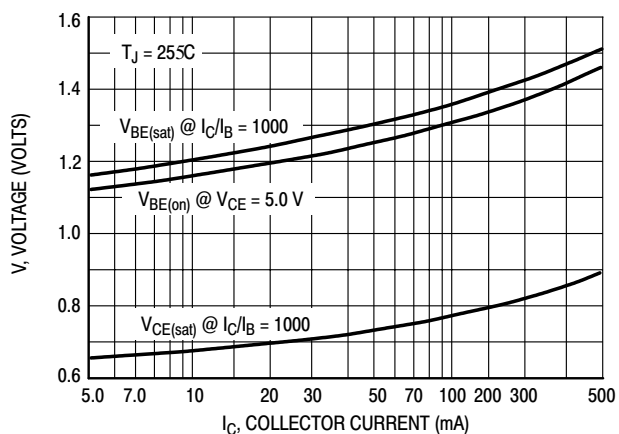

Figure 10. "On" Voltages

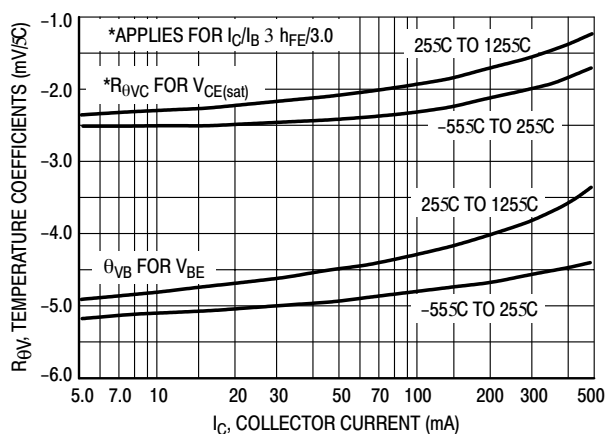

Figure 11. Temperature Coefficients

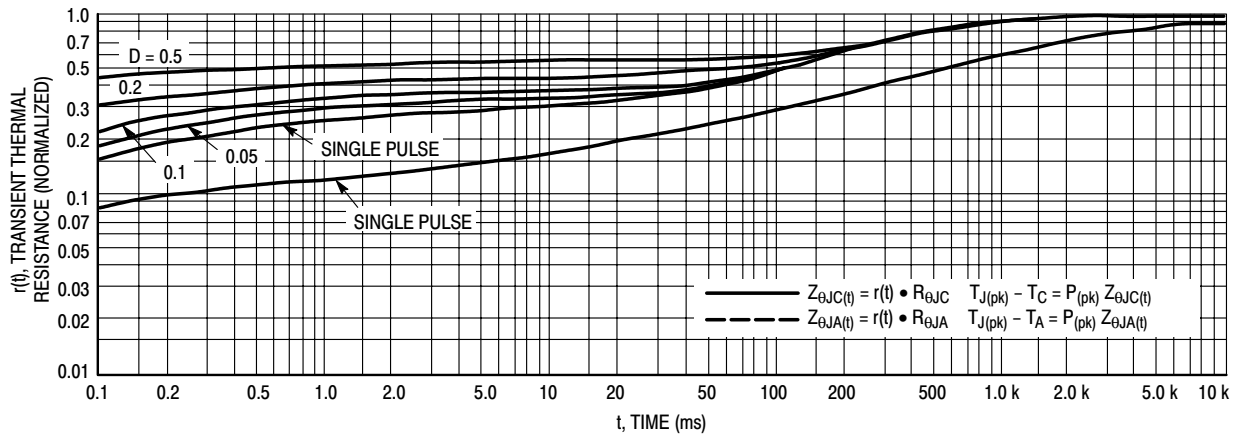

Figure 12. Thermal Response

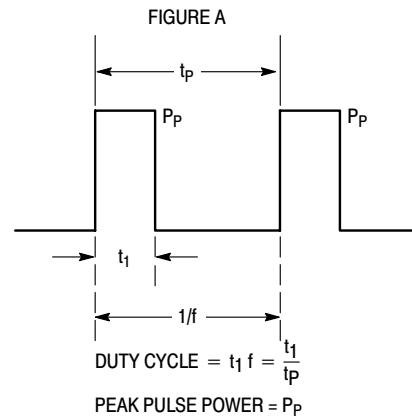
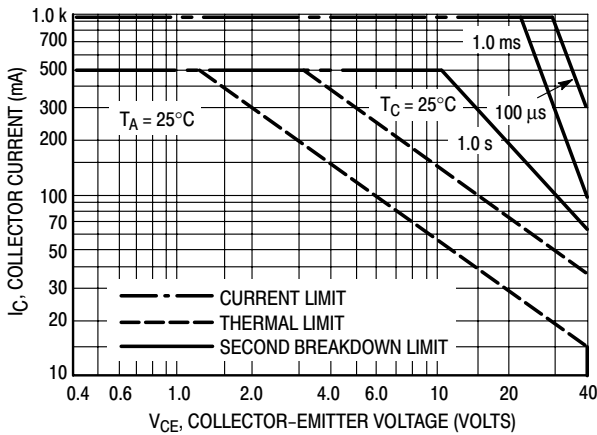

Figure 13. Active Region Safe Operating Area Design Note: Use of Transient Thermal Resistance Data



Micro Commercial Components

Ordering Information :

Device	Packing
Part Number-TP	Tape&Reel; 3Kpcs/Reel

IMPORTANT NOTICE

Micro Commercial Components Corp. reserves the right to make changes without further notice to any product herein to make corrections, modifications , enhancements , improvements , or other changes . **Micro Commercial Components Corp .** does not assume any liability arising out of the application or use of any product described herein; neither does it convey any license under its patent rights , nor the rights of others . The user of products in such applications shall assume all risks of such use and will agree to hold **Micro Commercial Components Corp .** and all the companies whose products are represented on our website, harmless against all damages.

LIFE SUPPORT

MCC's products are not authorized for use as critical components in life support devices or systems without the express written approval of Micro Commercial Components Corporation.

CUSTOMER AWARENESS

Counterfeiting of semiconductor parts is a growing problem in the industry. Micro Commercial Components (MCC) is taking strong measures to protect ourselves and our customers from the proliferation of counterfeit parts. MCC strongly encourages customers to purchase MCC parts either directly from MCC or from Authorized MCC Distributors who are listed by country on our web page cited below. Products customers buy either from MCC directly or from Authorized MCC Distributors are genuine parts, have full traceability, meet MCC's quality standards for handling and storage. **MCC will not provide any warranty coverage or other assistance for parts bought from Unauthorized Sources.** MCC is committed to combat this global problem and encourage our customers to do their part in stopping this practice by buying direct or from authorized distributors.

www.mccsemi.com