

## Features

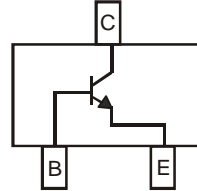
- Ideal for Medium Power Amplification and Switching
- Ultra Low Collector-Emitter Saturation Voltage
- Complimentary NPN Type Available (DSS5240T)
- **Lead Free By Design/RoHS Compliant (Note 1)**
- **“Green” Device (Note 2)**

## Mechanical Data

- Case: SOT-23
- Case Material: Molded Plastic, "Green" Molding Compound. UL Flammability Classification Rating 94V-0
- Moisture Sensitivity: Level 1 per J-STD-020D
- Terminals: Finish — Matte Tin annealed over Copper leadframe. Solderable per MIL-STD-202, Method 208
- Marking Information: See Page 4
- Ordering Information: See Page 4
- Weight: 0.008 grams (approximate)



Top View



Device Schematic

## Maximum Ratings @ $T_A = 25^\circ\text{C}$ unless otherwise specified

Characteristic	Symbol	Value	Unit
Collector-Base Voltage	$V_{CBO}$	40	V
Collector-Emitter Voltage	$V_{CEO}$	40	V
Emitter-Base Voltage	$V_{EBO}$	5	V
Peak Pulse Collector Current	$I_{CM}$	3	A
Continuous Collector Current	$I_C$	2	A
Peak Base Current	$I_{BM}$	0.3	A

## Thermal Characteristics

Characteristic	Symbol	Value	Unit
Power Dissipation (Note 3) @ $T_A = 25^\circ\text{C}$	$P_D$	600	mW
Thermal Resistance, Junction to Ambient Air (Note 3) @ $T_A = 25^\circ\text{C}$	$R_{\theta JA}$	209	$^\circ\text{C}/\text{W}$
Operating and Storage Temperature Range	$T_J, T_{STG}$	-55 to +150	$^\circ\text{C}$

- Notes:
1. No purposefully added lead.
  2. Diodes Inc.'s "Green" policy can be found on our website at [http://www.diodes.com/products/lead\\_free/index.php](http://www.diodes.com/products/lead_free/index.php).
  3. Device mounted on FR-4 PCB with minimum recommended pad layout, which can be found on our website at <http://www.diodes.com/datasheets/ap02001.pdf>.

**Electrical Characteristics** @ $T_A = 25^\circ\text{C}$  unless otherwise specified

Characteristic	Symbol	Min	Typ	Max	Unit	Test Conditions
<b>OFF CHARACTERISTICS</b>						
Collector-Base Breakdown Voltage	$V_{(BR)CBO}$	40	—	—	V	$I_C = 100\mu\text{A}$
Collector-Emitter Breakdown Voltage (Note 4)	$V_{(BR)CEO}$	40	—	—	V	$I_C = 10\text{mA}$
Emitter-Base Breakdown Voltage	$V_{(BR)EBO}$	5	—	—	V	$I_E = 100\mu\text{A}$
Collector-Base Cutoff Current	$I_{CBO}$	—	—	100	nA	$V_{CB} = 30\text{V}, I_E = 0$
		—	—	50	$\mu\text{A}$	$V_{CB} = 30\text{V}, I_E = 0, T_A = 150^\circ\text{C}$
Emitter-Base Cutoff Current	$I_{EBO}$	—	—	100	nA	$V_{EB} = 4\text{V}, I_C = 0$
<b>ON CHARACTERISTICS (Note 4)</b>						
DC Current Gain	$h_{FE}$	350	—	—	—	$V_{CE} = 2\text{V}, I_C = 0.1\text{A}$
		300	—	—	—	$V_{CE} = 2\text{V}, I_C = 0.5\text{A}$
		300	—	—	—	$V_{CE} = 2\text{V}, I_C = 1\text{A}$
		150	—	—	—	$V_{CE} = 2\text{V}, I_C = 2\text{A}$
Collector-Emitter Saturation Voltage	$V_{CE(SAT)}$	—	—	70	mV	$I_C = 100\text{mA}, I_B = 1\text{mA}$
		—	30	100		$I_C = 500\text{mA}, I_B = 50\text{mA}$
		—	—	180		$I_C = 750\text{mA}, I_B = 15\text{mA}$
		—	—	180		$I_C = 1\text{A}, I_B = 50\text{mA}$
		—	—	320		$I_C = 2\text{A}, I_B = 200\text{mA}$
Equivalent On-Resistance	$R_{CE(SAT)}$	—	60	200	m $\Omega$	$I_C = 500\text{mA}, I_B = 50\text{mA}$
Base-Emitter Saturation Voltage	$V_{BE(SAT)}$	—	—	1.1	V	$I_C = 2\text{A}, I_B = 200\text{mA}$
Base-Emitter Turn-on Voltage	$V_{BE(ON)}$	—	—	0.75	V	$V_{CE} = 2\text{V}, I_C = 100\text{mA}$
<b>SMALL SIGNAL CHARACTERISTICS</b>						
Transition Frequency	$f_T$	100	—	—	MHz	$V_{CE} = 10\text{V}, I_C = 100\text{mA}, f = 100\text{MHz}$
Output Capacitance	$C_{ob}$	—	—	20	pF	$V_{CB} = 10\text{V}, f = 1\text{MHz}$

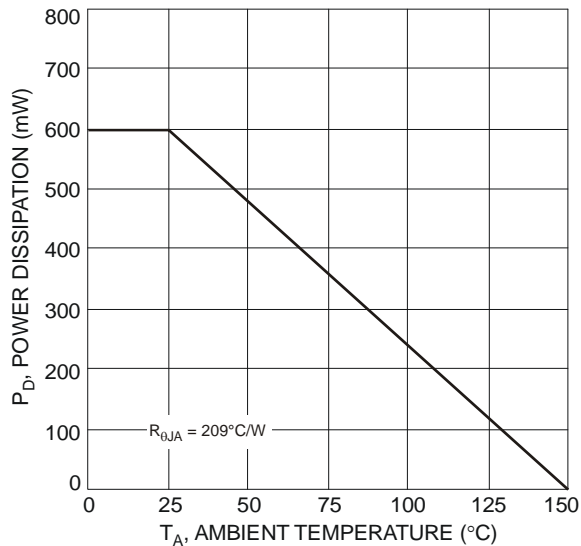
 Notes: 4. Measured under pulsed conditions. Pulse width = 300 $\mu\text{s}$ . Duty cycle  $\leq 2\%$ .


Fig. 1 Power Dissipation vs. Ambient Temperature (Note 3)

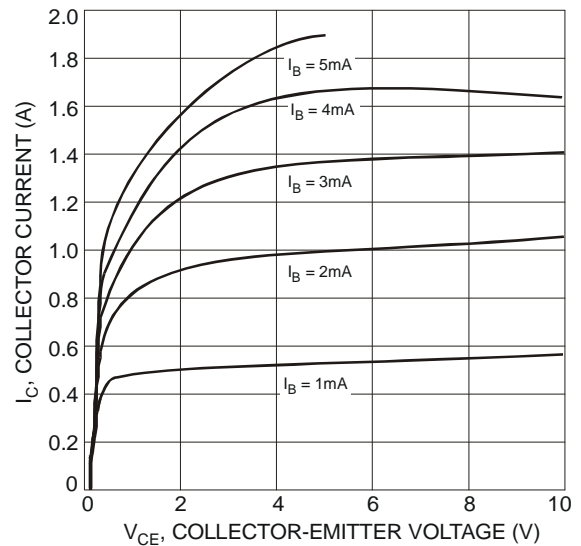


Fig. 2 Typical Collector Current vs. Collector-Emitter Voltage

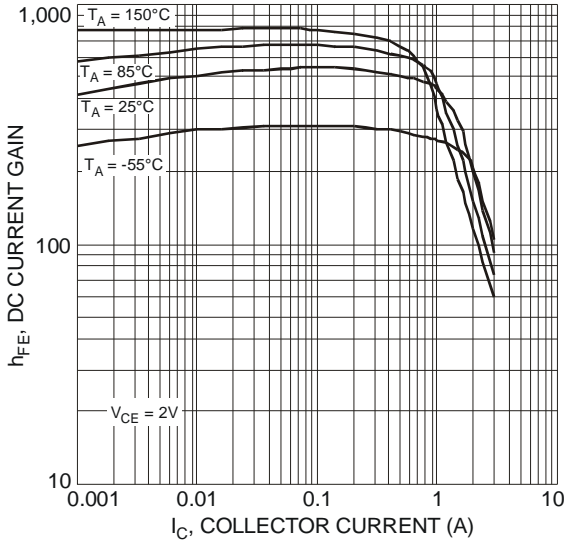


Fig. 3 Typical DC Current Gain vs. Collector Current

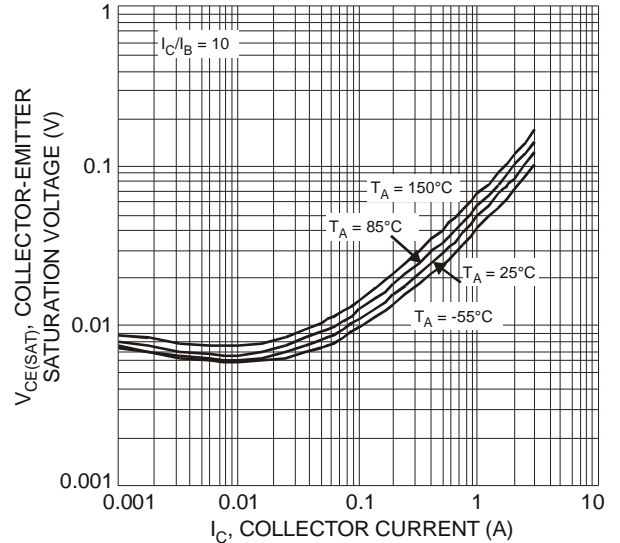


Fig. 4 Typical Collector-Emitter Saturation Voltage vs. Collector Current

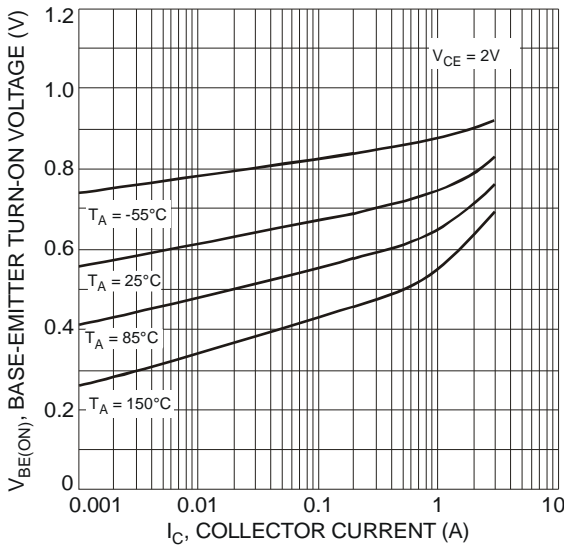


Fig. 5 Typical Base-Emitter Turn-On Voltage vs. Collector Current

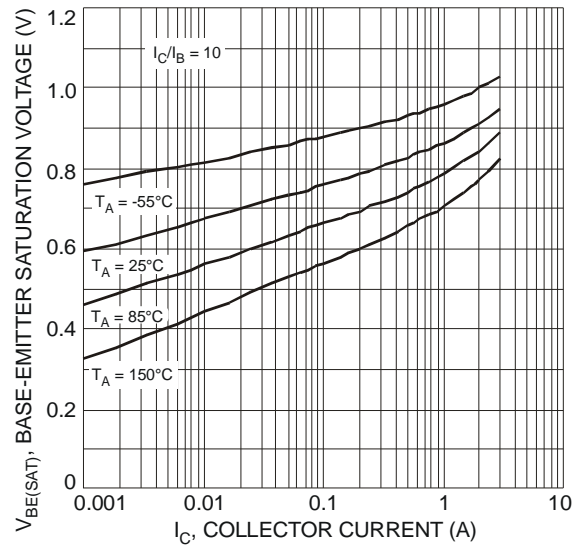


Fig. 6 Typical Base-Emitter Saturation Voltage vs. Collector Current

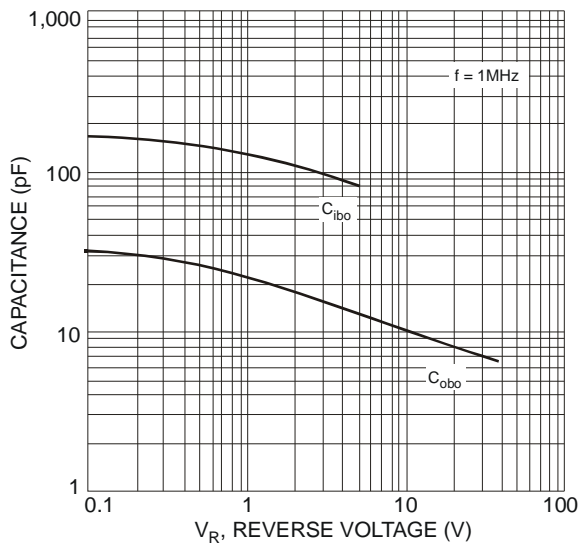


Fig. 7 Typical Capacitance Characteristics

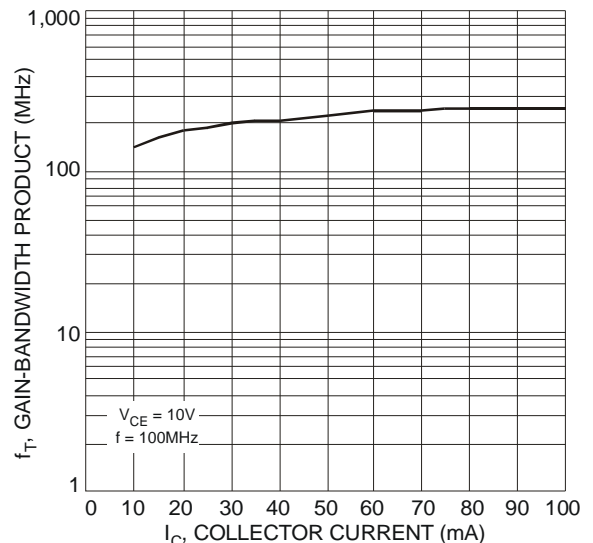


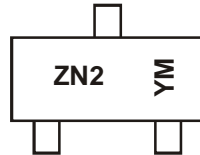
Fig. 8 Typical Gain-Bandwidth Product vs. Collector Current

**Ordering Information** (Note 6)

Part Number	Case	Packaging
DSS4240T-7	SOT-23	3000/Tape & Reel

Notes: 6. For packaging details, go to our website at <http://www.diodes.com/datasheets/ap02007.pdf>.

**Marking Information**



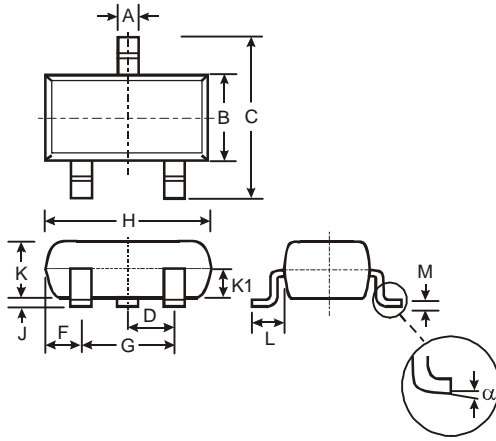
ZN2 = Product Type Marking Code  
 YM = Date Code Marking  
 Y = Year (ex: V = 2008)  
 M = Month (ex: 9 = September)

Date Code Key

Year	2008	2009	2010	2011	2012	2013	2014	2015
Code	V	W	X	Y	Z	A	B	C

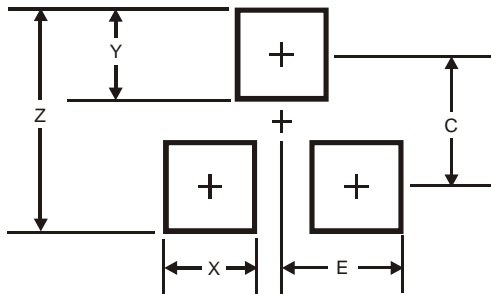
Month	Jan	Feb	Mar	Apr	May	Jun	Jul	Aug	Sep	Oct	Nov	Dec
Code	1	2	3	4	5	6	7	8	9	O	N	D

**Package Outline Dimensions**



SOT-23			
Dim	Min	Max	Typ
A	0.37	0.51	0.40
B	1.20	1.40	1.30
C	2.30	2.50	2.40
D	0.89	1.03	0.915
F	0.45	0.60	0.535
G	1.78	2.05	1.83
H	2.80	3.00	2.90
J	0.013	0.10	0.05
K	0.903	1.10	1.00
K1	-	-	0.400
L	0.45	0.61	0.55
M	0.085	0.18	0.11
$\alpha$	0°	8°	-
All Dimensions in mm			

**Suggested Pad Layout**



Dimensions	Value (in mm)
Z	2.9
X	0.8
Y	0.9
C	2.0
E	1.35

**IMPORTANT NOTICE**

DIODES INCORPORATED MAKES NO WARRANTY OF ANY KIND, EXPRESS OR IMPLIED, WITH REGARDS TO THIS DOCUMENT, INCLUDING, BUT NOT LIMITED TO, THE IMPLIED WARRANTIES OF MERCHANTABILITY AND FITNESS FOR A PARTICULAR PURPOSE (AND THEIR EQUIVALENTS UNDER THE LAWS OF ANY JURISDICTION).

Diodes Incorporated and its subsidiaries reserve the right to make modifications, enhancements, improvements, corrections or other changes without further notice to this document and any product described herein. Diodes Incorporated does not assume any liability arising out of the application or use of this document or any product described herein; neither does Diodes Incorporated convey any license under its patent or trademark rights, nor the rights of others. Any Customer or user of this document or products described herein in such applications shall assume all risks of such use and will agree to hold Diodes Incorporated and all the companies whose products are represented on Diodes Incorporated website, harmless against all damages.

Diodes Incorporated does not warrant or accept any liability whatsoever in respect of any products purchased through unauthorized sales channel. Should Customers purchase or use Diodes Incorporated products for any unintended or unauthorized application, Customers shall indemnify and hold Diodes Incorporated and its representatives harmless against all claims, damages, expenses, and attorney fees arising out of, directly or indirectly, any claim of personal injury or death associated with such unintended or unauthorized application.

Products described herein may be covered by one or more United States, international or foreign patents pending. Product names and markings noted herein may also be covered by one or more United States, international or foreign trademarks.

**LIFE SUPPORT**

Diodes Incorporated products are specifically not authorized for use as critical components in life support devices or systems without the express written approval of the Chief Executive Officer of Diodes Incorporated. As used herein:

A. Life support devices or systems are devices or systems which:

1. are intended to implant into the body, or
2. support or sustain life and whose failure to perform when properly used in accordance with instructions for use provided in the labeling can be reasonably expected to result in significant injury to the user.

B. A critical component is any component in a life support device or system whose failure to perform can be reasonably expected to cause the failure of the life support device or to affect its safety or effectiveness.

Customers represent that they have all necessary expertise in the safety and regulatory ramifications of their life support devices or systems, and acknowledge and agree that they are solely responsible for all legal, regulatory and safety-related requirements concerning their products and any use of Diodes Incorporated products in such safety-critical, life support devices or systems, notwithstanding any devices- or systems-related information or support that may be provided by Diodes Incorporated. Further, Customers must fully indemnify Diodes Incorporated and its representatives against any damages arising out of the use of Diodes Incorporated products in such safety-critical, life support devices or systems.

Copyright © 2009, Diodes Incorporated

**[www.diodes.com](http://www.diodes.com)**