

2N6284 (NPN); 2N6286, 2N6287 (PNP)

Preferred Device

Darlington Complementary Silicon Power Transistors

These packages are designed for general-purpose amplifier and low-frequency switching applications.

Features

- High DC Current Gain @ $I_C = 10 \text{ Adc}$ –
 $h_{FE} = 2400 \text{ (Typ)} - 2N6284$
 $= 4000 \text{ (Typ)} - 2N6287$
- Collector–Emitter Sustaining Voltage –
 $V_{CEO(sus)} = 100 \text{ Vdc (Min)}$
- Monolithic Construction with Built–In Base–Emitter Shunt Resistors
- Pb–Free Packages are Available*

MAXIMUM RATINGS (Note 1)

Rating	Symbol	Value	Unit
Collector–Emitter Voltage 2N6286 2N6284/87	V_{CEO}	80 100	Vdc
Collector–Base Voltage 2N6286 2N6284/87	V_{CB}	80 100	Vdc
Emitter–Base Voltage	V_{EB}	5.0	Vdc
Collector Current – Continuous Peak	I_C	20 40	Adc
Base Current	I_B	0.5	Adc
Total Power Dissipation @ $T_C = 25^\circ\text{C}$ Derate above 25°C	P_D	160 0.915	W W/ $^\circ\text{C}$
Operating and Storage Temperature Range	T_J, T_{stg}	–65 to +200	$^\circ\text{C}$

THERMAL CHARACTERISTICS (Note 1)

Characteristic	Symbol	Max	Unit
Thermal Resistance, Junction–to–Case	$R_{\theta JC}$	1.09	$^\circ\text{C/W}$

Stresses exceeding Maximum Ratings may damage the device. Maximum Ratings are stress ratings only. Functional operation above the Recommended Operating Conditions is not implied. Extended exposure to stresses above the Recommended Operating Conditions may affect device reliability.

1. Indicates JEDEC Registered Data.

*For additional information on our Pb–Free strategy and soldering details, please download the ON Semiconductor Soldering and Mounting Techniques Reference Manual, SOLDERRM/D.



ON Semiconductor®

<http://onsemi.com>

20 AMPERE COMPLEMENTARY SILICON POWER TRANSISTORS 100 VOLTS, 160 WATTS

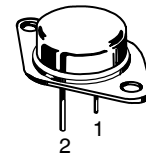
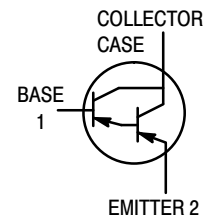

TO–204AA (TO–3)
CASE 1–07
STYLE 1

MARKING DIAGRAM



2N628x = Device Code
 x = 4, 6 or 7
 G = Pb–Free Package
 A = Location Code
 YY = Year
 WW = Work Week
 MEX = Country of Origin

ORDERING INFORMATION

Device	Package	Shipping
2N6284	TO–3	100 Units/Tray
2N6284G	TO–3 (Pb–Free)	100 Units/Tray
2N6286	TO–3	100 Units/Tray
2N6286G	TO–3 (Pb–Free)	100 Units/Tray
2N6287	TO–3	100 Units/Tray
2N6287G	TO–3 (Pb–Free)	100 Units/Tray

2N6284 (NPN); 2N6286, 2N6287 (PNP)

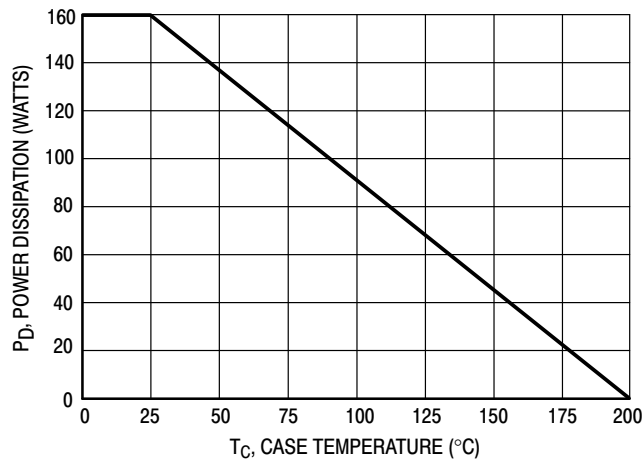

Figure 1. Power Derating

ELECTRICAL CHARACTERISTICS (T_C = 25°C unless otherwise noted) (Note 2)

Characteristic	Symbol	Min	Max	Unit
OFF CHARACTERISTICS				
Collector–Emitter Sustaining Voltage (I _C = 0.1 Adc, I _B = 0)	V _{CEO(sus)}	80	–	Vdc
		100	–	
				2N6286 2N6284, 2N6287
Collector Cutoff Current (V _{CE} = 40 Vdc, I _B = 0)	I _{CEO}	–	1.0	mAdc
(V _{CE} = 50 Vdc, I _B = 0)		–	1.0	
Collector Cutoff Current (V _{CE} = Rated V _{CB} , V _{BE(off)} = 1.5 Vdc)	I _{CEX}	–	0.5	mAdc
(V _{CE} = Rated V _{CB} , V _{BE(off)} = 1.5 Vdc, T _C = 150°C)		–	5.0	
Emitter Cutoff Current (V _{BE} = 5.0 Vdc, I _C = 0)	I _{EBO}	–	2.0	mAdc
ON CHARACTERISTICS (Note 3)				
DC Current Gain (I _C = 10 Adc, V _{CE} = 3.0 Vdc)	h _{FE}	750	18,000	–
(I _C = 20 Adc, V _{CE} = 3.0 Vdc)		100	–	
Collector–Emitter Saturation Voltage (I _C = 10 Adc, I _B = 40 mAdc)	V _{CE(sat)}	–	2.0	Vdc
(I _C = 20 Adc, I _B = 200 mAdc)		–	3.0	
Base–Emitter On Voltage (I _C = 10 Adc, V _{CE} = 3.0 Vdc)	V _{BE(on)}	–	2.8	Vdc
Base–Emitter Saturation Voltage (I _C = 20 Adc, I _B = 200 mAdc)	V _{BE(sat)}	–	4.0	Vdc
DYNAMIC CHARACTERISTICS				
Magnitude of Common Emitter Small–Signal Short–Circuit Forward Current Transfer Ratio (I _C = 10 Adc, V _{CE} = 3.0 Vdc, f = 1.0 MHz)	h _{fe}	4.0	–	MHz
Output Capacitance (V _{CB} = 10 Vdc, I _E = 0, f = 0.1 MHz)	C _{ob}	–	400	pF
		–	600	
				2N6284 2N6286, 2N6287
Small–Signal Current Gain (I _C = 10 Adc, V _{CE} = 3.0 Vdc, f = 1.0 kHz)	h _{fe}	300	–	–

2. Indicates JEDEC Registered Data.

3. Pulse test: Pulse Width = 300 μs, Duty Cycle = 2%

2N6284 (NPN); 2N6286, 2N6287 (PNP)

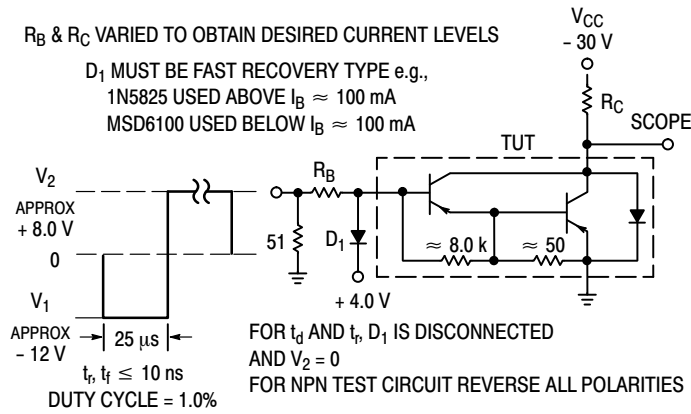

Figure 2. Switching Times Test Circuit

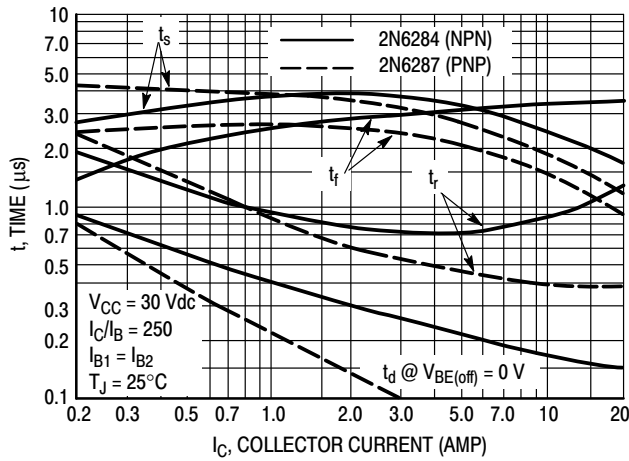

Figure 3. Switching Times

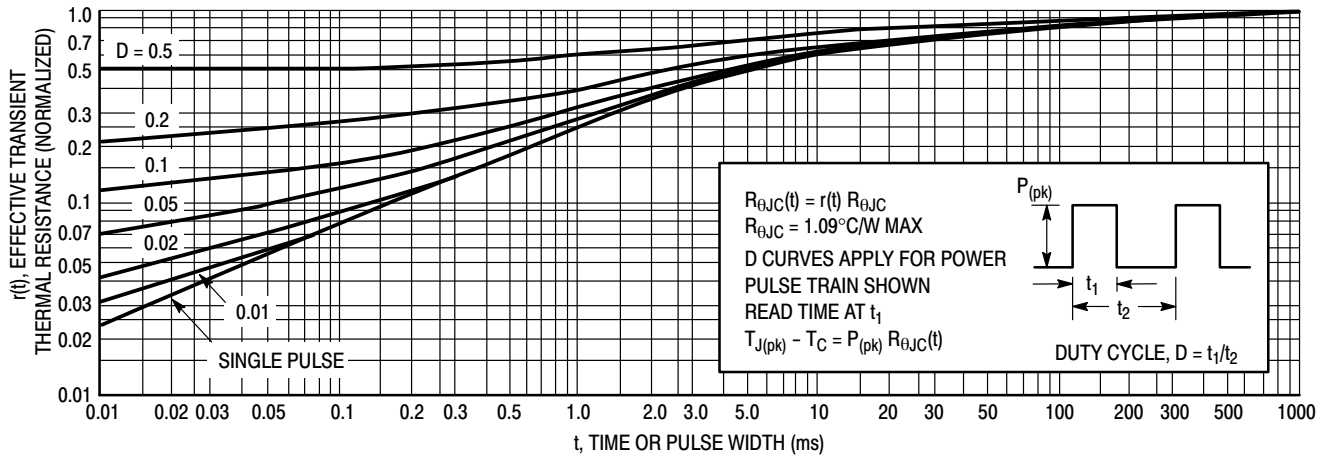

Figure 4. Thermal Response

2N6284 (NPN); 2N6286, 2N6287 (PNP)

ACTIVE-REGION SAFE OPERATING AREA

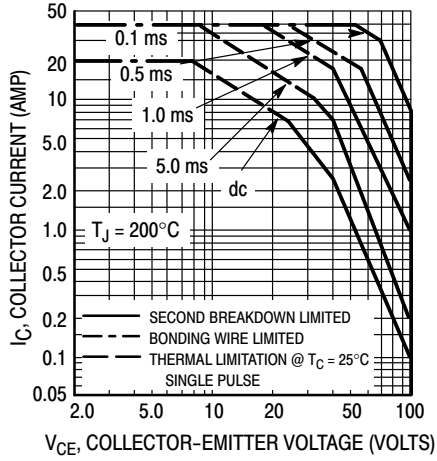

Figure 5. 2N6284, 2N6287

There are two limitations on the power handling ability of a transistor: average junction temperature and second breakdown. Safe operating area curves indicate $I_C - V_{CE}$ limits of the transistor that must be observed for reliable operation; i.e. the transistor must not be subjected to greater dissipation than the curves indicate.

The data of Figure 5 is based on $T_{J(pk)} = 200^\circ\text{C}$; T_C is variable depending on conditions. Second breakdown pulse limits are valid for duty cycles to 10% provided $T_{J(pk)} < 200^\circ\text{C}$. $T_{J(pk)}$ may be calculated from the data in Figure 4. At high case temperatures, thermal limitations will reduce the power that can be handled to values less than the limitations imposed by second breakdown.

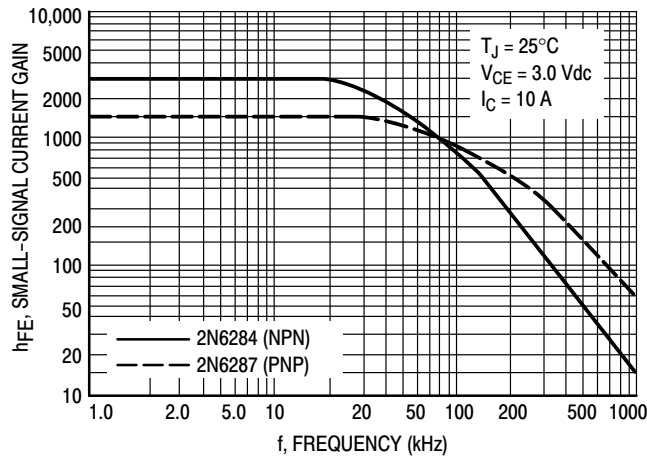

Figure 6. Small-Signal Current Gain

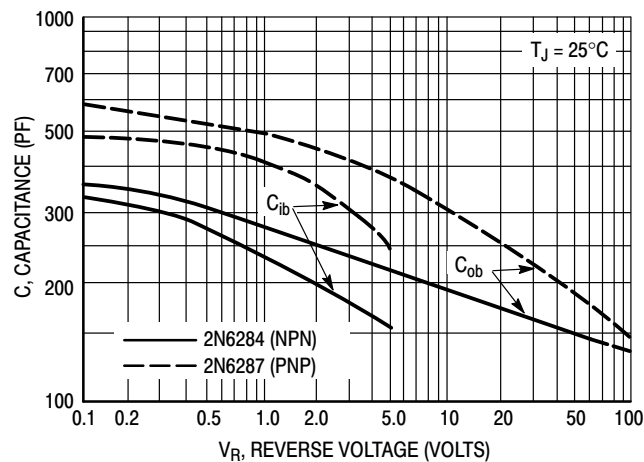

Figure 7. Capacitance

2N6284 (NPN); 2N6286, 2N6287 (PNP)

**NPN
2N6284**

**PNP
2N6287**

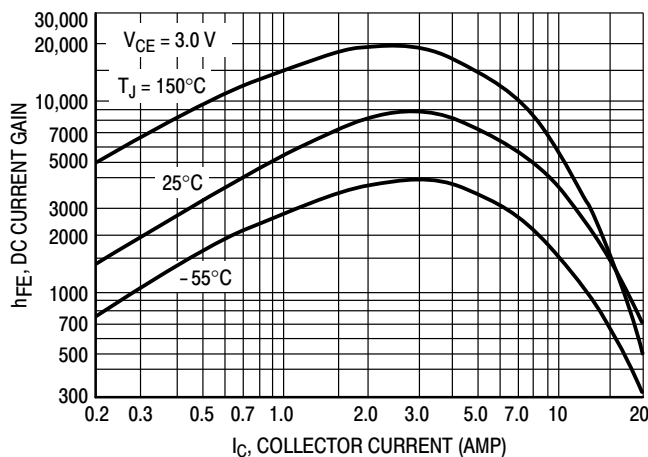
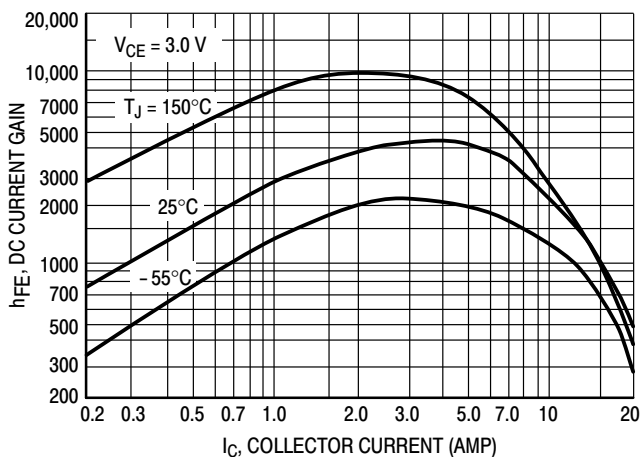

Figure 8. DC Current Gain

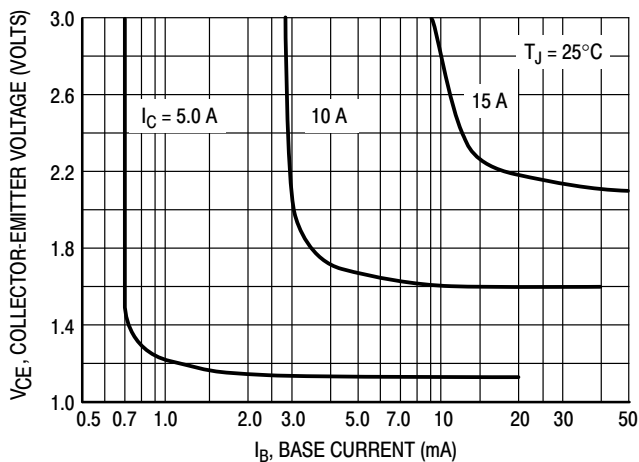
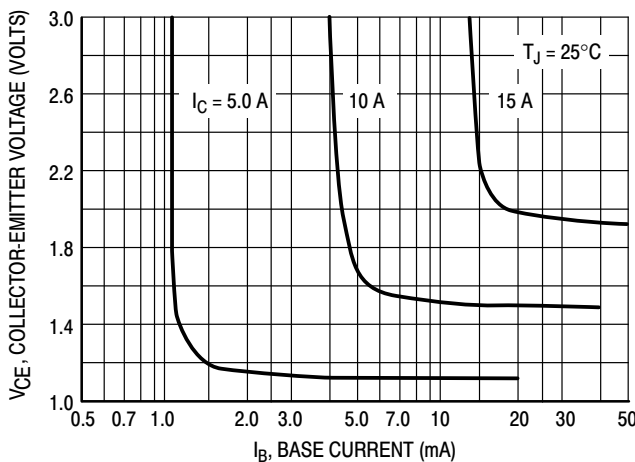

Figure 9. Collector Saturation Region

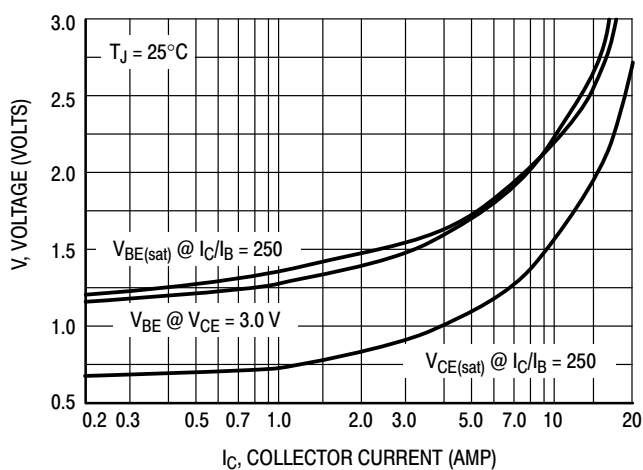
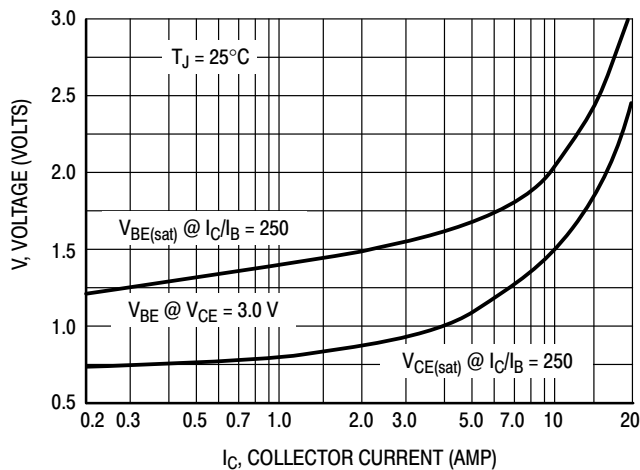

Figure 10. "On" Voltages

2N6284 (NPN); 2N6286, 2N6287 (PNP)

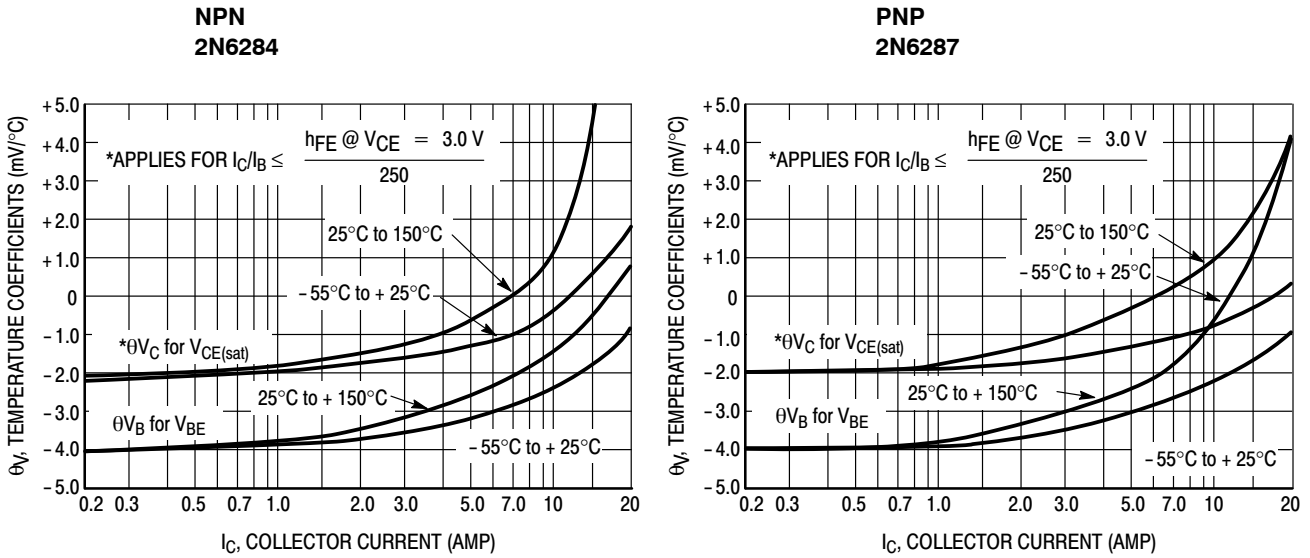

Figure 11. Temperature Coefficients

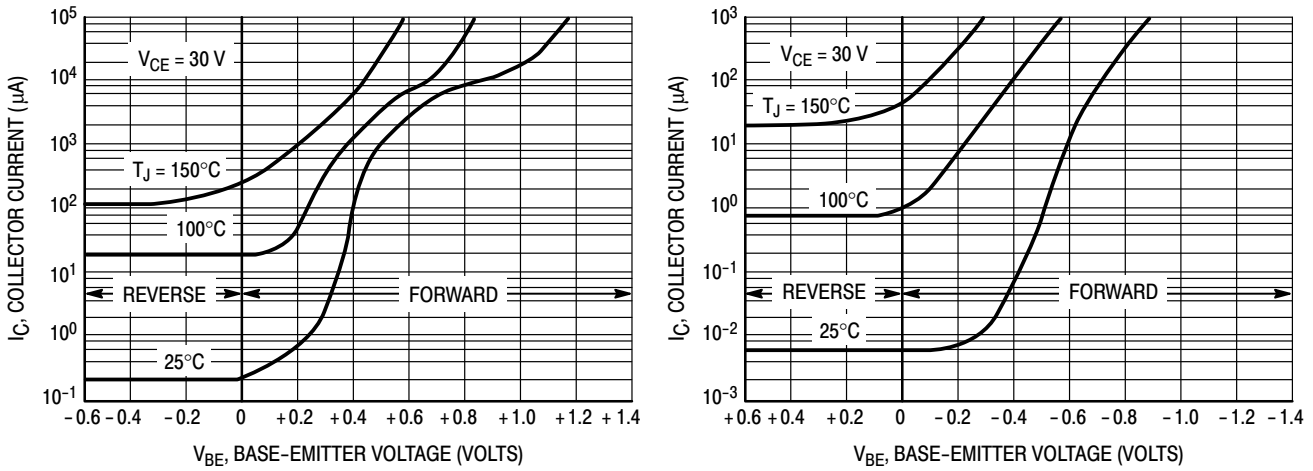

Figure 12. Collector Cut-Off Region

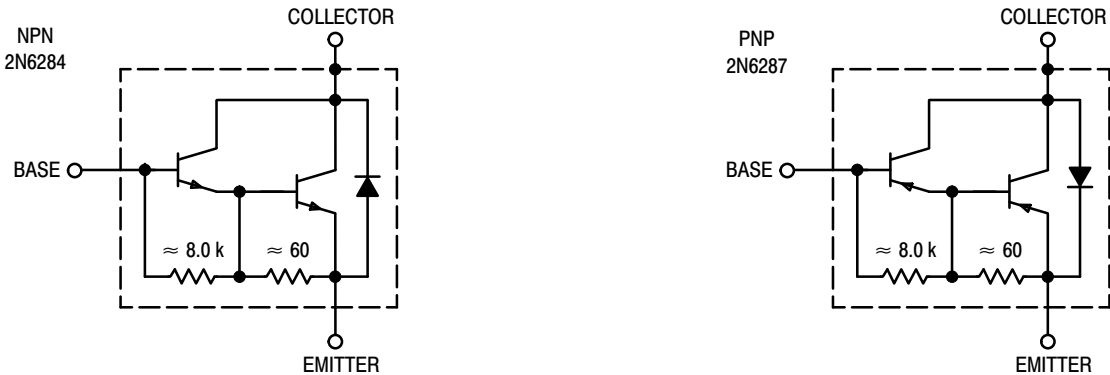
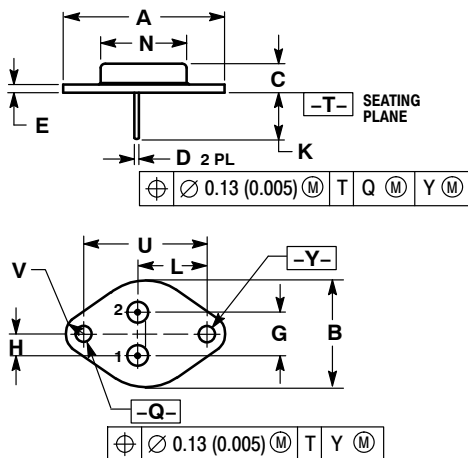

Figure 13. Darlington Schematic

2N6284 (NPN); 2N6286, 2N6287 (PNP)

PACKAGE DIMENSIONS

TO-204 (TO-3)
CASE 1-07
ISSUE Z



- NOTES:
1. DIMENSIONING AND TOLERANCING PER ANSI Y14.5M, 1982.
 2. CONTROLLING DIMENSION: INCH.
 3. ALL RULES AND NOTES ASSOCIATED WITH REFERENCED TO-204AA OUTLINE SHALL APPLY.

DIM	INCHES		MILLIMETERS	
	MIN	MAX	MIN	MAX
A	1.550 REF		39.37 REF	
B	---	1.050	---	26.67
C	0.250	0.335	6.35	8.51
D	0.038	0.043	0.97	1.09
E	0.055	0.070	1.40	1.77
G	0.430 BSC		10.92 BSC	
H	0.215 BSC		5.46 BSC	
K	0.440	0.480	11.18	12.19
L	0.665 BSC		16.89 BSC	
N	---	0.830	---	21.08
Q	0.151	0.165	3.84	4.19
U	1.187 BSC		30.15 BSC	
V	0.131	0.188	3.33	4.77

STYLE 1:
PIN 1. BASE
2. EMITTER
CASE: COLLECTOR

ON Semiconductor and are registered trademarks of Semiconductor Components Industries, LLC (SCILLC). SCILLC reserves the right to make changes without further notice to any products herein. SCILLC makes no warranty, representation or guarantee regarding the suitability of its products for any particular purpose, nor does SCILLC assume any liability arising out of the application or use of any product or circuit, and specifically disclaims any and all liability, including without limitation special, consequential or incidental damages. "Typical" parameters which may be provided in SCILLC data sheets and/or specifications can and do vary in different applications and actual performance may vary over time. All operating parameters, including "Typicals" must be validated for each customer application by customer's technical experts. SCILLC does not convey any license under its patent rights nor the rights of others. SCILLC products are not designed, intended, or authorized for use as components in systems intended for surgical implant into the body, or other applications intended to support or sustain life, or for any other application in which the failure of the SCILLC product could create a situation where personal injury or death may occur. Should Buyer purchase or use SCILLC products for any such unintended or unauthorized application, Buyer shall indemnify and hold SCILLC and its officers, employees, subsidiaries, affiliates, and distributors harmless against all claims, costs, damages, and expenses, and reasonable attorney fees arising out of, directly or indirectly, any claim of personal injury or death associated with such unintended or unauthorized use, even if such claim alleges that SCILLC was negligent regarding the design or manufacture of the part. SCILLC is an Equal Opportunity/Affirmative Action Employer. This literature is subject to all applicable copyright laws and is not for resale in any manner.

PUBLICATION ORDERING INFORMATION

LITERATURE FULFILLMENT:
Literature Distribution Center for ON Semiconductor
P.O. Box 5163, Denver, Colorado 80217 USA
Phone: 303-675-2175 or 800-344-3860 Toll Free USA/Canada
Fax: 303-675-2176 or 800-344-3867 Toll Free USA/Canada
Email: orderlit@onsemi.com

N. American Technical Support: 800-282-9855 Toll Free
USA/Canada
Europe, Middle East and Africa Technical Support:
Phone: 421 33 790 2910
Japan Customer Focus Center
Phone: 81-3-5773-3850

ON Semiconductor Website: www.onsemi.com
Order Literature: <http://www.onsemi.com/orderlit>

For additional information, please contact your local Sales Representative

2N6284/D