

# MJE15034 NPN, MJE15035 PNP

Preferred Device

## Complementary Silicon Plastic Power Transistors

### TO-220, NPN & PNP Devices

Complementary silicon plastic power transistors are designed for use as high-frequency drivers in audio amplifiers.

#### Features

- $h_{FE} = 100$  (Min) @  $I_C = 0.5$  Adc  
= 10 (Min) @  $I_C = 2.0$  Adc
- Collector-Emitter Sustaining Voltage –  
 $V_{CEO(sus)} = 350$  Vdc (Min) – MJE15034, MJE15035
- High Current Gain – Bandwidth Product  
 $f_T = 30$  MHz (Min) @  $I_C = 500$  mA
- TO-220AB Compact Package
- Epoxy meets UL 94 V-0 @ 0.125 in
- ESD Ratings: Machine Model: C  
Human Body Model: 3B
- Pb-Free Packages are Available\*

#### MAXIMUM RATINGS

Rating	Symbol	Value	Unit
Collector-Emitter Voltage	$V_{CEO}$	350	Vdc
Collector-Base Voltage	$V_{CB}$	350	Vdc
Emitter-Base Voltage	$V_{EB}$	5.0	Vdc
Collector Current – Continuous – Peak	$I_C$	4.0 8.0	Adc
Base Current	$I_B$	1.0	Adc
Total Power Dissipation @ $T_C = 25^\circ\text{C}$ Derate above $25^\circ\text{C}$	$P_D$	50 0.40	W W/ $^\circ\text{C}$
Total Power Dissipation @ $T_A = 25^\circ\text{C}$ Derate above $25^\circ\text{C}$	$P_D$	2.0 0.016	W W/ $^\circ\text{C}$
Operating and Storage Junction Temperature Range	$T_J, T_{stg}$	-65 to +150	$^\circ\text{C}$

#### THERMAL CHARACTERISTICS

Characteristic	Symbol	Max	Unit
Thermal Resistance, Junction-to-Case	$R_{\theta JC}$	2.5	$^\circ\text{C}/\text{W}$
Thermal Resistance, Junction-to-Ambient	$R_{\theta JA}$	62.5	$^\circ\text{C}/\text{W}$

Maximum ratings are those values beyond which device damage can occur. Maximum ratings applied to the device are individual stress limit values (not normal operating conditions) and are not valid simultaneously. If these limits are exceeded, device functional operation is not implied, damage may occur and reliability may be affected.

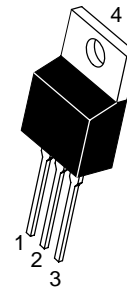
\*For additional information on our Pb-Free strategy and soldering details, please download the ON Semiconductor Soldering and Mounting Techniques Reference Manual, SOLDERRM/D.



ON Semiconductor®

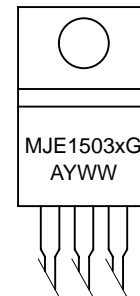
<http://onsemi.com>

### 4.0 AMPERES POWER TRANSISTORS COMPLEMENTARY SILICON 350 VOLTS, 50 WATTS



TO-220AB  
CASE 221A  
STYLE 1

#### MARKING DIAGRAM



MJE1503x = Device Code  
x = 4 or 5  
A = Location Code  
Y = Year  
WW = Work Week  
G = Pb-Free Package

#### ORDERING INFORMATION

Device	Package	Shipping
MJE15034	TO-220AB	50 Units / Rail
MJE15034G	TO-220AB (Pb-Free)	50 Units / Rail
MJE15035	TO-220AB	50 Units / Rail
MJE15035G	TO-220AB (Pb-Free)	50 Units / Rail

Preferred devices are recommended choices for future use and best overall value.

# MJE15034 NPN, MJE15035 PNP

## ELECTRICAL CHARACTERISTICS ( $T_C = 25^\circ\text{C}$ unless otherwise noted)

Characteristic	Symbol	Min	Max	Unit	
<b>OFF CHARACTERISTICS</b>					
Collector-Emitter Sustaining Voltage (Note 1)	$(I_C = 10 \text{ mAdc}, I_B = 0)$	$V_{CEO(sus)}$	350	–	Vdc
Collector Cutoff Current	$(V_{CB} = 350 \text{ Vdc}, I_E = 0)$	$I_{CBO}$	–	10	$\mu\text{Adc}$
Emitter Cutoff Current	$(V_{BE} = 5.0 \text{ Vdc}, I_C = 0)$	$I_{EBO}$	–	10	$\mu\text{Adc}$
<b>ON CHARACTERISTICS (Note 1)</b>					
DC Current Gain	$(I_C = 0.1 \text{ Adc}, V_{CE} = 5.0 \text{ Vdc})$ $(I_C = 0.5 \text{ Adc}, V_{CE} = 5.0 \text{ Vdc})$ $(I_C = 1.0 \text{ Adc}, V_{CE} = 5.0 \text{ Vdc})$ $(I_C = 2.0 \text{ Adc}, V_{CE} = 5.0 \text{ Vdc})$	$h_{FE}$	100 100 50 10	– – – –	–
Collector-Emitter Saturation Voltage	$(I_C = 1.0 \text{ Adc}, I_B = 0.1 \text{ Adc})$	$V_{CE(sat)}$	–	0.5	Vdc
Base-Emitter On Voltage	$(I_C = 1.0 \text{ Adc}, V_{CE} = 5.0 \text{ Vdc})$	$V_{BE(on)}$	–	1.0	Vdc
<b>DYNAMIC CHARACTERISTICS</b>					
Current Gain – Bandwidth Product (Note 2) $(I_C = 500 \text{ mAdc}, V_{CE} = 10 \text{ Vdc}, f_{test} = 1.0 \text{ MHz})$		$f_T$	30	–	MHz

1. Pulse Test: Pulse Width  $\leq 300 \mu\text{s}$ , Duty Cycle  $\leq 2.0\%$ .
2.  $f_T = |h_{fe}| \cdot f_{test}$ .

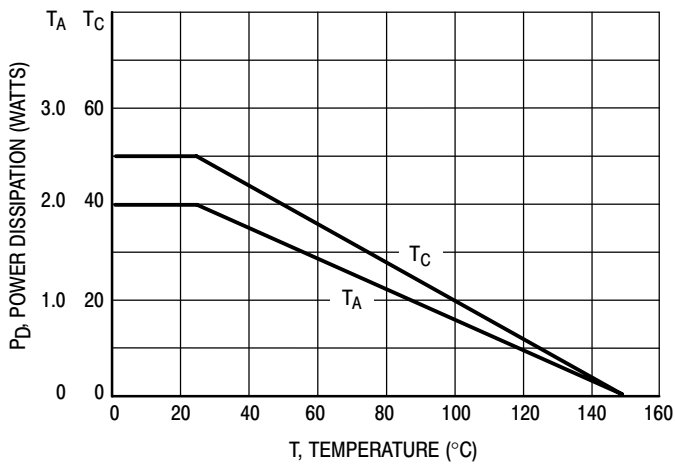


Figure 1. Power Derating

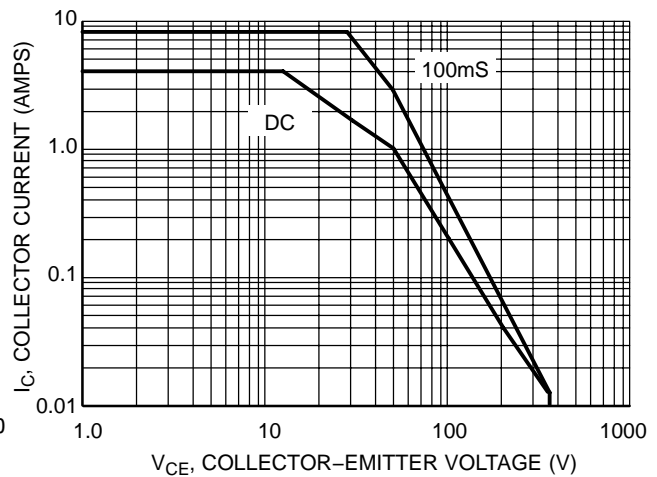


Figure 2. Active Region Safe Operating Area

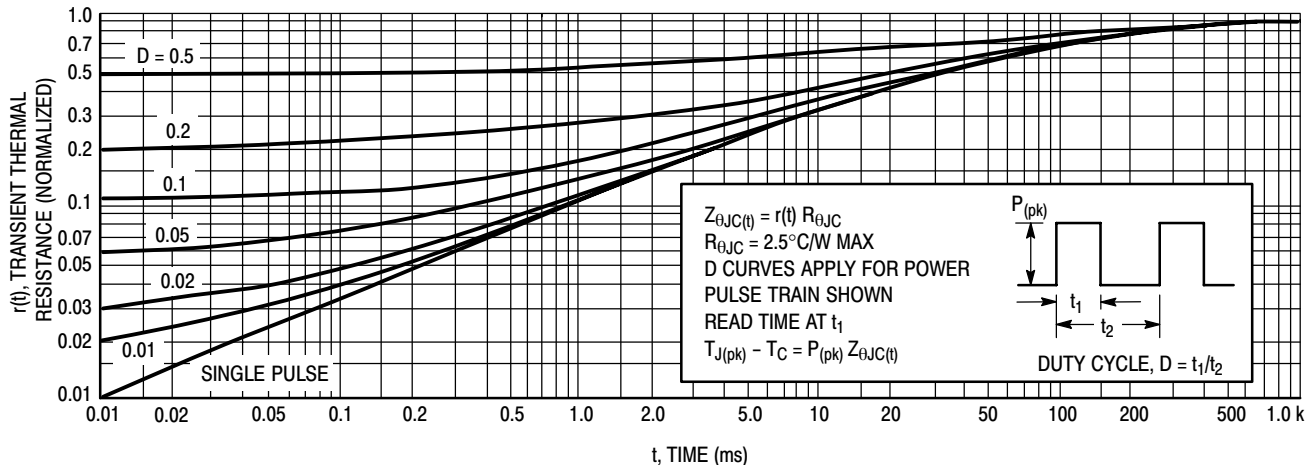
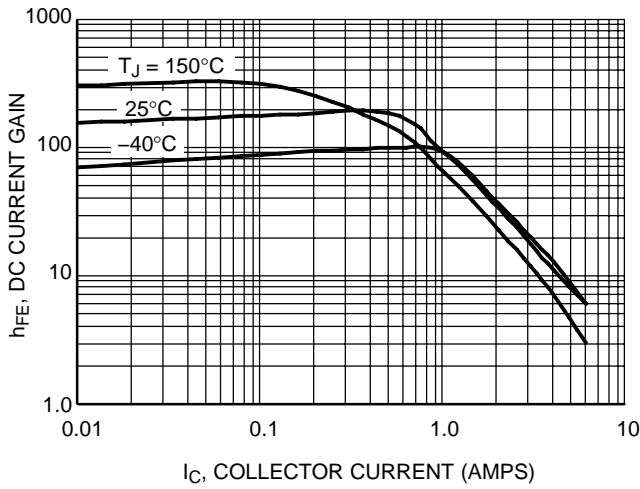
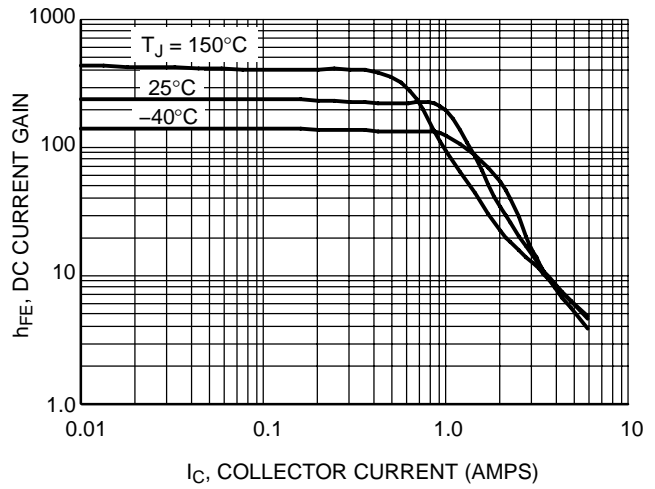


Figure 3. Thermal Response

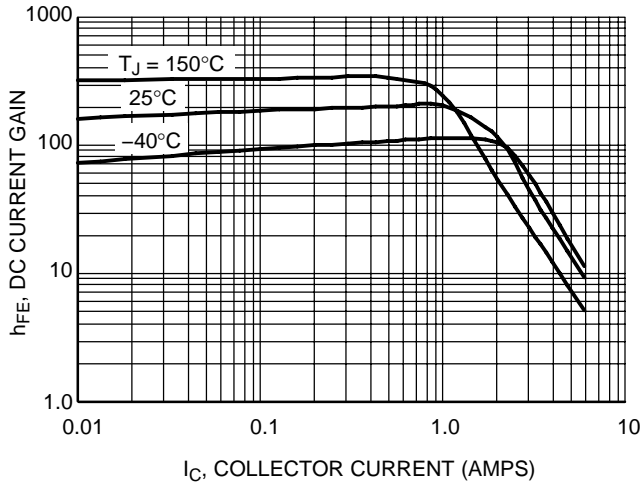
# MJE15034 NPN, MJE15035 PNP



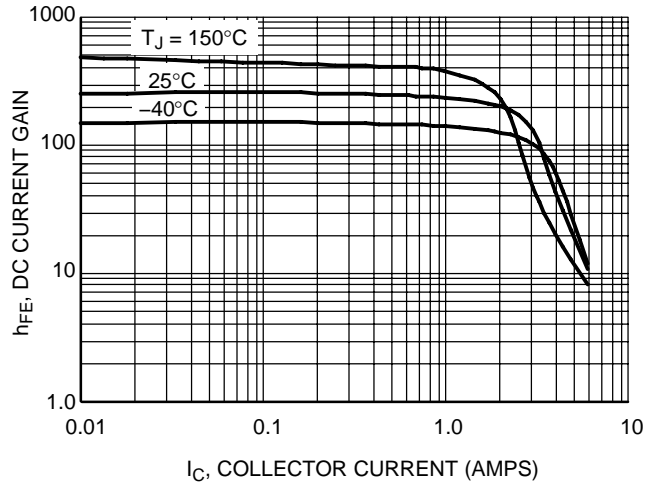
**Figure 4. DC Current Gain,  $V_{CE} = 5.0$  V  
NPN MJE15034**



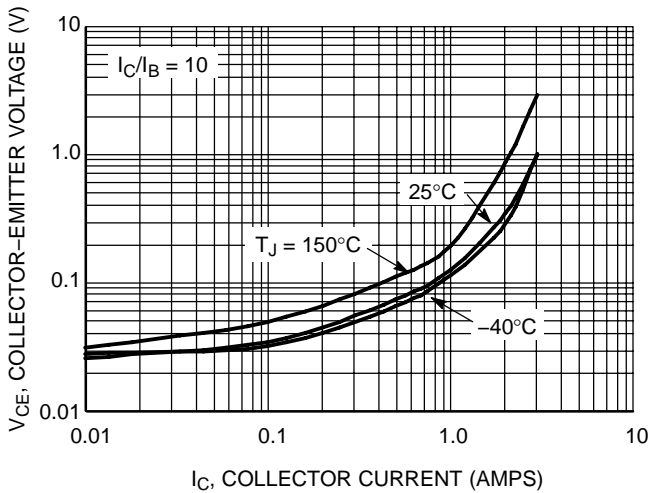
**Figure 5. DC Current Gain,  $V_{CE} = 5.0$  V  
PNP MJE15035**



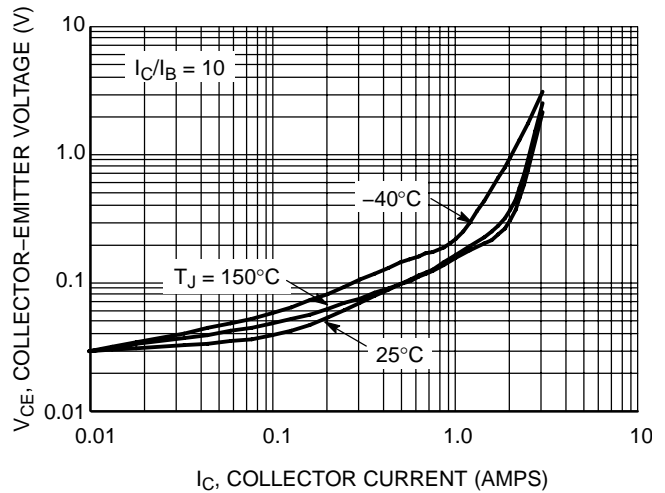
**Figure 6. DC Current Gain,  $V_{CE} = 20$  V  
NPN MJE15034**



**Figure 7. DC Current Gain,  $V_{CE} = 20$  V  
PNP MJE15035**

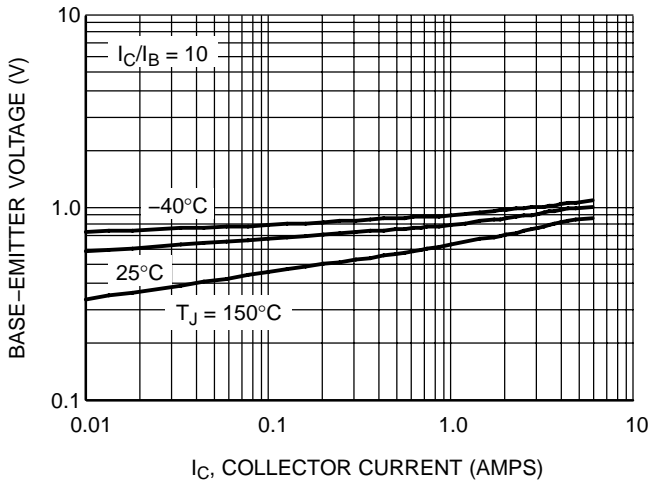


**Figure 8.  $V_{CE(sat)}$   
NPN MJE15034**

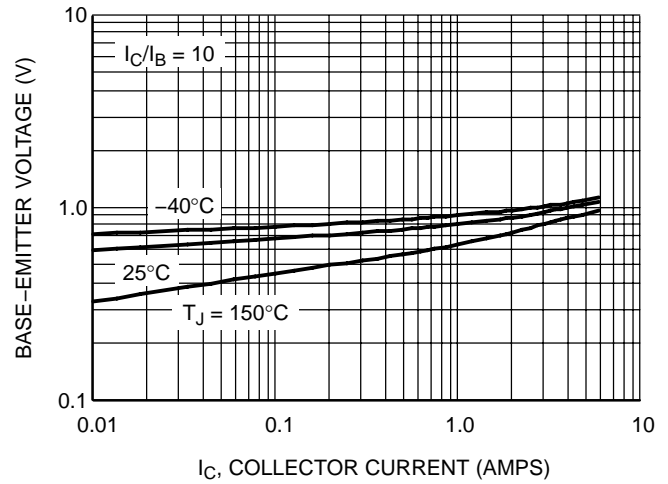


**Figure 9.  $V_{CE(sat)}$   
PNP MJE15035**

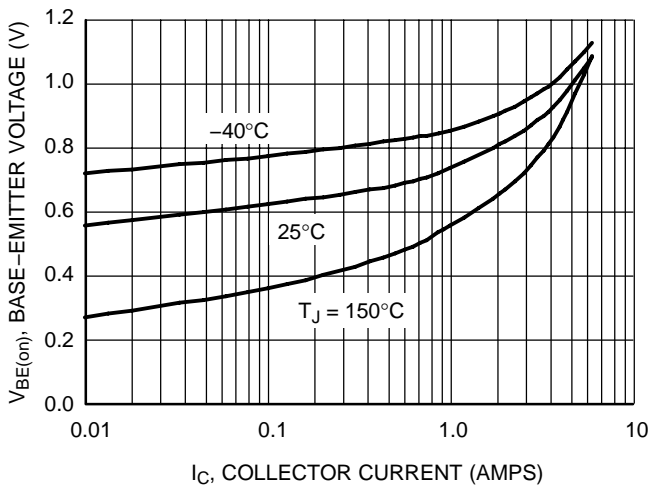
# MJE15034 NPN, MJE15035 PNP



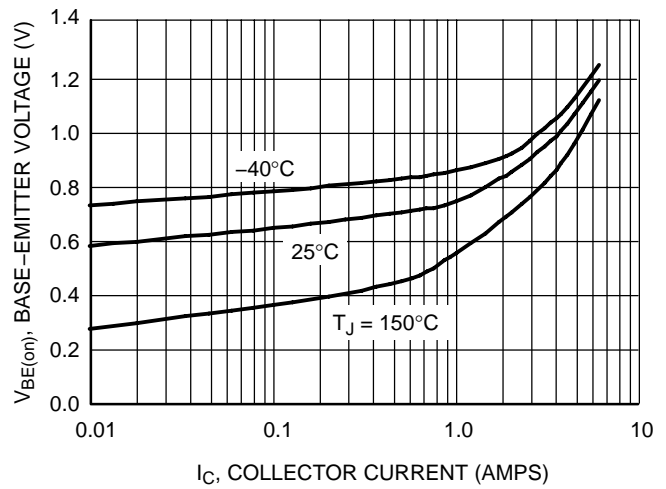
**Figure 10.  $V_{BE(sat)}$   
NPN MJE15034**



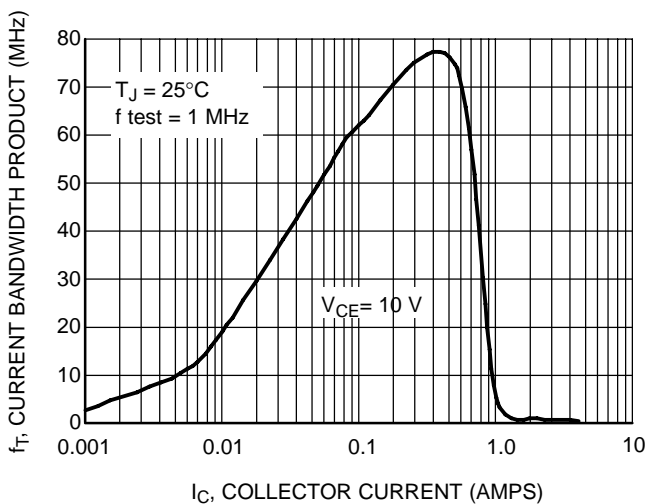
**Figure 11.  $V_{BE(sat)}$   
PNP MJE15035**



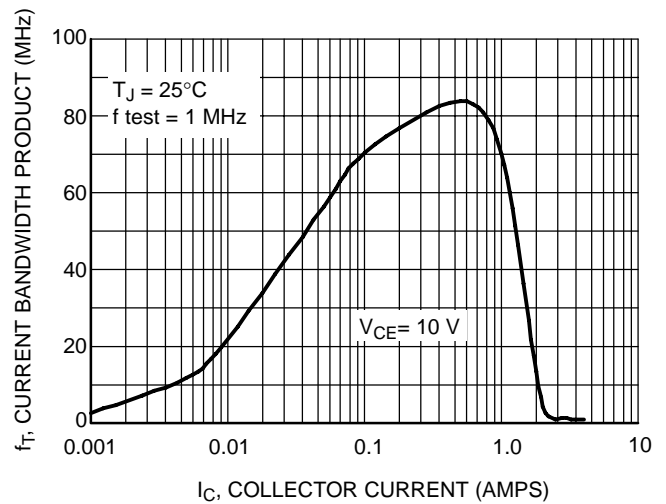
**Figure 12.  $V_{BE(on)}$   
NPN MJE15034**



**Figure 13.  $V_{BE(on)}$   
PNP MJE15035**



**Figure 14. Typical Current Gain Bandwidth Product  
NPN MJE15034**

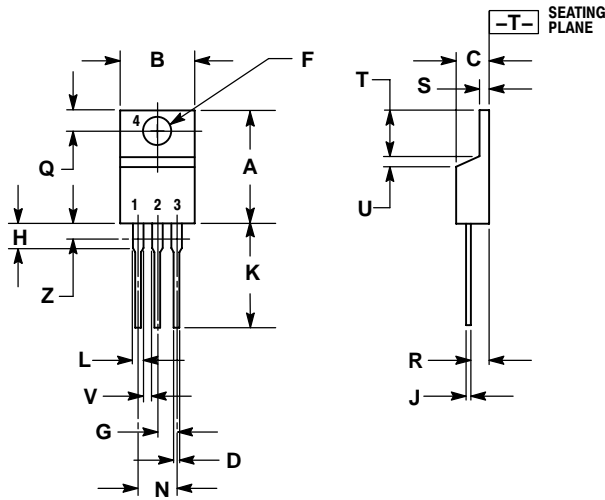


**Figure 15. Typical Current Gain Bandwidth Product  
PNP MJE15035**

# MJE15034 NPN, MJE15035 PNP

## PACKAGE DIMENSIONS

TO-220 THREE-LEAD  
TO-220AB  
CASE 221A-09  
ISSUE AA



- NOTES:
1. DIMENSIONING AND TOLERANCING PER ANSI Y14.5M, 1982.
  2. CONTROLLING DIMENSION: INCH.
  3. DIMENSION Z DEFINES A ZONE WHERE ALL BODY AND LEAD IRREGULARITIES ARE ALLOWED.

DIM	INCHES		MILLIMETERS	
	MIN	MAX	MIN	MAX
A	0.570	0.620	14.48	15.75
B	0.380	0.405	9.66	10.28
C	0.160	0.190	4.07	4.82
D	0.025	0.035	0.64	0.88
F	0.142	0.147	3.61	3.73
G	0.095	0.105	2.42	2.66
H	0.110	0.155	2.80	3.93
J	0.018	0.025	0.46	0.64
K	0.500	0.562	12.70	14.27
L	0.045	0.060	1.15	1.52
N	0.190	0.210	4.83	5.33
Q	0.100	0.120	2.54	3.04
R	0.080	0.110	2.04	2.79
S	0.045	0.055	1.15	1.39
T	0.235	0.255	5.97	6.47
U	0.000	0.050	0.00	1.27
V	0.045	---	1.15	---
Z	---	0.080	---	2.04

STYLE 1:

- PIN 1: BASE  
2. COLLECTOR  
3. EMITTER  
4. COLLECTOR

ON Semiconductor and are registered trademarks of Semiconductor Components Industries, LLC (SCILLC). SCILLC reserves the right to make changes without further notice to any products herein. SCILLC makes no warranty, representation or guarantee regarding the suitability of its products for any particular purpose, nor does SCILLC assume any liability arising out of the application or use of any product or circuit, and specifically disclaims any and all liability, including without limitation special, consequential or incidental damages. "Typical" parameters which may be provided in SCILLC data sheets and/or specifications can and do vary in different applications and actual performance may vary over time. All operating parameters, including "Typicals" must be validated for each customer application by customer's technical experts. SCILLC does not convey any license under its patent rights nor the rights of others. SCILLC products are not designed, intended, or authorized for use as components in systems intended for surgical implant into the body, or other applications intended to support or sustain life, or for any other application in which the failure of the SCILLC product could create a situation where personal injury or death may occur. Should Buyer purchase or use SCILLC products for any such unintended or unauthorized application, Buyer shall indemnify and hold SCILLC and its officers, employees, subsidiaries, affiliates, and distributors harmless against all claims, costs, damages, and expenses, and reasonable attorney fees arising out of, directly or indirectly, any claim of personal injury or death associated with such unintended or unauthorized use, even if such claim alleges that SCILLC was negligent regarding the design or manufacture of the part. SCILLC is an Equal Opportunity/Affirmative Action Employer. This literature is subject to all applicable copyright laws and is not for resale in any manner.

### PUBLICATION ORDERING INFORMATION

**LITERATURE FULFILLMENT:**

Literature Distribution Center for ON Semiconductor  
P.O. Box 61312, Phoenix, Arizona 85082-1312 USA  
Phone: 480-829-7710 or 800-344-3860 Toll Free USA/Canada  
Fax: 480-829-7709 or 800-344-3867 Toll Free USA/Canada  
Email: orderlit@onsemi.com

**N. American Technical Support:** 800-282-9855 Toll Free  
USA/Canada

**Japan:** ON Semiconductor, Japan Customer Focus Center  
2-9-1 Kamimeguro, Meguro-ku, Tokyo, Japan 153-0051  
Phone: 81-3-5773-3850

**ON Semiconductor Website:** <http://onsemi.com>

**Order Literature:** <http://www.onsemi.com/litorder>

For additional information, please contact your local Sales Representative.

**MJE15034/D**