

2N6667, 2N6668

Darlington Silicon Power Transistors

Designed for general-purpose amplifier and low speed switching applications.

- High DC Current Gain -
 $h_{FE} = 3500$ (Typ) @ $I_C = 4.0$ Adc
- Collector-Emitter Sustaining Voltage - @ 200 mAdc
 $V_{CEO(sus)} = 60$ Vdc (Min) - 2N6667
 $= 80$ Vdc (Min) - 2N6668
- Low Collector-Emitter Saturation Voltage -
 $V_{CE(sat)} = 2.0$ Vdc (Max) @ $I_C = 5.0$ Adc
- Monolithic Construction with Built-In Base-Emitter Shunt Resistors
- TO-220AB Compact Package
- Complementary to 2N6387, 2N6388
- Pb-Free Packages are Available*

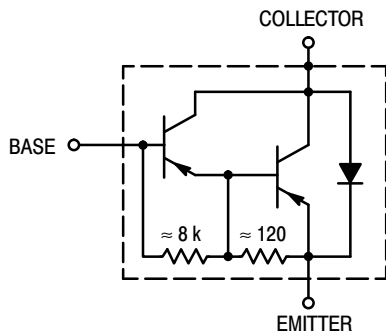

Figure 1. Darlington Schematic



ON Semiconductor®

<http://onsemi.com>

PNP SILICON DARLINGTON POWER TRANSISTORS 10 A, 60-80 V, 65 W

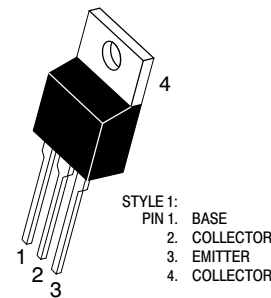

MARKING DIAGRAM

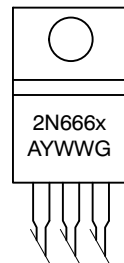

CASE 221A-09
TO-220AB

x = 7 or 8
A = Assembly Location
Y = Year
WW = Work Week
G = Pb-Free Package

ORDERING INFORMATION

Device	Package	Shipping
2N6667	TO-220AB	50 Units/Rail
2N6667G	TO-220AB (Pb-Free)	50 Units/Rail
2N6668	TO-220AB	50 Units/Rail
2N6668G	TO-220AB (Pb-Free)	50 Units/Rail

*For additional information on our Pb-Free strategy and soldering details, please download the ON Semiconductor Soldering and Mounting Techniques Reference Manual, SOLDERRM/D.

2N6667, 2N6668

MAXIMUM RATINGS (Note 1)

Rating	Symbol	2N6667	2N6668	Unit
Collector-Emitter Voltage	V_{CEO}	60	80	Vdc
Collector-Base Voltage	V_{CB}	60	80	Vdc
Emitter-Base Voltage	V_{EB}	5.0		Vdc
Collector Current - Continuous - Peak	I_C	10 15		Adc
Base Current	I_B	250		mAdc
Total Device Dissipation @ $T_C = 25^\circ\text{C}$ Derate above 25°C	P_D	65 0.52		W W/ $^\circ\text{C}$
Total Device Dissipation @ $T_A = 25^\circ\text{C}$ Derate above 25°C	P_D	2.0 0.016		W W/ $^\circ\text{C}$
Operating and Storage Junction Temperature Range	T_J, T_{stg}	—65 to +150		$^\circ\text{C}$

Stresses exceeding Maximum Ratings may damage the device. Maximum Ratings are stress ratings only. Functional operation above the Recommended Operating Conditions is not implied. Extended exposure to stresses above the Recommended Operating Conditions may affect device reliability.

THERMAL CHARACTERISTICS

Characteristic	Symbol	Max	Unit
Thermal Resistance, Junction to Case	$R_{\theta JC}$	1.92	$^\circ\text{C}/\text{W}$
Thermal Resistance, Junction to Ambient	$R_{\theta JA}$	62.5	$^\circ\text{C}/\text{W}$

ELECTRICAL CHARACTERISTICS (Note 1) ($T_C = 25^\circ\text{C}$ unless otherwise noted)

Characteristic	Symbol	Min	Max	Unit
----------------	--------	-----	-----	------

OFF CHARACTERISTICS

Collector-Emitter Sustaining Voltage (Note 2) ($I_C = 200\text{ mAdc}, I_B = 0$)	2N6667 2N6668	$V_{CEO(sus)}$	60 80	- -	Vdc
Collector Cutoff Current ($V_{CE} = 60\text{ Vdc}, I_B = 0$) ($V_{CE} = 80\text{ Vdc}, I_B = 0$)	2N6667 2N6668	I_{CEO}	- -	1.0 1.0	mAdc
Collector Cutoff Current ($V_{CE} = 60\text{ Vdc}, V_{EB(off)} = 1.5\text{ Vdc}$) ($V_{CE} = 80\text{ Vdc}, V_{EB(off)} = 1.5\text{ Vdc}$) ($V_{CE} = 60\text{ Vdc}, V_{EB(off)} = 1.5\text{ Vdc}, T_C = 125^\circ\text{C}$) ($V_{CE} = 80\text{ Vdc}, V_{EB(off)} = 1.5\text{ Vdc}, T_C = 125^\circ\text{C}$)	2N6667 2N6668 2N6667 2N6668	I_{CEX}	- - - -	300 300 3.0 3.0	μAdc mAdc
Emitter Cutoff Current ($V_{BE} = 5.0\text{ Vdc}, I_C = 0$)		I_{EBO}	-	5.0	mAdc

ON CHARACTERISTICS (Note 1)

DC Current Gain ($I_C = 5.0\text{ Adc}, V_{CE} = 3.0\text{ Vdc}$) ($I_C = 10\text{ Adc}, V_{CE} = 3.0\text{ Vdc}$)	h_{FE}	1000 100	20000 -	-
Collector-Emitter Saturation Voltage ($I_C = 5.0\text{ Adc}, I_B = 0.01\text{ Adc}$) ($I_C = 10\text{ Adc}, I_B = 0.1\text{ Adc}$)	$V_{CE(sat)}$	- -	2.0 3.0	Vdc
Base-Emitter Saturation Voltage ($I_C = 5.0\text{ Adc}, I_B = 0.01\text{ Adc}$) ($I_C = 10\text{ Adc}, I_B = 0.1\text{ Adc}$)	$V_{BE(sat)}$	- -	2.8 4.5	Vdc

DYNAMIC CHARACTERISTICS

Current Gain - Bandwidth Product ($I_C = 1.0\text{ Adc}, V_{CE} = 5.0\text{ Vdc}, f_{test} = 1.0\text{ MHz}$)	$ h_{fe} $	20	-	-
Output Capacitance ($V_{CB} = 10\text{ Vdc}, I_E = 0, f = 1.0\text{ MHz}$)	C_{ob}	-	200	pF
Small-Signal Current Gain ($I_C = 1.0\text{ Adc}, V_{CE} = 5.0\text{ Vdc}, f = 1.0\text{ kHz}$)	h_{fe}	1000	-	-

1. Indicates JEDEC Registered Data.
2. Pulse Test: Pulse Width $\leq 300\ \mu\text{s}$, Duty Cycle $\leq 2\%$.

2N6667, 2N6668

R_B & R_C VARIED TO OBTAIN DESIRED CURRENT LEVELS

D_1 , MUST BE FAST RECOVERY TYPES e.g.,

1N5825 USED ABOVE $I_B \approx 100$ mA

MSD6100 USED BELOW $I_B \approx 100$ mA

FOR t_d AND t_f , D_1 IS DISCONNECTED AND $V_2 = 0$

$t_r, t_f \leq 10$ ns

DUTY CYCLE = 1.0%

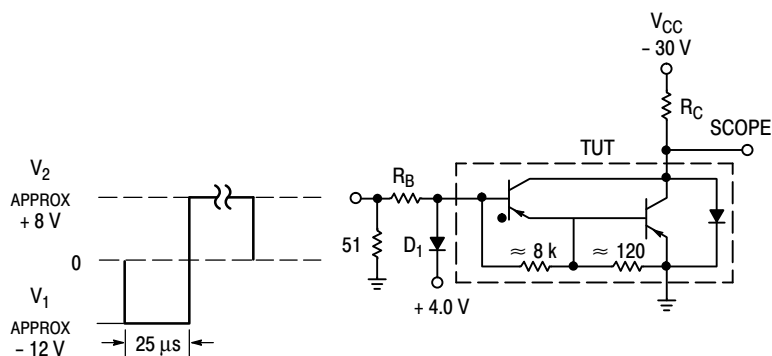

Figure 2. Switching Times Test Circuit

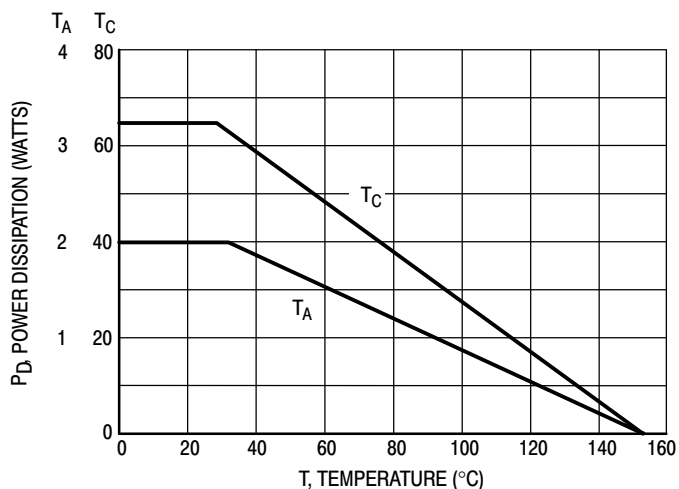

Figure 3. Power Derating

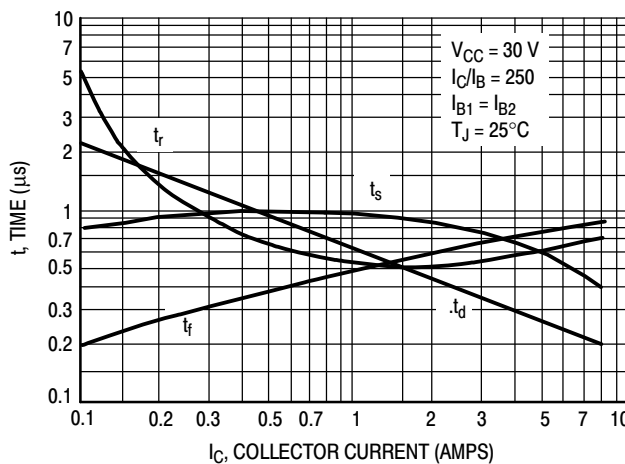

Figure 4. Typical Switching Times

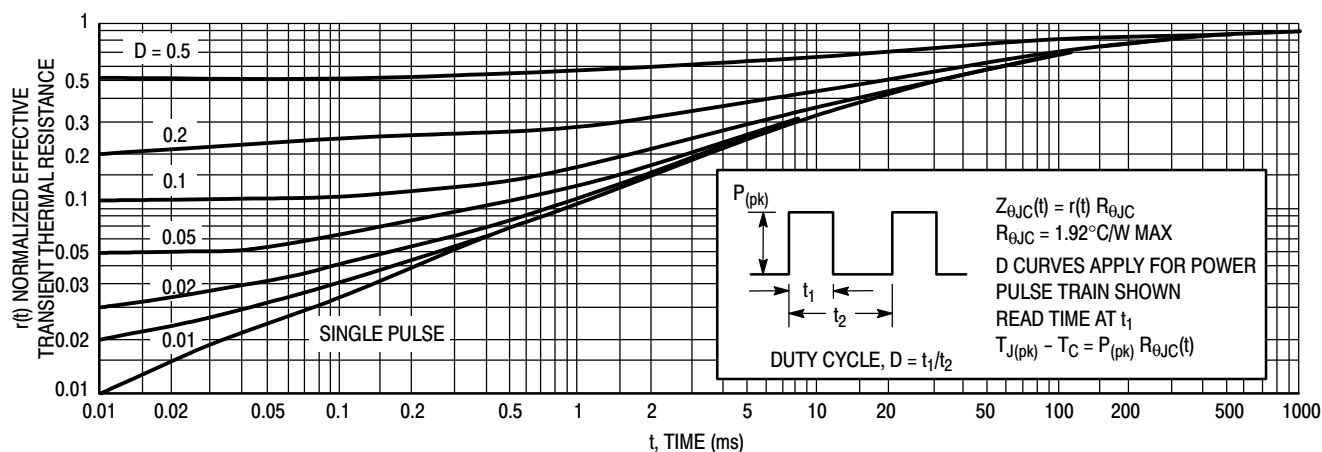

Figure 5. Thermal Response

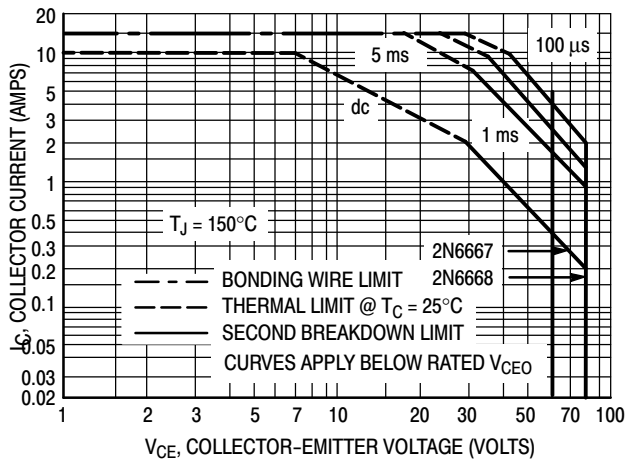

Figure 6. Maximum Safe Operating Area

There are two limitations on the power handling ability of a transistor: average junction temperature and second breakdown. Safe operating area curves indicate $I_C - V_{CE}$ limits of the transistor that must be observed for reliable operation; i.e., the transistor must not be subjected to greater dissipation than the curves indicate.

The data of Figure 6 is based on $T_{J(pk)} = 150^\circ\text{C}$; T_C is variable depending on conditions. Second breakdown pulse limits are valid for duty cycles to 10% provided $T_{J(pk)} < 150^\circ\text{C}$. $T_{J(pk)}$ may be calculated from the data in Figure 5. At high case temperatures, thermal limitations will reduce the power that can be handled to values less than the limitations imposed by second breakdown.

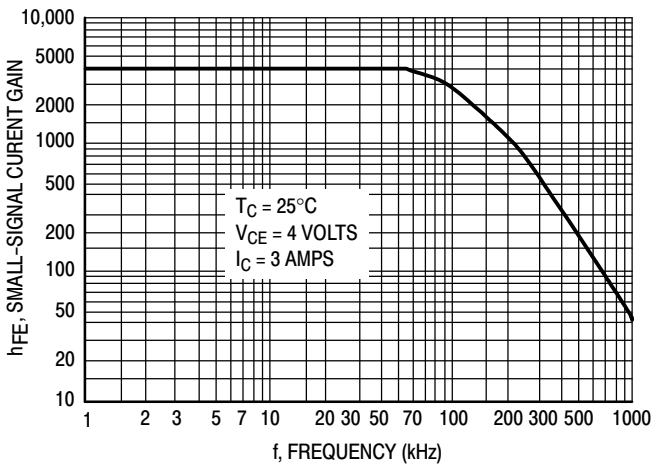

Figure 7. Typical Small-Signal Current Gain

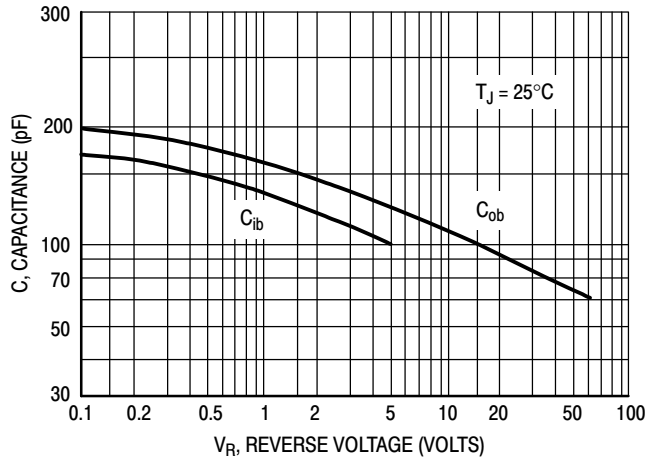

Figure 8. Typical Capacitance

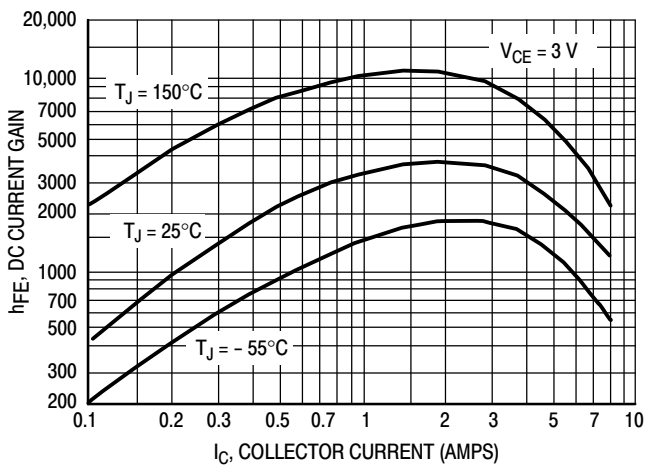

Figure 9. Typical DC Current Gain

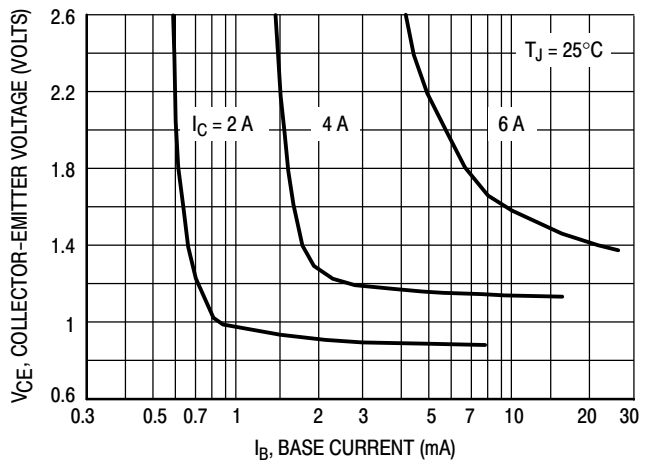

Figure 10. Typical Collector Saturation Region

2N6667, 2N6668

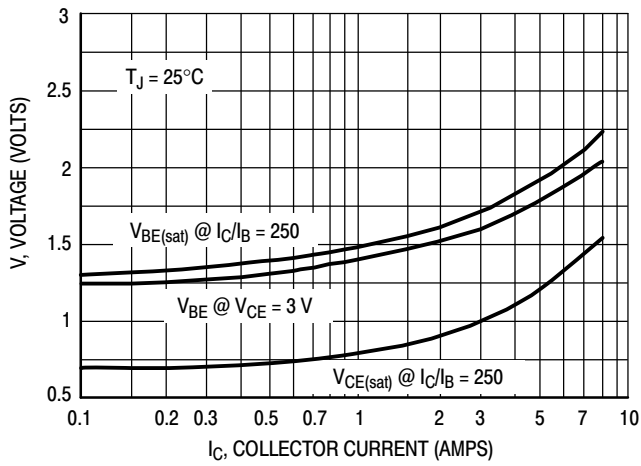

Figure 11. Typical "On" Voltages

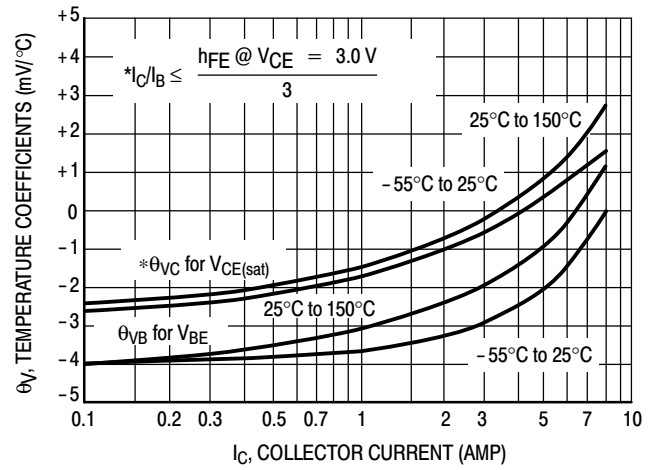

Figure 12. Typical Temperature Coefficients

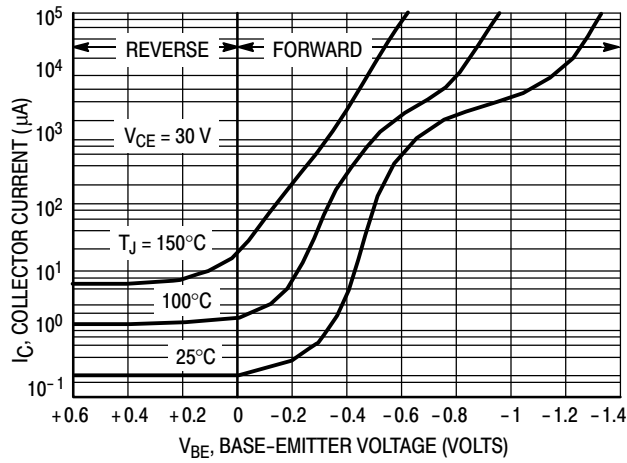
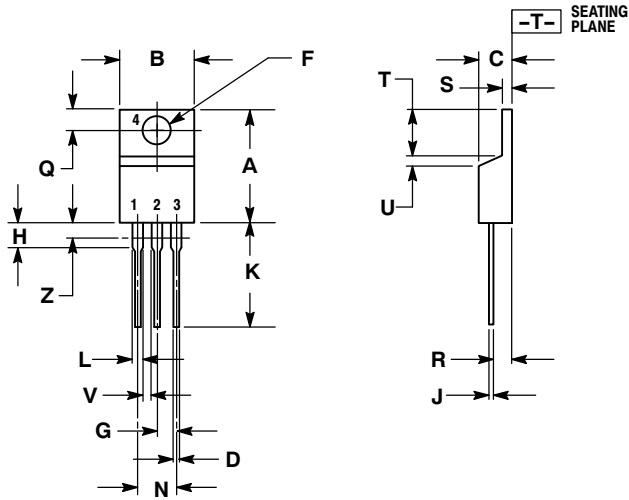

Figure 13. Typical Collector Cut-Off Region

2N6667, 2N6668

PACKAGE DIMENSIONS

TO-220 CASE 221A-09 ISSUE AE



NOTES:

1. DIMENSIONING AND TOLERANCING PER ANSI Y14.5M, 1982.
2. CONTROLLING DIMENSION: INCH.
3. DIMENSION Z DEFINES A ZONE WHERE ALL BODY AND LEAD IRREGULARITIES ARE ALLOWED.

DIM	INCHES		MILLIMETERS	
	MIN	MAX	MIN	MAX
A	0.570	0.620	14.48	15.75
B	0.380	0.405	9.66	10.28
C	0.160	0.190	4.07	4.82
D	0.025	0.035	0.64	0.88
F	0.142	0.161	3.61	4.09
G	0.095	0.105	2.42	2.66
H	0.110	0.155	2.80	3.93
J	0.014	0.025	0.36	0.64
K	0.500	0.562	12.70	14.27
L	0.045	0.060	1.15	1.52
N	0.190	0.210	4.83	5.33
Q	0.100	0.120	2.54	3.04
R	0.080	0.110	2.04	2.79
S	0.045	0.055	1.15	1.39
T	0.235	0.255	5.97	6.47
U	0.000	0.050	0.00	1.27
V	0.045	---	1.15	---
Z	---	0.080	---	2.04

ON Semiconductor and are registered trademarks of Semiconductor Components Industries, LLC (SCILLC). SCILLC reserves the right to make changes without further notice to any products herein. SCILLC makes no warranty, representation or guarantee regarding the suitability of its products for any particular purpose, nor does SCILLC assume any liability arising out of the application or use of any product or circuit, and specifically disclaims any and all liability, including without limitation special, consequential or incidental damages. "Typical" parameters which may be provided in SCILLC data sheets and/or specifications can and do vary in different applications and actual performance may vary over time. All operating parameters, including "Typicals" must be validated for each customer application by customer's technical experts. SCILLC does not convey any license under its patent rights nor the rights of others. SCILLC products are not designed, intended, or authorized for use as components in systems intended for surgical implant into the body, or other applications intended to support or sustain life, or for any other application in which the failure of the SCILLC product could create a situation where personal injury or death may occur. Should Buyer purchase or use SCILLC products for any such unintended or unauthorized application, Buyer shall indemnify and hold SCILLC and its officers, employees, subsidiaries, affiliates, and distributors harmless against all claims, costs, damages, and expenses, and reasonable attorney fees arising out of, directly or indirectly, any claim of personal injury or death associated with such unintended or unauthorized use, even if such claim alleges that SCILLC was negligent regarding the design or manufacture of the part. SCILLC is an Equal Opportunity/Affirmative Action Employer. This literature is subject to all applicable copyright laws and is not for resale in any manner.

PUBLICATION ORDERING INFORMATION

LITERATURE FULFILLMENT:

Literature Distribution Center for ON Semiconductor
P.O. Box 61312, Phoenix, Arizona 85082-1312 USA
Phone: 480-829-7710 or 800-344-3860 Toll Free USA/Canada
Fax: 480-829-7709 or 800-344-3867 Toll Free USA/Canada
Email: orderlit@onsemi.com

N. American Technical Support: 800-282-9855 Toll Free
USA/Canada

Japan: ON Semiconductor, Japan Customer Focus Center
2-9-1 Kamimeguro, Meguro-ku, Tokyo, Japan 153-0051
Phone: 81-3-5773-3850

ON Semiconductor Website: <http://onsemi.com>

Order Literature: <http://www.onsemi.com/litorder>

For additional information, please contact your local Sales Representative.

2N6667/D