

# TIP100, TIP101, TIP102 (NPN); TIP105, TIP106, TIP107 (PNP)

TIP101, TIP102, TIP106 and TIP107 are Preferred Devices

## Plastic Medium-Power Complementary Silicon Transistors

Designed for general-purpose amplifier and low-speed switching applications.

### Features

- High DC Current Gain -  
 $h_{FE} = 2500$  (Typ) @  $I_C$   
 $= 4.0$  Adc
- Collector-Emitter Sustaining Voltage - @ 30 mAdc  
 $V_{CEO(sus)} = 60$  Vdc (Min) - TIP100, TIP105  
 $= 80$  Vdc (Min) - TIP101, TIP106  
 $= 100$  Vdc (Min) - TIP102, TIP107
- Low Collector-Emitter Saturation Voltage -  
 $V_{CE(sat)} = 2.0$  Vdc (Max) @  $I_C$   
 $= 3.0$  Adc  
 $= 2.5$  Vdc (Max) @  $I_C = 8.0$  Adc
- Monolithic Construction with Built-in Base-Emitter Shunt Resistors
- Pb-Free Packages are Available\*



ON Semiconductor®

<http://onsemi.com>

**DARLINGTON 8 AMPERE  
COMPLEMENTARY SILICON  
POWER TRANSISTORS  
60-80-100 VOLTS, 80 WATTS**

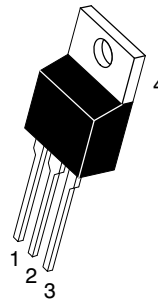

MARKING  
DIAGRAM



TO-220AB  
CASE 221A  
STYLE 1

TIP10x = Device Code  
x = 0, 1, 2, 5, 6, or 7  
A = Assembly Location  
Y = Year  
WW = Work Week  
G = Pb-Free Package

### ORDERING INFORMATION

See detailed ordering and shipping information in the package dimensions section on page 2 of this data sheet.

Preferred devices are recommended choices for future use and best overall value.

\*For additional information on our Pb-Free strategy and soldering details, please download the ON Semiconductor Soldering and Mounting Techniques Reference Manual, SOLDERRM/D.

# TIP100, TIP101, TIP102 (NPN); TIP105, TIP106, TIP107 (PNP)

## MAXIMUM RATINGS

Rating	Symbol	TIP100, TIP105	TIP101, TIP106	TIP102, TIP107	Unit
Collector - Emitter Voltage	$V_{CEO}$	60	80	100	Vdc
Collector - Base Voltage	$V_{CB}$	60	80	100	Vdc
Emitter - Base Voltage	$V_{EB}$	5.0			Vdc
Collector Current - Continuous - Peak	$I_C$	8.0 15			Adc
Base Current	$I_B$	1.0			Adc
Total Power Dissipation @ $T_C = 25^\circ\text{C}$ Derate above $25^\circ\text{C}$	$P_D$	80 0.64			W W/ $^\circ\text{C}$
Unclamped Inductive Load Energy (1)	E	30			mJ
Total Power Dissipation @ $T_A = 25^\circ\text{C}$ Derate above $25^\circ\text{C}$	$P_D$	2.0 0.016			W W/ $^\circ\text{C}$
Operating and Storage Junction Temperature Range	$T_J, T_{stg}$	-65 to +150			$^\circ\text{C}$

## THERMAL CHARACTERISTICS

Characteristic	Symbol	Max	Unit
Thermal Resistance, Junction-to-Case	$R_{\theta JC}$	1.56	$^\circ\text{C/W}$
Thermal Resistance, Junction-to-Ambient	$R_{\theta JA}$	62.5	$^\circ\text{C/W}$

Stresses exceeding Maximum Ratings may damage the device. Maximum Ratings are stress ratings only. Functional operation above the Recommended Operating Conditions is not implied. Extended exposure to stresses above the Recommended Operating Conditions may affect device reliability.

1.  $I_C = 1.1\text{ A}$ ,  $L = 50\text{ mH}$ , P.R.F. = 10 Hz,  $V_{CC} = 20\text{ V}$ ,  $R_{BE} = 100\ \Omega$

## ORDERING INFORMATION

Device	Package	Shipping
TIP100	TO-220	50 Units / Rail
TIP100G	TO-220 (Pb-Free)	50 Units / Rail
TIP101	TO-220	50 Units / Rail
TIP101G	TO-220 (Pb-Free)	50 Units / Rail
TIP102	TO-220	50 Units / Rail
TIP102G	TO-220 (Pb-Free)	50 Units / Rail
TIP105	TO-220	50 Units / Rail
TIP105G	TO-220 (Pb-Free)	50 Units / Rail
TIP106	TO-220	50 Units / Rail
TIP106G	TO-220 (Pb-Free)	50 Units / Rail
TIP107	TO-220	50 Units / Rail
TIP107G	TO-220 (Pb-Free)	50 Units / Rail

# TIP100, TIP101, TIP102 (NPN); TIP105, TIP106, TIP107 (PNP)

## ELECTRICAL CHARACTERISTICS ( $T_C = 25^\circ\text{C}$ unless otherwise noted)

Characteristic	Symbol	Min	Max	Unit	
<b>OFF CHARACTERISTICS</b>					
Collector-Emitter Sustaining Voltage (1) ( $I_C = 30\text{ mA}$ , $I_B = 0$ )	TIP100, TIP105 TIP101, TIP106 TIP102, TIP107	$V_{CE(sus)}$	60 80 100	- - -	Vdc
Collector Cutoff Current ( $V_{CE} = 30\text{ Vdc}$ , $I_B = 0$ ) ( $V_{CE} = 40\text{ Vdc}$ , $I_B = 0$ ) ( $V_{CE} = 50\text{ Vdc}$ , $I_B = 0$ )	TIP100, TIP105 TIP101, TIP106 TIP102, TIP107	$I_{CEO}$	- - -	50 50 50	$\mu\text{A}$
Collector Cutoff Current ( $V_{CB} = 60\text{ Vdc}$ , $I_E = 0$ ) ( $V_{CB} = 80\text{ Vdc}$ , $I_E = 0$ ) ( $V_{CB} = 100\text{ Vdc}$ , $I_E = 0$ )	TIP100, TIP105 TIP101, TIP106 TIP102, TIP107	$I_{CBO}$	- - -	50 50 50	$\mu\text{A}$
Emitter Cutoff Current ( $V_{BE} = 5.0\text{ Vdc}$ , $I_C = 0$ )		$I_{EBO}$	-	8.0	mA
<b>ON CHARACTERISTICS (1)</b>					
DC Current Gain ( $I_C = 3.0\text{ A}$ , $V_{CE} = 4.0\text{ Vdc}$ ) ( $I_C = 8.0\text{ A}$ , $V_{CE} = 4.0\text{ Vdc}$ )		$h_{FE}$	1000 200	20,000 -	-
Collector-Emitter Saturation Voltage ( $I_C = 3.0\text{ A}$ , $I_B = 6.0\text{ mA}$ ) ( $I_C = 8.0\text{ A}$ , $I_B = 80\text{ mA}$ )		$V_{CE(sat)}$	- -	2.0 2.5	Vdc
Base-Emitter On Voltage ( $I_C = 8.0\text{ A}$ , $V_{CE} = 4.0\text{ Vdc}$ )		$V_{BE(on)}$	-	2.8	Vdc
<b>DYNAMIC CHARACTERISTICS</b>					
Small-Signal Current Gain ( $I_C = 3.0\text{ A}$ , $V_{CE} = 4.0\text{ Vdc}$ , $f = 1.0\text{ MHz}$ )		$h_{fe}$	4.0	-	-
Output Capacitance ( $V_{CB} = 10\text{ Vdc}$ , $I_E = 0$ , $f = 0.1\text{ MHz}$ )	TIP105, TIP106, TIP107 TIP100, TIP101, TIP102	$C_{ob}$	- -	300 200	pF

2. Pulse Test: Pulse Width  $\leq 300\ \mu\text{s}$ , Duty Cycle  $\leq 2\%$ .

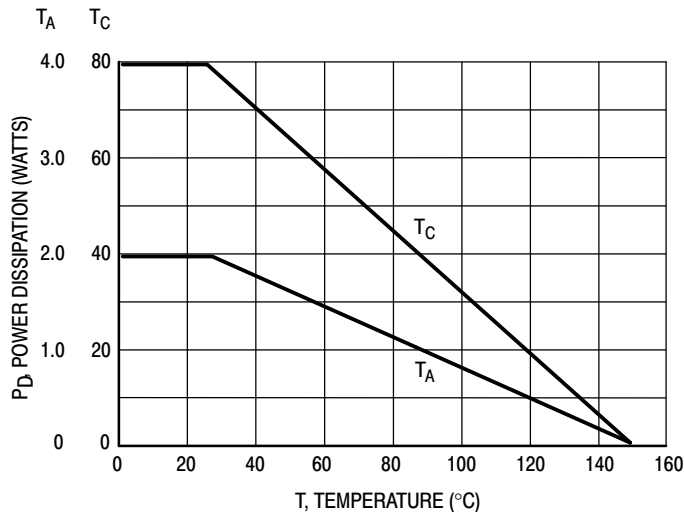

Figure 1. Power Derating

# TIP100, TIP101, TIP102 (NPN); TIP105, TIP106, TIP107 (PNP)

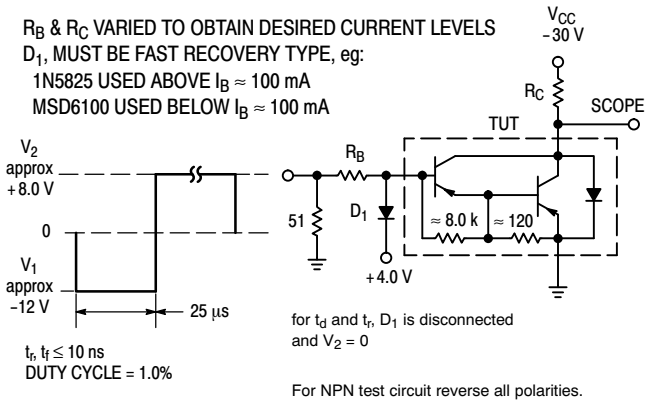

Figure 2. Switching Times Test Circuit

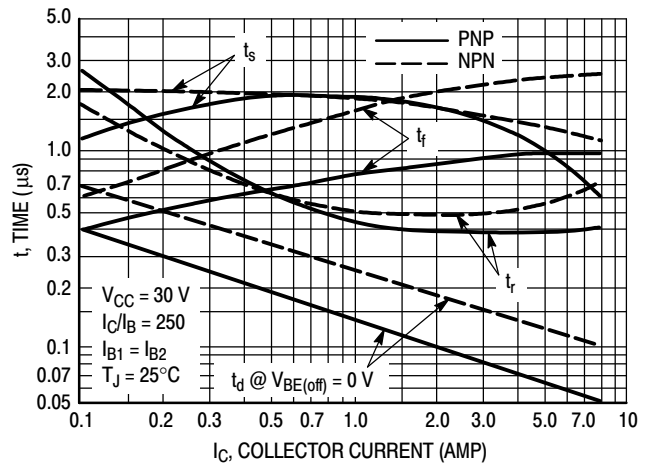

Figure 3. Switching Times

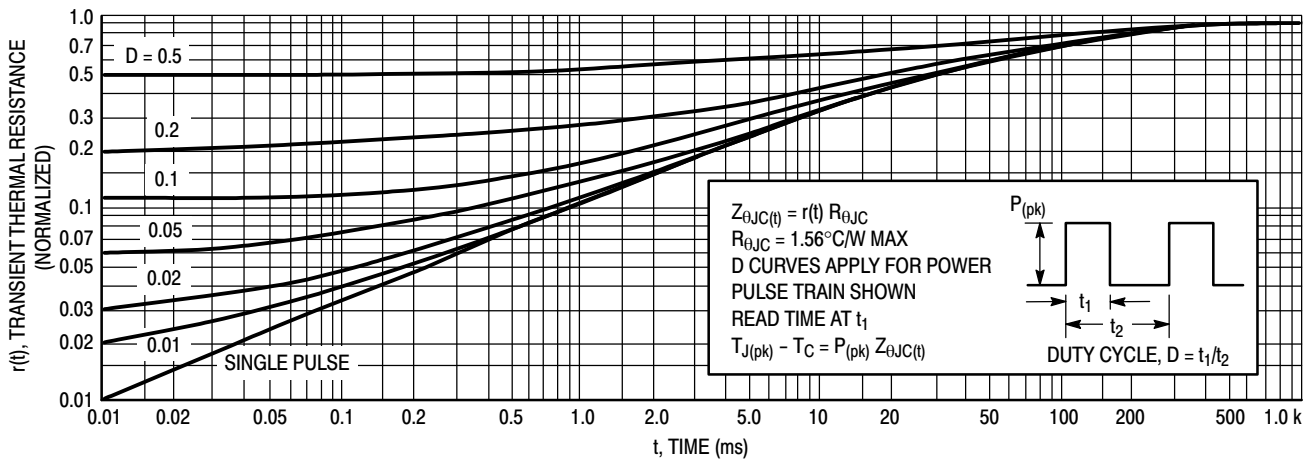

Figure 4. Thermal Response

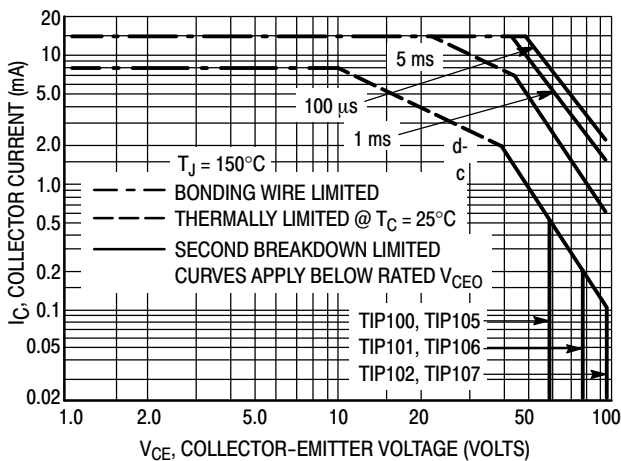

Figure 5. Active-Region Safe Operating Area

There are two limitations on the power handling ability of a transistor: average junction temperature and second breakdown. Safe operating area curves indicate  $I_C - V_{CE}$  limits of the transistor that must be observed for reliable operation; i.e., the transistor must not be subjected to greater dissipation than the curves indicate.

The data of Figure 5 is based on  $T_{J(pk)} = 150^\circ\text{C}$ ;  $T_C$  is variable depending on conditions. Second breakdown pulse limits are valid for duty cycles to 10% provided  $T_{J(pk)} < 150^\circ\text{C}$ .  $T_{J(pk)}$  may be calculated from the data in Figure 4. At high case temperatures, thermal limitations will reduce the power that can be handled to values less than the limitations imposed by second breakdown

TIP100, TIP101, TIP102 (NPN); TIP105, TIP106, TIP107 (PNP)

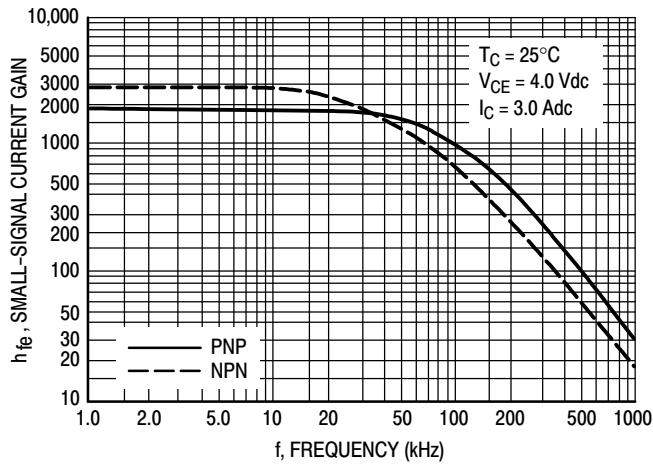

Figure 6. Small-Signal Current Gain

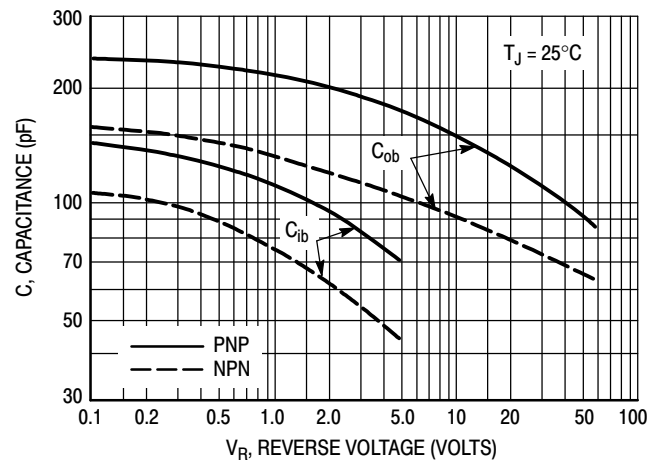

Figure 7. Capacitance

# TIP100, TIP101, TIP102 (NPN); TIP105, TIP106, TIP107 (PNP)

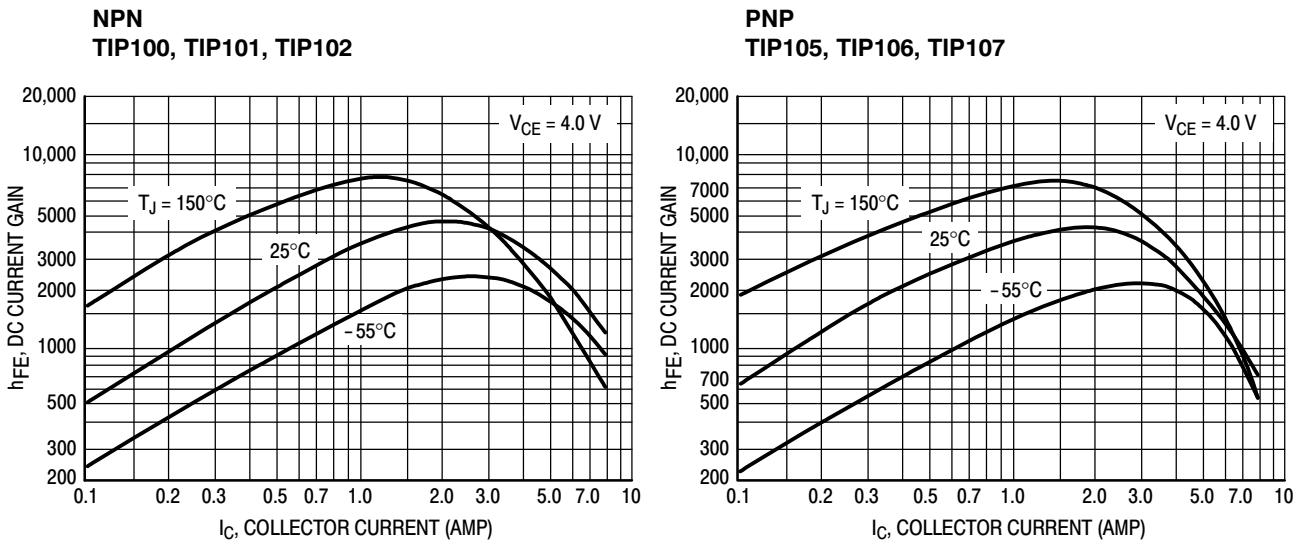

Figure 8. DC Current Gain

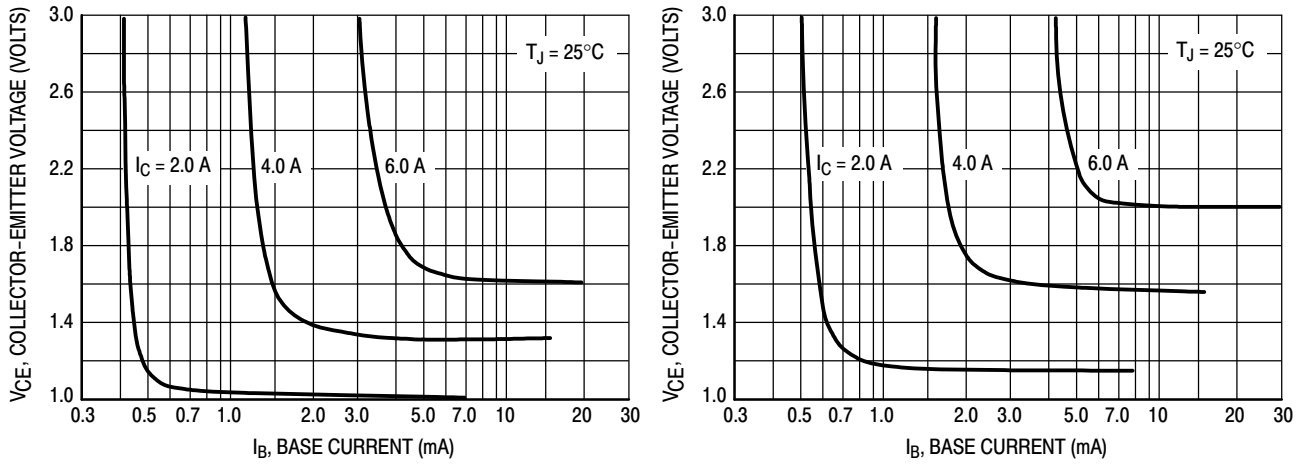

Figure 9. Collector Saturation Region

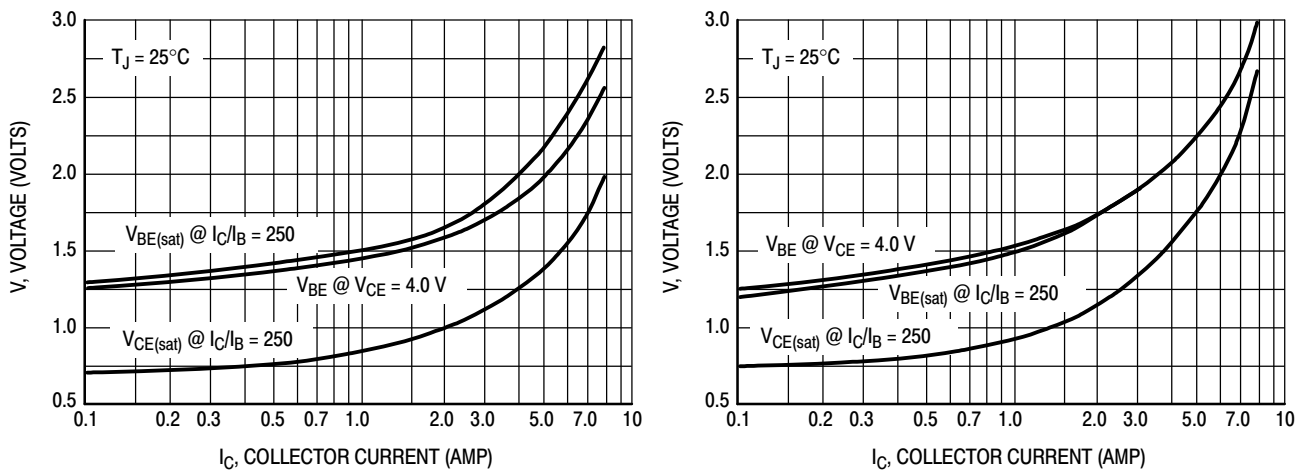
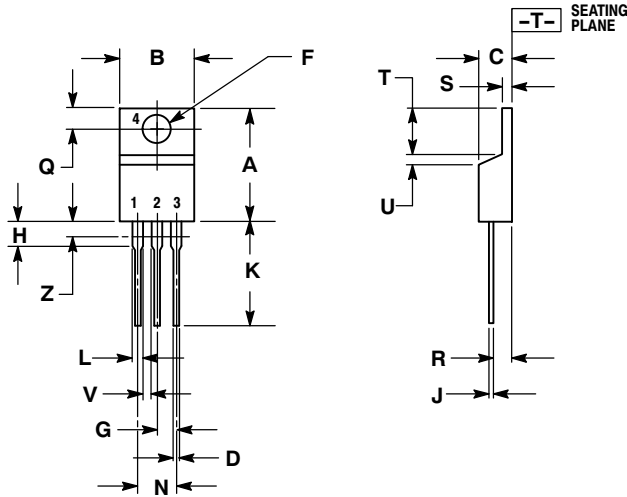

Figure 10. "On" Voltages

# TIP100, TIP101, TIP102 (NPN); TIP105, TIP106, TIP107 (PNP)

## PACKAGE DIMENSIONS

TO-220  
CASE 221A-09  
ISSUE AE



- NOTES:
1. DIMENSIONING AND TOLERANCING PER ANSI Y14.5M, 1982.
  2. CONTROLLING DIMENSION: INCH.
  3. DIMENSION Z DEFINES A ZONE WHERE ALL BODY AND LEAD IRREGULARITIES ARE ALLOWED.

DIM	INCHES		MILLIMETERS	
	MIN	MAX	MIN	MAX
A	0.570	0.620	14.48	15.75
B	0.380	0.405	9.66	10.28
C	0.160	0.190	4.07	4.82
D	0.025	0.035	0.64	0.88
F	0.142	0.161	3.61	4.09
G	0.095	0.105	2.42	2.66
H	0.110	0.155	2.80	3.93
J	0.014	0.025	0.36	0.64
K	0.500	0.562	12.70	14.27
L	0.045	0.060	1.15	1.52
N	0.190	0.210	4.83	5.33
Q	0.100	0.120	2.54	3.04
R	0.080	0.110	2.04	2.79
S	0.045	0.055	1.15	1.39
T	0.235	0.255	5.97	6.47
U	0.000	0.050	0.00	1.27
V	0.045	---	1.15	---
Z	---	0.080	---	2.04

ON Semiconductor and are registered trademarks of Semiconductor Components Industries, LLC (SCILLC). SCILLC reserves the right to make changes without further notice to any products herein. SCILLC makes no warranty, representation or guarantee regarding the suitability of its products for any particular purpose, nor does SCILLC assume any liability arising out of the application or use of any product or circuit, and specifically disclaims any and all liability, including without limitation special, consequential or incidental damages. "Typical" parameters which may be provided in SCILLC data sheets and/or specifications can and do vary in different applications and actual performance may vary over time. All operating parameters, including "Typicals" must be validated for each customer application by customer's technical experts. SCILLC does not convey any license under its patent rights nor the rights of others. SCILLC products are not designed, intended, or authorized for use as components in systems intended for surgical implant into the body, or other applications intended to support or sustain life, or for any other application in which the failure of the SCILLC product could create a situation where personal injury or death may occur. Should Buyer purchase or use SCILLC products for any such unintended or unauthorized application, Buyer shall indemnify and hold SCILLC and its officers, employees, subsidiaries, affiliates, and distributors harmless against all claims, costs, damages, and expenses, and reasonable attorney fees arising out of, directly or indirectly, any claim of personal injury or death associated with such unintended or unauthorized use, even if such claim alleges that SCILLC was negligent regarding the design or manufacture of the part. SCILLC is an Equal Opportunity/Affirmative Action Employer. This literature is subject to all applicable copyright laws and is not for resale in any manner.

### PUBLICATION ORDERING INFORMATION

**LITERATURE FULFILLMENT:**  
Literature Distribution Center for ON Semiconductor  
P.O. Box 5163, Denver, Colorado 80217 USA  
**Phone:** 303-675-2175 or 800-344-3860 Toll Free USA/Canada  
**Fax:** 303-675-2176 or 800-344-3867 Toll Free USA/Canada  
**Email:** orderlit@onsemi.com

**N. American Technical Support:** 800-282-9855 Toll Free  
USA/Canada  
**Europe, Middle East and Africa Technical Support:**  
Phone: 421 33 790 2910  
**Japan Customer Focus Center**  
Phone: 81-3-5773-3850

**ON Semiconductor Website:** [www.onsemi.com](http://www.onsemi.com)  
**Order Literature:** <http://www.onsemi.com/orderlit>  
For additional information, please contact your local Sales Representative

TIP100/D