

# 2N4921, 2N4922, 2N4923

2N4923 is a Preferred Device

## Medium-Power Plastic NPN Silicon Transistors

These high-performance plastic devices are designed for driver circuits, switching, and amplifier applications.

### Features

- Low Saturation Voltage –  $V_{CE(sat)} = 0.6 \text{ Vdc (Max) @ } I_C = 1.0 \text{ A}$
- Excellent Power Dissipation Due to Thermopad Construction –  $P_D = 30 \text{ W @ } T_C = 25^\circ\text{C}$
- Excellent Safe Operating Area
- Gain Specified to  $I_C = 1.0 \text{ A}$
- Complement to PNP 2N4918, 2N4919, 2N4920
- Pb-Free Packages are Available\*

### MAXIMUM RATINGS

Rating	Symbol	Value	Unit
Collector-Emitter Voltage	2N4921 2N4922 2N4923	$V_{CEO}$ 40 60 80	Vdc
Collector-Emitter Voltage	2N4921 2N4922 2N4923	$V_{CB}$ 40 60 80	Vdc
Emitter Base Voltage	$V_{EB}$	5.0	Vdc
Collector Current – Continuous (Note 1)	$I_C$	1.0 3.0	Adc
Base Current – Continuous	$I_B$	1.0	Adc
Total Power Dissipation @ $T_C = 25^\circ\text{C}$ Derate above $25^\circ\text{C}$	$P_D$	30 0.24	W mW/°C
Operating and Storage Junction Temperature Range	$T_J, T_{stg}$	-65 to +150	°C

### THERMAL CHARACTERISTICS (Note 2)

Characteristic	Symbol	Max	Unit
Thermal Resistance, Junction-to-Case	$\theta_{JC}$	4.16	°C/W

Maximum ratings are those values beyond which device damage can occur. Maximum ratings applied to the device are individual stress limit values (not normal operating conditions) and are not valid simultaneously. If these limits are exceeded, device functional operation is not implied, damage may occur and reliability may be affected.

1. The 1.0 A maximum  $I_C$  value is based upon JEDEC current gain requirements. The 3.0 A maximum value is based upon actual current handling capability of the device (see Figures 5 and 6).
2. Recommend use of thermal compound for lowest thermal resistance.

\*Indicates JEDEC Registered Data.

\*For additional information on our Pb-Free strategy and soldering details, please download the ON Semiconductor Soldering and Mounting Techniques Reference Manual, SOLDERRM/D.



**ON Semiconductor®**

<http://onsemi.com>

**1.0 AMPERE  
GENERAL PURPOSE  
POWER TRANSISTORS  
40-80 VOLTS, 30 WATTS**

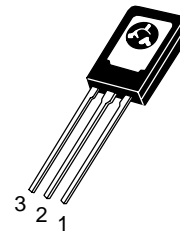

**TO-225  
CASE 77  
STYLE 1**

### MARKING DIAGRAM

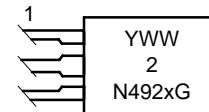

Y = Year  
WW = Work Week  
2N492x = Device Code  
x = 1, 2, or 3  
G = Pb-Free Package

### ORDERING INFORMATION

Device	Package	Shipping
2N4921	TO-225	500 Units / Box
2N4921G	TO-225 (Pb-Free)	500 Units / Box
2N4922	TO-225	500 Units / Box
2N4922G	TO-225 (Pb-Free)	500 Units / Box
2N4923	TO-225	500 Units / Box
2N4923G	TO-225 (Pb-Free)	500 Units / Box

**Preferred** devices are recommended choices for future use and best overall value.

## 2N4921, 2N4922, 2N4923

### ELECTRICAL CHARACTERISTICS ( $T_C = 25^\circ\text{C}$ unless otherwise noted)

Characteristic	Symbol	Min	Max	Unit	
<b>OFF CHARACTERISTICS</b>					
Collector-Emitter Sustaining Voltage (Note 3) ( $I_C = 0.1 \text{ Adc}$ , $I_B = 0$ )	2N4921 2N4922 2N4923	$V_{CE(sus)}$	40 60 80	– – –	Vdc
Collector Cutoff Current ( $V_{CE} = 20 \text{ Vdc}$ , $I_B = 0$ ) ( $V_{CE} = 30 \text{ Vdc}$ , $I_B = 0$ ) ( $V_{CE} = 40 \text{ Vdc}$ , $I_B = 0$ )	2N4921 2N4922 2N4923	$I_{CEO}$	– – –	0.5 0.5 0.5	mAdc
Collector Cutoff Current ( $V_{CE} = \text{Rated } V_{CEO}$ , $V_{EB(off)} = 1.5 \text{ Vdc}$ ) ( $V_{CE} = \text{Rated } V_{CEO}$ , $V_{EB(off)} = 1.5 \text{ Vdc}$ , $T_C = 125^\circ\text{C}$ )		$I_{CEX}$	– –	0.1 0.5	mAdc
Collector Cutoff Current ( $V_{CB} = \text{Rated } V_{CB}$ , $I_E = 0$ )		$I_{CBO}$	–	0.1	mAdc
Emitter Cutoff Current ( $V_{EB} = 5.0 \text{ Vdc}$ , $I_C = 0$ )		$I_{EBO}$	–	1.0	mAdc
<b>ON CHARACTERISTICS</b>					
DC Current Gain (Note 3) ( $I_C = 50 \text{ mAdc}$ , $V_{CE} = 1.0 \text{ Vdc}$ ) ( $I_C = 500 \text{ mAdc}$ , $V_{CE} = 1.0 \text{ Vdc}$ ) ( $I_C = 1.0 \text{ Adc}$ , $V_{CE} = 1.0 \text{ Vdc}$ )		$h_{FE}$	40 30 10	– 150 –	–
Collector-Emitter Saturation Voltage (Note 3) ( $I_C = 1.0 \text{ Adc}$ , $I_B = 0.1 \text{ Adc}$ )		$V_{CE(sat)}$	–	0.6	Vdc
Base-Emitter Saturation Voltage (Note 3) ( $I_C = 1.0 \text{ Adc}$ , $I_B = 0.1 \text{ Adc}$ )		$V_{BE(sat)}$	–	1.3	Vdc
Base-Emitter On Voltage (Note 3) ( $I_C = 1.0 \text{ Adc}$ , $V_{CE} = 1.0 \text{ Vdc}$ )		$V_{BE(on)}$	–	1.3	Vdc
<b>SMALL-SIGNAL CHARACTERISTICS</b>					
Current-Gain – Bandwidth Product ( $I_C = 250 \text{ mAdc}$ , $V_{CE} = 10 \text{ Vdc}$ , $f = 1.0 \text{ MHz}$ )		$f_T$	3.0	–	MHz
Output Capacitance ( $V_{CB} = 10 \text{ Vdc}$ , $I_E = 0$ , $f = 100 \text{ kHz}$ )		$C_{ob}$	–	100	pF
Small-Signal Current Gain ( $I_C = 250 \text{ mAdc}$ , $V_{CE} = 10 \text{ Vdc}$ , $f = 1.0 \text{ kHz}$ )		$h_{fe}$	25	–	–

3. Pulse Test:  $PW \approx 300 \mu\text{s}$ , Duty Cycle  $\approx 2.0\%$ .

\*Indicates JEDEC Registered Data.

## 2N4921, 2N4922, 2N4923

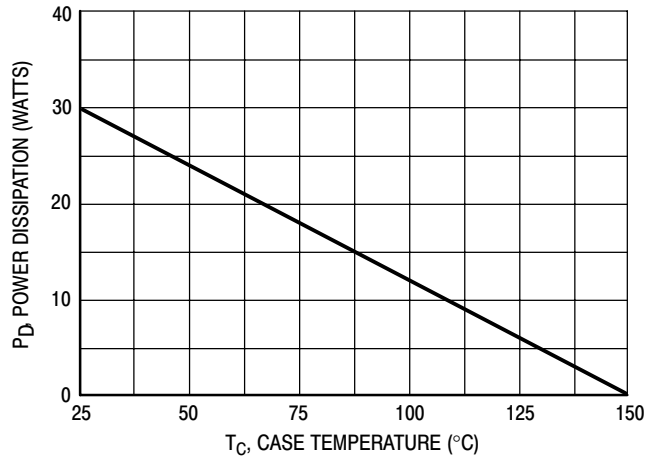

Figure 1. Power Derating

Safe Area Curves are indicated by Figure 5. All limits are applicable and must be observed.

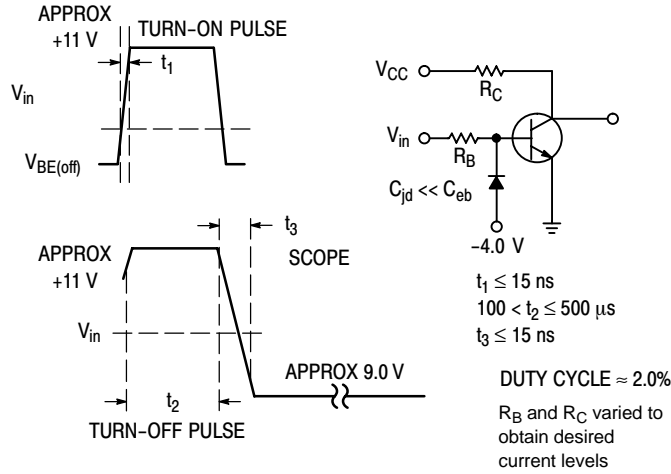

Figure 2. Switching Time Equivalent Circuit

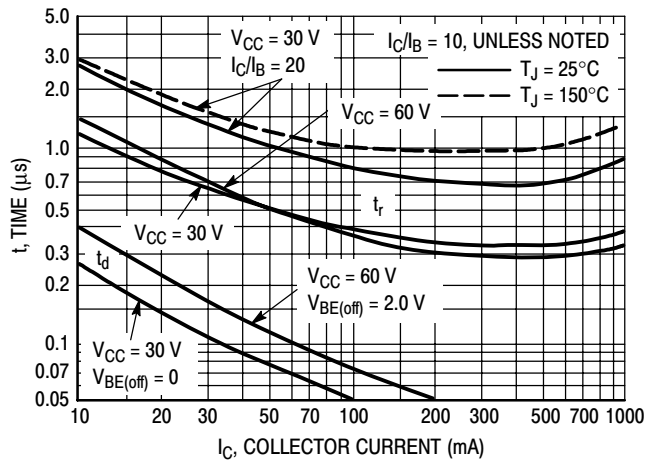

Figure 3. Turn-On Time

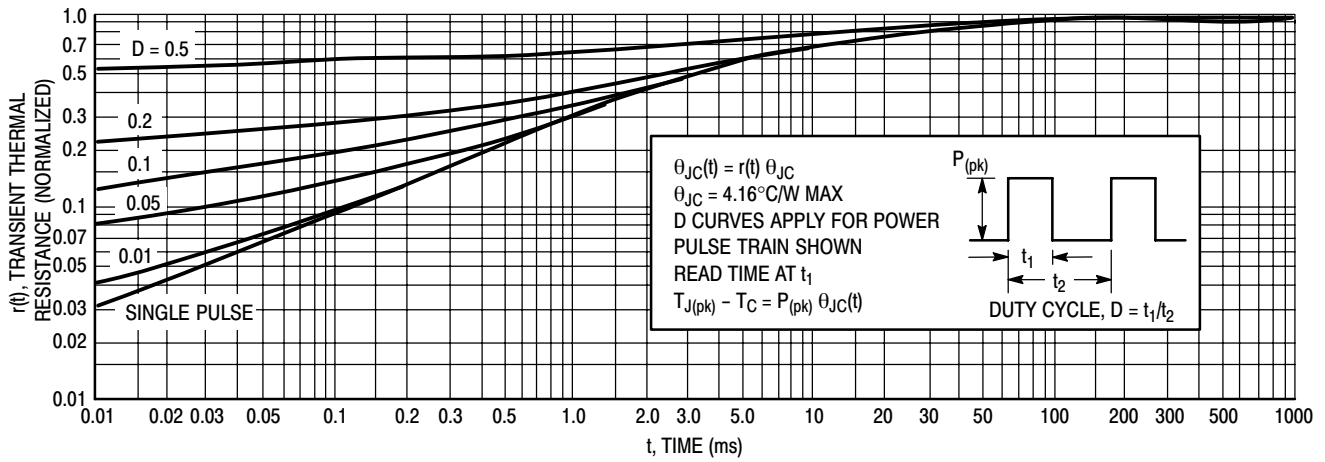

Figure 4. Thermal Response

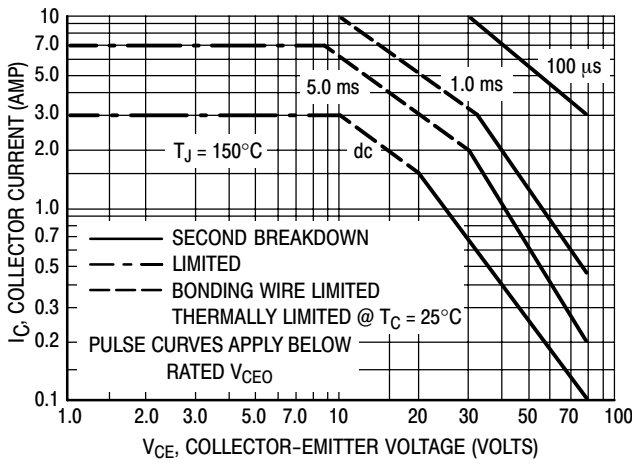

Figure 5. Active-Region Safe Operating Area

There are two limitations on the power handling ability of a transistor: average junction temperature and second breakdown. Safe operating area curves indicate  $I_C - V_{CE}$  operation i.e., the transistor must not be subjected to greater dissipation than the curves indicate.

The data of Figure 5 is based on  $T_{J(pk)} = 150^{\circ}\text{C}$ ;  $T_C$  is variable depending on conditions. Second breakdown pulse limits are valid for duty cycles to 10% provided  $T_{J(pk)} \leq 150^{\circ}\text{C}$ . At high case temperatures, thermal limitations will reduce the power that can be handled to values less than the limitations imposed by second breakdown.

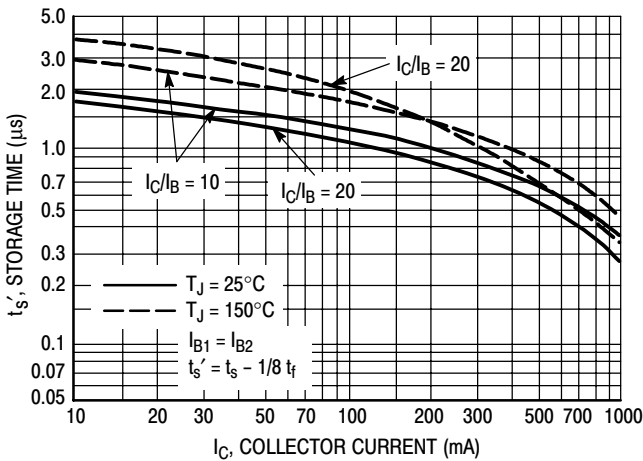

Figure 6. Storage Time

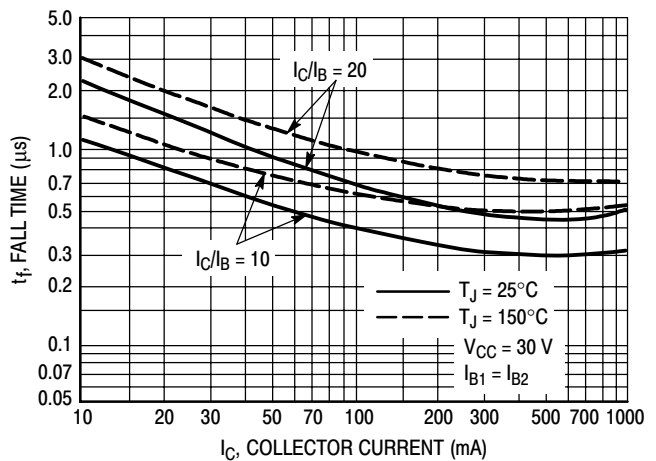

Figure 7. Fall Time

# 2N4921, 2N4922, 2N4923

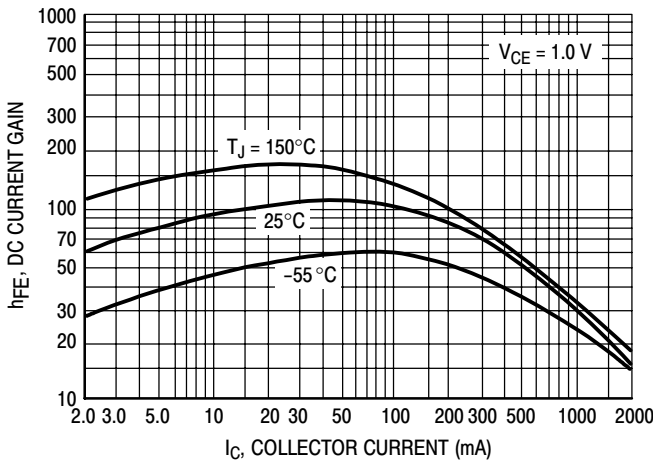

Figure 8. Current Gain

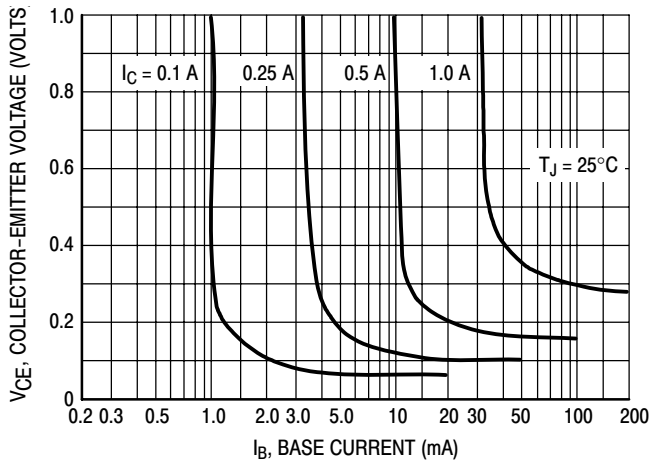

Figure 9. Collector Saturation Region

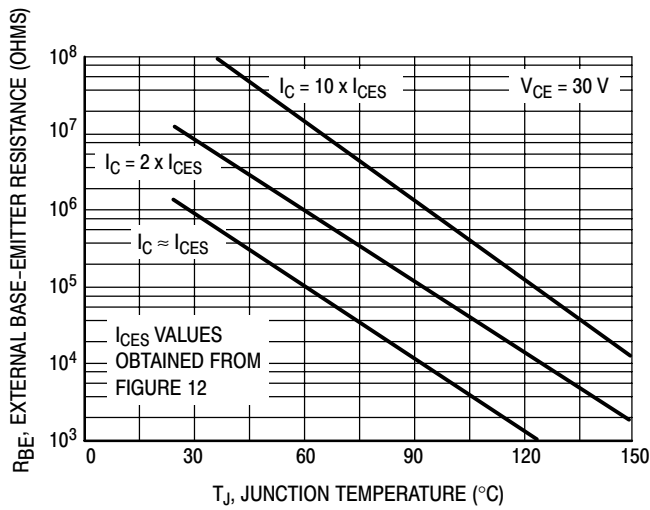

Figure 10. Effects of Base-Emitter Resistance

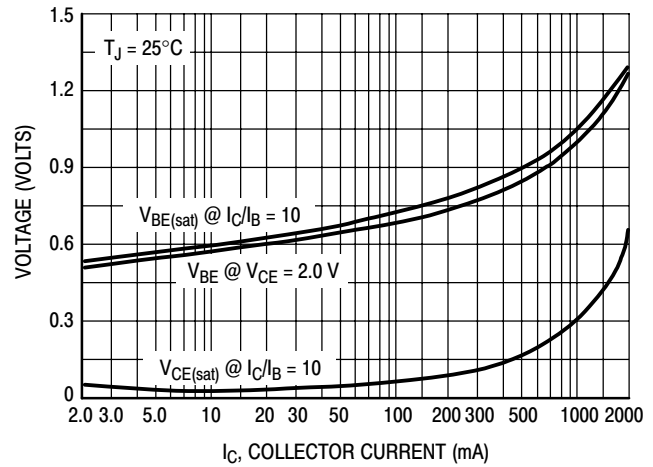

Figure 11. "On" Voltage

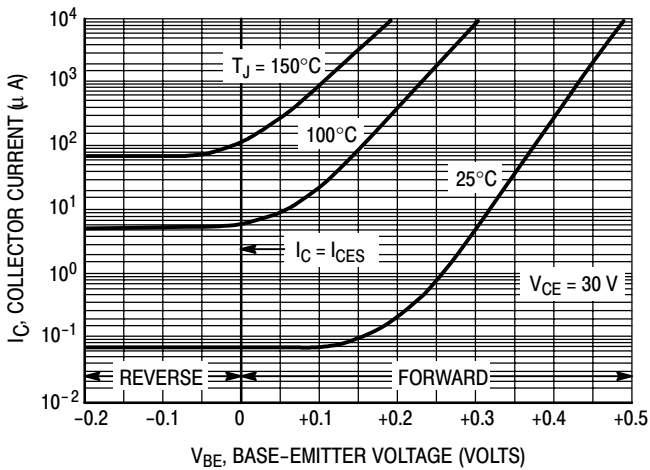

Figure 12. Collector Cut-Off Region

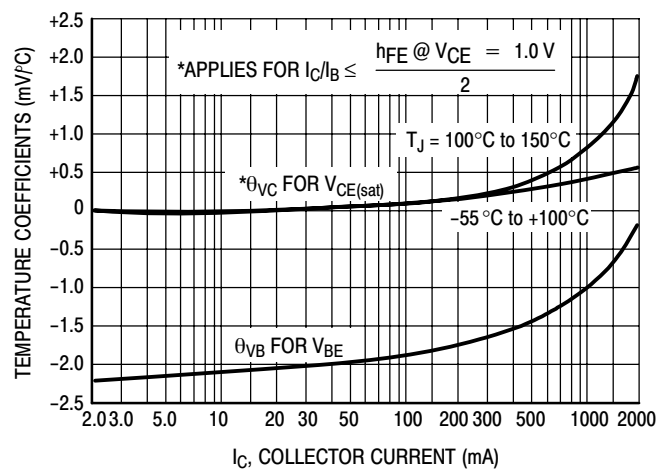
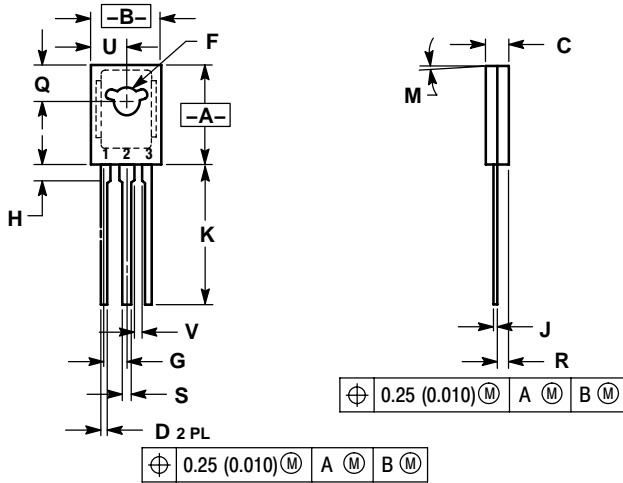

Figure 13. Temperature Coefficients

# 2N4921, 2N4922, 2N4923

## PACKAGE DIMENSIONS

TO-225  
CASE 77-09  
ISSUE Z



### NOTES:

1. DIMENSIONING AND TOLERANCING PER ANSI Y14.5M, 1982.
2. CONTROLLING DIMENSION: INCH.
3. 077-01 THRU -08 OBSOLETE, NEW STANDARD 077-09.

DIM	INCHES		MILLIMETERS	
	MIN	MAX	MIN	MAX
A	0.425	0.435	10.80	11.04
B	0.295	0.305	7.50	7.74
C	0.095	0.105	2.42	2.66
D	0.020	0.026	0.51	0.66
F	0.115	0.130	2.93	3.30
G	0.094 BSC		2.39 BSC	
H	0.050	0.095	1.27	2.41
J	0.015	0.025	0.39	0.63
K	0.575	0.655	14.61	16.63
M	5° TYP		5° TYP	
Q	0.148	0.158	3.76	4.01
R	0.045	0.065	1.15	1.65
S	0.025	0.035	0.64	0.88
U	0.145	0.155	3.69	3.93
V	0.040	---	1.02	---

### STYLE 1:

1. EMITTER
2. COLLECTOR
3. BASE

ON Semiconductor and are registered trademarks of Semiconductor Components Industries, LLC (SCILLC). SCILLC reserves the right to make changes without further notice to any products herein. SCILLC makes no warranty, representation or guarantee regarding the suitability of its products for any particular purpose, nor does SCILLC assume any liability arising out of the application or use of any product or circuit, and specifically disclaims any and all liability, including without limitation special, consequential or incidental damages. "Typical" parameters which may be provided in SCILLC data sheets and/or specifications can and do vary in different applications and actual performance may vary over time. All operating parameters, including "Typicals" must be validated for each customer application by customer's technical experts. SCILLC does not convey any license under its patent rights nor the rights of others. SCILLC products are not designed, intended, or authorized for use as components in systems intended for surgical implant into the body, or other applications intended to support or sustain life, or for any other application in which the failure of the SCILLC product could create a situation where personal injury or death may occur. Should Buyer purchase or use SCILLC products for any such unintended or unauthorized application, Buyer shall indemnify and hold SCILLC and its officers, employees, subsidiaries, affiliates, and distributors harmless against all claims, costs, damages, and expenses, and reasonable attorney fees arising out of, directly or indirectly, any claim of personal injury or death associated with such unintended or unauthorized use, even if such claim alleges that SCILLC was negligent regarding the design or manufacture of the part. SCILLC is an Equal Opportunity/Affirmative Action Employer. This literature is subject to all applicable copyright laws and is not for resale in any manner.

### PUBLICATION ORDERING INFORMATION

#### LITERATURE FULFILLMENT:

Literature Distribution Center for ON Semiconductor  
P.O. Box 61312, Phoenix, Arizona 85082-1312 USA  
Phone: 480-829-7710 or 800-344-3860 Toll Free USA/Canada  
Fax: 480-829-7709 or 800-344-3867 Toll Free USA/Canada  
Email: orderlit@onsemi.com

N. American Technical Support: 800-282-9855 Toll Free  
USA/Canada

Japan: ON Semiconductor, Japan Customer Focus Center  
2-9-1 Kamimeguro, Meguro-ku, Tokyo, Japan 153-0051  
Phone: 81-3-5773-3850

ON Semiconductor Website: <http://onsemi.com>

Order Literature: <http://www.onsemi.com/litorder>

For additional information, please contact your local Sales Representative.

2N4921/D