

ZXTP25040DZ

40V PNP medium power transistor in SOT89

Summary

$BV_{CEO} > -40V$

$BV_{ECO} > -3V$

$I_{C(cont)} = -3.5A$

$R_{CE(sat)} = 55m\Omega$

$V_{CE(sat)} < -90mV @ 1A$

$P_D = 2.4W$

Complementary part number ZXTN25040DZ

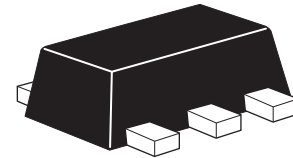

Description

Advanced process capability and package design have been used to maximize the power handling and performance of this small outline transistor. The compact size and ratings of this device make it ideally suited to applications where space is at a premium.

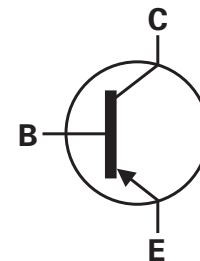

Features

- High power dissipation SOT89 package
- High peak current
- Low saturation voltage
- 3V reverse blocking voltage

Applications

- MOSFET and IGBT gate driving
- DC - DC converters
- Motor drive
- High side driver

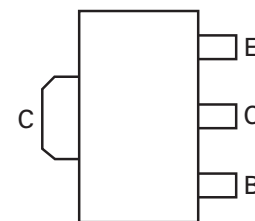

Pinout - top view

Ordering information

Device	Reel size (inches)	Tape width (mm)	Quantity per reel
ZXTP25040DZTA	7	12	1000

Device marking

- 1L6

ZXTP25040DZ

Absolute maximum ratings

Parameter	Symbol	Limit	Unit
Collector-Base voltage	V_{CBO}	-45	V
Collector-Emitter voltage (forward blocking)	V_{CEO}	-40	V
Emitter-Collector voltage (reverse blocking)	V_{ECO}	-3	V
Emitter-Base voltage	V_{EBO}	-7	V
Continuous Collector current ^(c)	I_C	-3	A
Base current	I_B	-1	A
Peak pulse current	I_{CM}	-9	A
Power dissipation at $T_A = 25^\circ\text{C}^{(a)}$	P_D	1.1	W
Linear derating factor		8.8	mW/°C
Power dissipation at $T_A = 25^\circ\text{C}^{(b)}$	P_D	1.8	W
Linear derating factor		14.4	mW/°C
Power dissipation at $T_A = 25^\circ\text{C}^{(c)}$	P_D	2.4	W
Linear derating factor		19.2	mW/°C
Power dissipation at $T_A = 25^\circ\text{C}^{(d)}$	P_D	4.46	W
Linear derating factor		35.7	mW/°C
Power dissipation at $T_C = 25^\circ\text{C}^{(e)}$	P_D	15.7	W
Linear derating factor		126	mW/°C
Operating and storage temperature range	T_j, T_{stg}	-55 to 150	°C

Thermal resistance

Parameter	Symbol	Limit	Unit
Junction to ambient ^(a)	$R_{\theta JA}$	117	°C/W
Junction to ambient ^(b)	$R_{\theta JA}$	68	°C/W
Junction to ambient ^(c)	$R_{\theta JA}$	51	°C/W
Junction to ambient ^(d)	$R_{\theta JA}$	28	°C/W
Junction to case ^(e)	$R_{\theta JC}$	7.95	°C/W

NOTES:

(a) For a device surface mounted on 15mm x 15mm x 0.6mm FR4 PCB with high coverage of single sided 1oz copper, in still air conditions.

(b) Mounted on 25mm x 25mm x 0.6mm FR4 PCB with high coverage of single sided 1oz copper, in still air conditions.

(c) Mounted on 50mm x 50mm x 0.6mm FR4 PCB with high coverage of single sided 2oz copper, in still air conditions.

(d) As (c) above measured at $t < 5$ seconds.

(e) Junction to case (collector tab). Typical

ZXTP25040DZ

Thermal characteristics

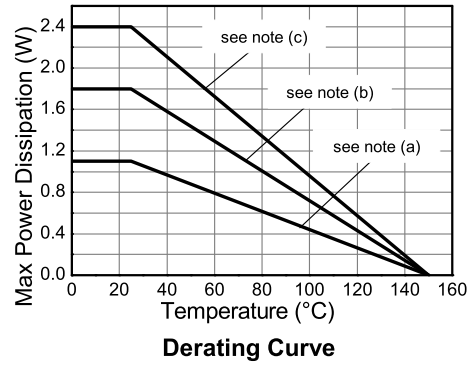
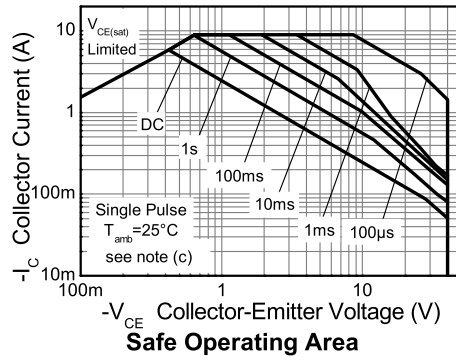

ZXTP25040DZ

Thermal characteristics

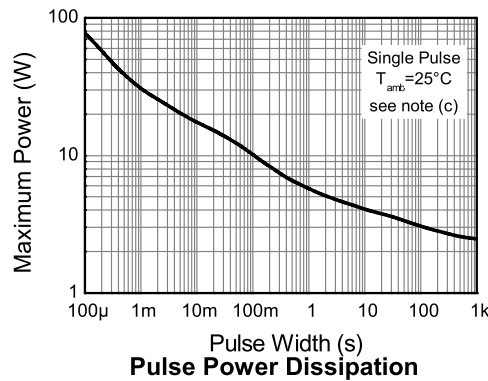
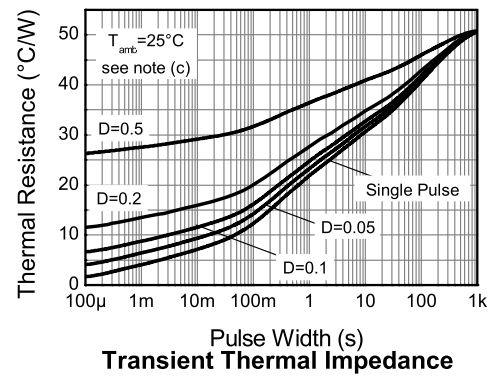
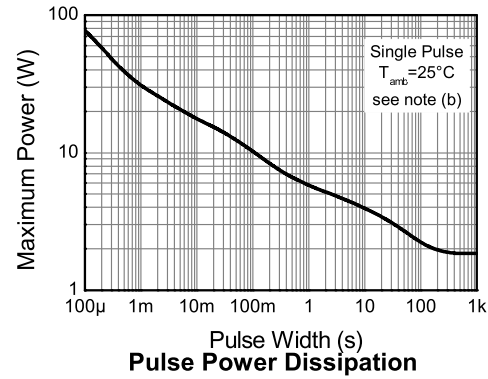
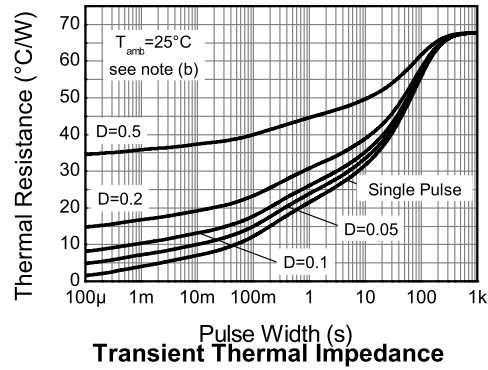
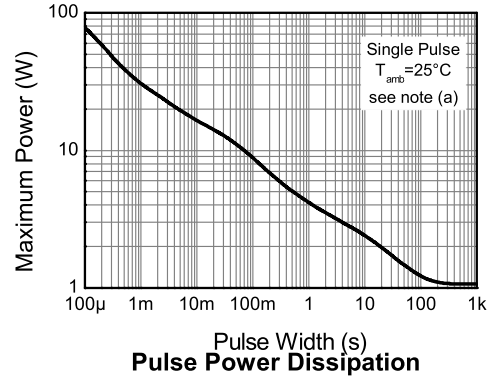
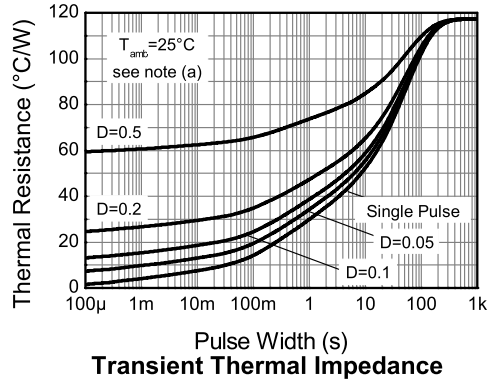

ZXTP25040DZ

Electrical characteristics (at $T_{amb} = 25^{\circ}\text{C}$ unless otherwise stated)

Parameter	Symbol	Min.	Typ.	Max.	Unit	Conditions
Collector-Base breakdown voltage	BV_{CBO}	-45	-75		V	$I_C = -100\mu\text{A}$
Collector-Emitter breakdown voltage (base open)	BV_{CEO}	-40	-65		V	$I_C = -10\text{mA}^{(*)}$
Emitter-Collector breakdown voltage (reverse blocking)	BV_{ECO}	-3	-8.7		V	$I_E = -100\mu\text{A}$
Emitter-Base breakdown voltage	BV_{EBO}	-7	-8.2		V	$I_E = -100\mu\text{A}$
Collector cut-off current	I_{CBO}		<-1	-50 -0.5	nA μA	$V_{CB} = -45\text{V}$ $V_{CB} = -45\text{V}, T_{amb} = 100^{\circ}\text{C}$
Emitter cut-off current	I_{EBO}		<-1	-50	nA	$V_{EB} = -5.6\text{V}$
Collector-Emitter saturation voltage	$V_{CE(sat)}$		-170 -70 -215	-265 -90 -350	mV mV mV	$I_C = -1\text{A}, I_B = -20\text{mA}^{(*)}$ $I_C = -1\text{A}, I_B = -100\text{mA}^{(*)}$ $I_C = -3.5\text{A}, I_B = -350\text{mA}^{(*)}$
Base-Emitter saturation voltage	$V_{BE(sat)}$		-970	-1050	mV	$I_C = -3.5\text{A}, I_B = -350\text{mA}^{(*)}$
Base-emitter turn-on voltage	$V_{BE(on)}$		-870	-950	mV	$I_C = -3.5\text{A}, V_{CE} = -2\text{V}^{(*)}$
Static forward current transfer ratio	h_{FE}	300 200 20	450 300 50	900		$I_C = -10\text{mA}, V_{CE} = -2\text{V}^{(*)}$ $I_C = -1\text{A}, V_{CE} = -2\text{V}^{(*)}$ $I_C = -3.5\text{A}, V_{CE} = -2\text{V}^{(*)}$
Transition frequency	f_T		270		MHz	$I_C = -50\text{mA}, V_{CE} = -10\text{V}$ $f = 100\text{MHz}$
Input capacitance	C_{ibo}		142		pF	$V_{EB} = -0.5\text{V}, f = 1\text{MHz}^{(*)}$
Output capacitance	C_{obo}		17.4		pF	$V_{CB} = -10\text{V}, f = 1\text{MHz}^{(*)}$
Turn-on time	$t_{(on)}$		75.5		ns	$V_{CC} = -15\text{V}, I_C = -750\text{mA},$
Turn-off time	$t_{(off)}$		320		ns	$I_{B1} = -I_{B2} = -15\text{mA},$

NOTES:

(*) Measured under pulsed conditions. Pulse width $\leq 300\mu\text{s}$; duty cycle $\leq 2\%$.

ZXTP25040DZ

Typical characteristics

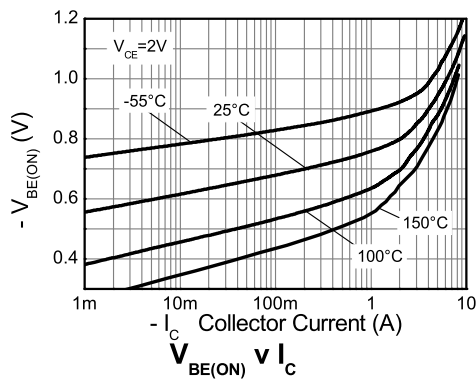
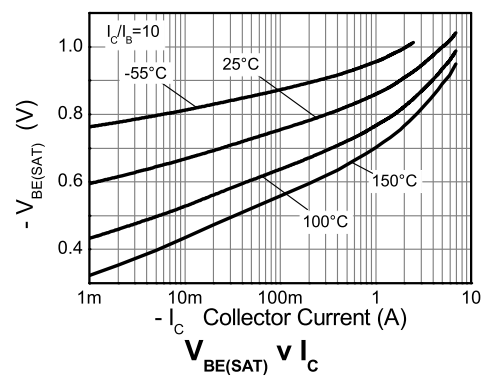
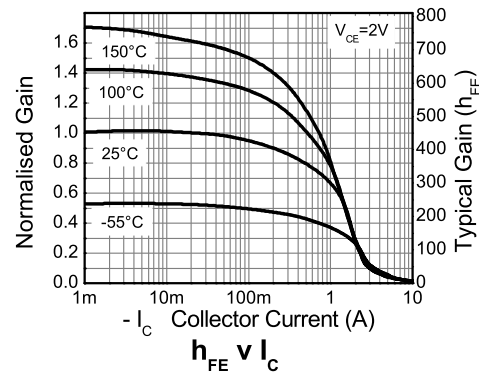
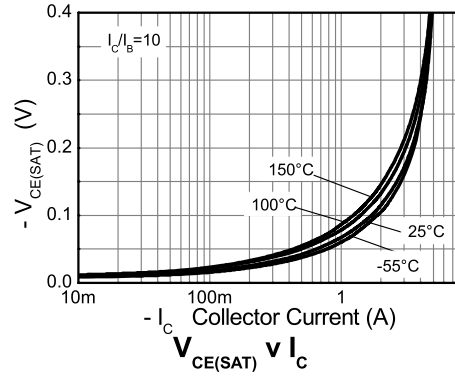
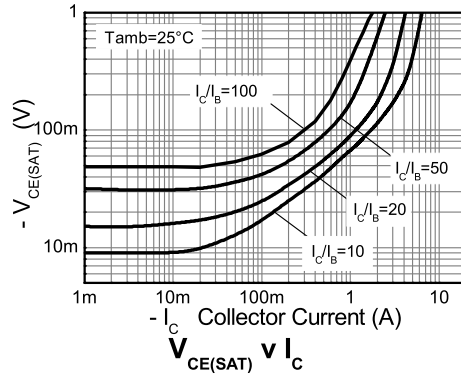

ZXTP25040DZ

Package outline - SOT89

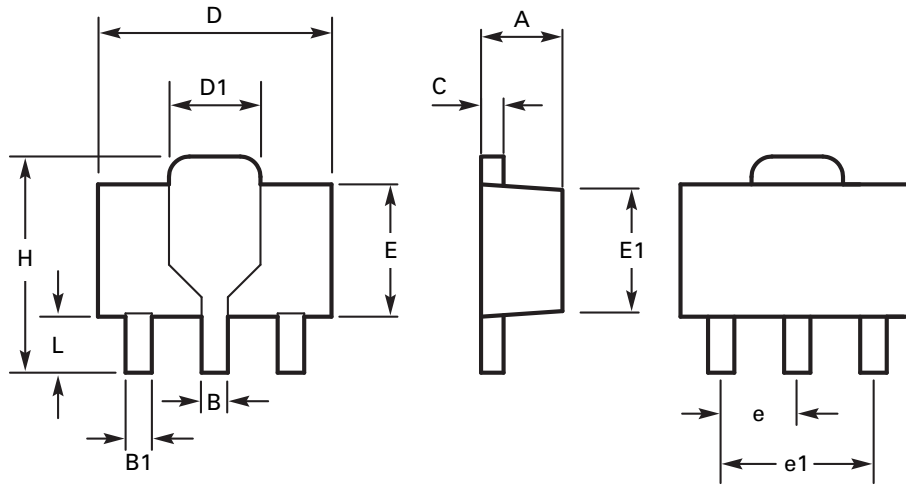

DIM	Millimeters		Inches		DIM	Millimeters		Inches	
	Min	Max	Min	Max		Min	Max	Min	Max
A	1.40	1.60	0.550	0.630	E	2.29	2.60	0.090	0.102
B	0.44	0.56	0.017	0.022	E1	2.13	2.29	0.084	0.090
B1	0.36	0.48	0.014	0.019	e	1.50 BSC		0.059 BSC	
C	0.35	0.44	0.014	0.017	e1	3.00 BSC		0.118 BSC	
D	4.40	4.60	0.173	0.181	H	3.94	4.25	0.155	0.167
D1	1.52	1.83	0.064	0.072	L	0.89	1.20	0.035	0.047

Note: Controlling dimensions are in millimeters. Approximate dimensions are provided in inches

ZXTP25040DZ

Definitions

Product change

Zetex Semiconductors reserves the right to alter, without notice, specifications, design, price or conditions of supply of any product or service. Customers are solely responsible for obtaining the latest relevant information before placing orders.

Applications disclaimer

The circuits in this design/application note are offered as design ideas. It is the responsibility of the user to ensure that the circuit is fit for the user's application and meets with the user's requirements. No representation or warranty is given and no liability whatsoever is assumed by Zetex with respect to the accuracy or use of such information, or infringement of patents or other intellectual property rights arising from such use or otherwise. Zetex does not assume any legal responsibility or will not be held legally liable (whether in contract, tort (including negligence), breach of statutory duty, restriction or otherwise) for any damages, loss of profit, business, contract, opportunity or consequential loss in the use of these circuit applications, under any circumstances.

Life support

Zetex products are specifically not authorized for use as critical components in life support devices or systems without the express written approval of the Chief Executive Officer of Zetex Semiconductors plc. As used herein:

A. Life support devices or systems are devices or systems which:

1. are intended to implant into the body

or

2. support or sustain life and whose failure to perform when properly used in accordance with instructions for use provided in the labeling can be reasonably expected to result in significant injury to the user.

B. A critical component is any component in a life support device or system whose failure to perform can be reasonably expected to cause the failure of the life support device or to affect its safety or effectiveness.

Reproduction

The product specifications contained in this publication are issued to provide outline information only which (unless agreed by the company in writing) may not be used, applied or reproduced for any purpose or form part of any order or contract or be regarded as a representation relating to the products or services concerned.

Terms and Conditions

All products are sold subjects to Zetex' terms and conditions of sale, and this disclaimer (save in the event of a conflict between the two when the terms of the contract shall prevail) according to region, supplied at the time of order acknowledgement.

For the latest information on technology, delivery terms and conditions and prices, please contact your nearest Zetex sales office.

Quality of product

Zetex is an ISO 9001 and TS16949 certified semiconductor manufacturer.

To ensure quality of service and products we strongly advise the purchase of parts directly from Zetex Semiconductors or one of our regionally authorized distributors. For a complete listing of authorized distributors please visit: www.zetex.com/salesnetwork

Zetex Semiconductors does not warrant or accept any liability whatsoever in respect of any parts purchased through unauthorized sales channels.

ESD (Electrostatic discharge)

Semiconductor devices are susceptible to damage by ESD. Suitable precautions should be taken when handling and transporting devices. The possible damage to devices depends on the circumstances of the handling and transporting, and the nature of the device. The extent of damage can vary from immediate functional or parametric malfunction to degradation of function or performance in use over time. Devices suspected of being affected should be replaced.

Green compliance

Zetex Semiconductors is committed to environmental excellence in all aspects of its operations which includes meeting or exceeding regulatory requirements with respect to the use of hazardous substances. Numerous successful programs have been implemented to reduce the use of hazardous substances and/or emissions.

All Zetex components are compliant with the RoHS directive, and through this it is supporting its customers in their compliance with WEEE and ELV directives.

Product status key:

"Preview"	Future device intended for production at some point. Samples may be available
"Active"	Product status recommended for new designs
"Last time buy (LTB)"	Device will be discontinued and last time buy period and delivery is in effect
"Not recommended for new designs"	Device is still in production to support existing designs and production
"Obsolete"	Production has been discontinued

Datasheet status key:

"Draft version"	This term denotes a very early datasheet version and contains highly provisional information, which may change in any manner without notice.
"Provisional version"	This term denotes a pre-release datasheet. It provides a clear indication of anticipated performance. However, changes to the test conditions and specifications may occur, at any time and without notice.
"Issue"	This term denotes an issued datasheet containing finalized specifications. However, changes to specifications may occur, at any time and without notice.

Zetex sales offices

Europe	Americas	Asia Pacific	Corporate Headquarters
Zetex GmbH Kustermann-park Balanstraße 59 D-81541 München Germany Telefon: (49) 89 45 49 49 0 Fax: (49) 89 45 49 49 49 europe.sales@zetex.com	Zetex Inc 700 Veterans Memorial Highway Hauppauge, NY 11788 USA Telephone: (1) 631 360 2222 Fax: (1) 631 360 8222 usa.sales@zetex.com	Zetex (Asia Ltd) 3701-04 Metroplaza Tower 1 Hing Fong Road, Kwai Fong Hong Kong Telephone: (852) 26100 611 Fax: (852) 24250 494 asia.sales@zetex.com	Zetex Semiconductors plc Zetex Technology Park, Chadderton Oldham, OL9 9LL United Kingdom Telephone: (44) 161 622 4444 Fax: (44) 161 622 4446 hq@zetex.com

© 2007 Published by Zetex Semiconductors plc

Issue 1- December 2007

8

www.zetex.com

© Zetex Semiconductors plc 2007