

BF720T1G, BF720T3G

NPN Silicon Transistor

Features

- These Devices are Pb-Free, Halogen Free/BFR Free and are RoHS Compliant

MAXIMUM RATINGS

Rating	Symbol	Value	Unit
Collector - Emitter Voltage	V_{CEO}	300	Vdc
Collector - Base Voltage	V_{CBO}	300	Vdc
Collector - Emitter Voltage	V_{CER}	300	Vdc
Emitter - Base Voltage	V_{EBO}	5.0	Vdc
Collector Current	I_C	100	mAdc
Total Power Dissipation up to $T_A = 25^\circ\text{C}$	P_D	1.5	W
Storage Temperature Range	T_{stg}	-65 to +150	$^\circ\text{C}$
Junction Temperature	T_J	150	$^\circ\text{C}$

THERMAL CHARACTERISTICS

Characteristic	Symbol	Max	Unit
Thermal Resistance, Junction-to-Ambient (Note 1)	$R_{\theta JA}$	83.3	$^\circ\text{C}/\text{W}$

Stresses exceeding Maximum Ratings may damage the device. Maximum Ratings are stress ratings only. Functional operation above the Recommended Operating Conditions is not implied. Extended exposure to stresses above the Recommended Operating Conditions may affect device reliability.

1. Device mounted on a glass epoxy printed circuit board 1.575 in. x 1.575 in. x 0.059 in.; mounting pad for the collector lead min. 0.93 in².



ON Semiconductor®

<http://onsemi.com>

NPN SILICON TRANSISTOR SURFACE MOUNT

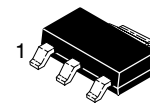
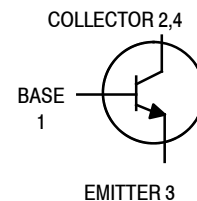

SOT-223 (TO-261)
CASE 318E
STYLE 1

MARKING DIAGRAM

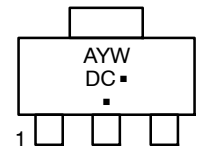

A = Assembly Location
Y = Year
W = Work Week
DC = Device Code
▪ = Pb-Free Package

(Note: Microdot may be in either location)

ORDERING INFORMATION

Device	Package	Shipping [†]
BF720T1G	SOT-223 (Pb-Free)	1000 / Tape & Reel
BF720T3G	SOT-223 (Pb-Free)	4000 / Tape & Reel

[†]For information on tape and reel specifications, including part orientation and tape sizes, please refer to our Tape and Reel Packaging Specifications Brochure, BRD8011/D.

BF720T1G, BF720T3G

ELECTRICAL CHARACTERISTICS (T_A = 25°C unless otherwise noted)

Characteristics	Symbol	Min	Max	Unit
OFF CHARACTERISTICS				
Collector-Emitter Breakdown Voltage (I _C = 1.0 mA _{dc} , I _B = 0)	V _{(BR)CEO}	300	-	V _{dc}
Collector-Base Breakdown Voltage (I _C = 100 μA _{dc} , I _E = 0)	V _{(BR)CBO}	300	-	V _{dc}
Collector-Emitter Breakdown Voltage (I _C = 100 μA _{dc} , R _{BE} = 2.7 kΩ)	V _{(BR)CER}	300	-	V _{dc}
Emitter-Base Breakdown Voltage (I _E = 10 μA _{dc} , I _C = 0)	V _{(BR)EBO}	5.0	-	V _{dc}
Collector-Base Cutoff Current (V _{CB} = 200 V _{dc} , I _E = 0)	I _{CBO}	-	10	nA _{dc}
Collector-Emitter Cutoff Current (V _{CE} = 250 V _{dc} , R _{BE} = 2.7 kΩ) (V _{CE} = 200 V _{dc} , R _{BE} = 2.7 kΩ, T _J = 150°C)	I _{CER}	-	50 10	nA _{dc} μA _{dc}
ON CHARACTERISTICS				
DC Current Gain (I _C = 25 mA _{dc} , V _{CE} = 20 V _{dc})	h _{FE}	50	-	-
Collector-Emitter Saturation Voltage (I _C = 30 mA _{dc} , I _B = 5.0 mA _{dc})	V _{CE(sat)}	-	0.6	V _{dc}
DYNAMIC CHARACTERISTICS				
Current-Gain - Bandwidth Product (I _C = 10 mA _{dc} , V _{CE} = 10 V _{dc} , f = 35 MHz)	f _T	60	-	MHz
Feedback Capacitance (V _{CE} = 30 V _{dc} , I _C = 0, f = 1.0 MHz)	C _{re}	-	1.6	pF

BF720T1G, BF720T3G

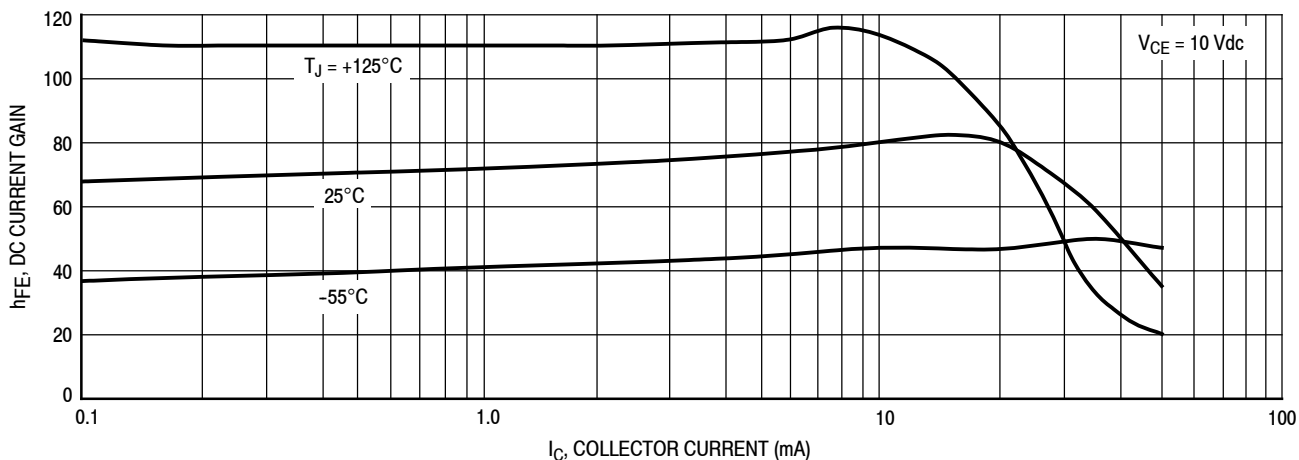

Figure 1. DC Current Gain

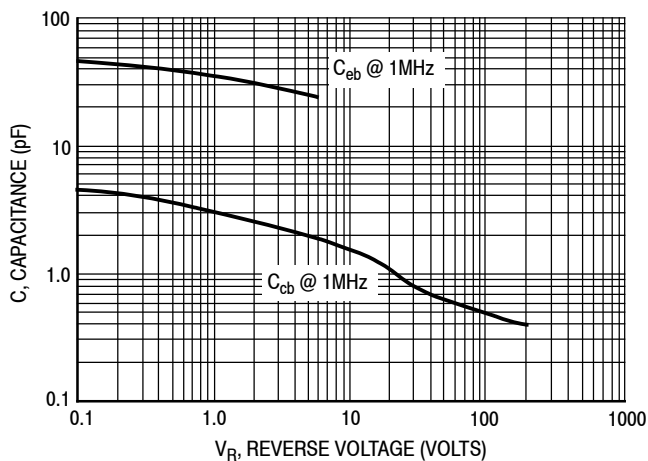

Figure 2. Capacitance

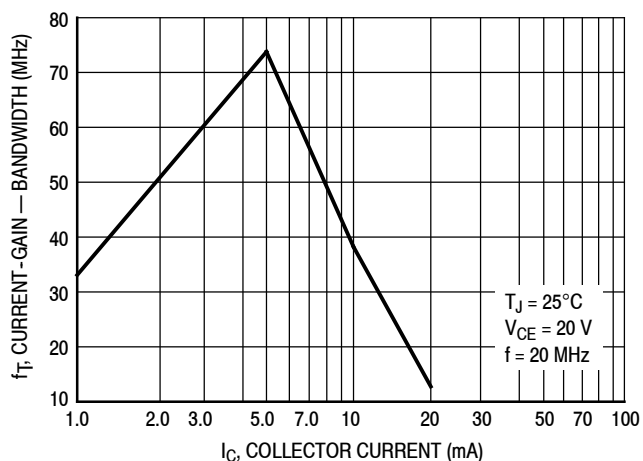

Figure 3. Current-Gain - Bandwidth

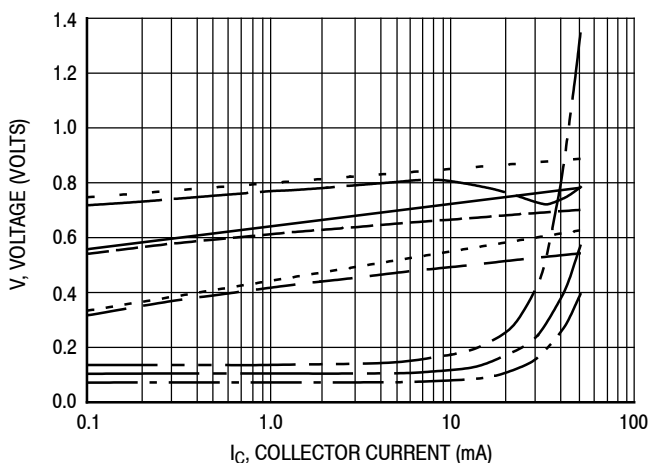

Figure 4. "ON" Voltages

- $V_{CE(sat)}$ @ 25°C, $I_C/I_B = 10$
- $V_{CE(sat)}$ @ 125°C, $I_C/I_B = 10$
- $V_{CE(sat)}$ @ -55°C, $I_C/I_B = 10$
- $V_{BE(on)}$ @ 25°C, $V_{CE} = 10$ V
- $V_{BE(on)}$ @ 125°C, $V_{CE} = 10$ V
- $V_{BE(on)}$ @ -55°C, $V_{CE} = 10$ V

BF720T1G, BF720T3G

PACKAGE DIMENSIONS

SOT-223 (TO-261)
CASE 318E-04
ISSUE N

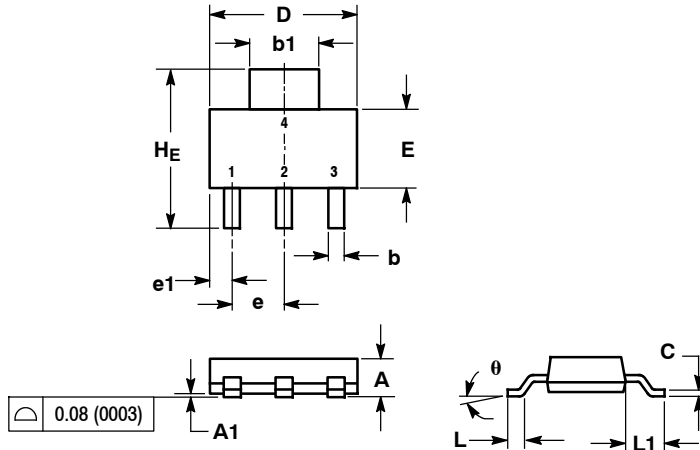

NOTES:
1. DIMENSIONING AND TOLERANCING PER ASME Y14.5M, 1994.
2. CONTROLLING DIMENSION: INCH.

DIM	MILLIMETERS			INCHES		
	MIN	NOM	MAX	MIN	NOM	MAX
A	1.50	1.63	1.75	0.060	0.064	0.068
A1	0.02	0.06	0.10	0.001	0.002	0.004
b	0.60	0.75	0.89	0.024	0.030	0.035
b1	2.90	3.06	3.20	0.115	0.121	0.126
c	0.24	0.29	0.35	0.009	0.012	0.014
D	6.30	6.50	6.70	0.249	0.256	0.263
E	3.30	3.50	3.70	0.130	0.138	0.145
e	2.20	2.30	2.40	0.087	0.091	0.094
e1	0.85	0.94	1.05	0.033	0.037	0.041
L	0.20	---	---	0.008	---	---
L1	1.50	1.75	2.00	0.060	0.069	0.078
HE	6.70	7.00	7.30	0.264	0.276	0.287
theta	0°	-	10°	0°	-	10°

STYLE 1:
PIN 1. BASE
2. COLLECTOR
3. EMITTER
4. COLLECTOR

SOLDERING FOOTPRINT*

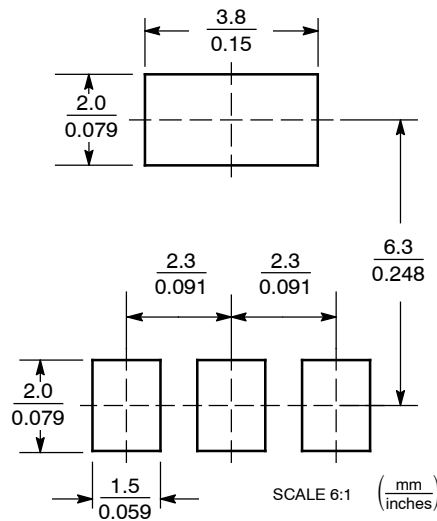

*For additional information on our Pb-Free strategy and soldering details, please download the ON Semiconductor Soldering and Mounting Techniques Reference Manual, SOLDERRM/D.

ON Semiconductor and are registered trademarks of Semiconductor Components Industries, LLC (SCILLC). SCILLC reserves the right to make changes without further notice to any products herein. SCILLC makes no warranty, representation or guarantee regarding the suitability of its products for any particular purpose, nor does SCILLC assume any liability arising out of the application or use of any product or circuit, and specifically disclaims any and all liability, including without limitation special, consequential or incidental damages. "Typical" parameters which may be provided in SCILLC data sheets and/or specifications can and do vary in different applications and actual performance may vary over time. All operating parameters, including "Typicals" must be validated for each customer application by customer's technical experts. SCILLC does not convey any license under its patent rights nor the rights of others. SCILLC products are not designed, intended, or authorized for use as components in systems intended for surgical implant into the body, or other applications intended to support or sustain life, or for any other application in which the failure of the SCILLC product could create a situation where personal injury or death may occur. Should Buyer purchase or use SCILLC products for any such unintended or unauthorized application, Buyer shall indemnify and hold SCILLC and its officers, employees, subsidiaries, affiliates, and distributors harmless against all claims, costs, damages, and expenses, and reasonable attorney fees arising out of, directly or indirectly, any claim of personal injury or death associated with such unintended or unauthorized use, even if such claim alleges that SCILLC was negligent regarding the design or manufacture of the part. SCILLC is an Equal Opportunity/Affirmative Action Employer. This literature is subject to all applicable copyright laws and is not for resale in any manner.

PUBLICATION ORDERING INFORMATION

LITERATURE FULFILLMENT:
Literature Distribution Center for ON Semiconductor
P.O. Box 5163, Denver, Colorado 80217 USA
Phone: 303-675-2175 or 800-344-3860 Toll Free USA/Canada
Fax: 303-675-2176 or 800-344-3867 Toll Free USA/Canada
Email: orderlit@onsemi.com

N. American Technical Support: 800-282-9855 Toll Free
USA/Canada
Europe, Middle East and Africa Technical Support:
Phone: 421 33 790 2910
Japan Customer Focus Center
Phone: 81-3-5773-3850

ON Semiconductor Website: www.onsemi.com
Order Literature: <http://www.onsemi.com/orderlit>
For additional information, please contact your local Sales Representative

BF720T1/D