

NSS12200WT1G

12 V, 3 A, Low $V_{CE(sat)}$ PNP Transistor

ON Semiconductor's e²PowerEdge family of low $V_{CE(sat)}$ transistors are miniature surface mount devices featuring ultra low saturation voltage ($V_{CE(sat)}$) and high current gain capability. These are designed for use in low voltage, high speed switching applications where affordable efficient energy control is important.

Typical application are DC-DC converters and power management in portable and battery powered products such as cellular and cordless phones, PDAs, computers, printers, digital cameras and MP3 players. Other applications are low voltage motor controls in mass storage products such as disc drives and tape drives. In the automotive industry they can be used in air bag deployment and in the instrument cluster. The high current gain allows e²PowerEdge devices to be driven directly from PMU's control outputs, and the Linear Gain (Beta) makes them ideal components in analog amplifiers.

Features

- High Current Capability (3 A)
- High Power Handling (Up to 650 mW)
- Low $V_{CE(s)}$ (170 mV Typical @ 1 A)
- Small Size
- These Devices are Pb-Free, Halogen Free/BFR Free and are RoHS Compliant

Benefits

- High Specific Current and Power Capability Reduces Required PCB Area
- Reduced Parasitic Losses Increases Battery Life

MAXIMUM RATINGS ($T_A = 25^\circ\text{C}$)

Rating	Symbol	Max	Unit
Collector-Emitter Voltage	V_{CEO}	-12	Vdc
Collector-Base Voltage	V_{CBO}	-12	Vdc
Emitter-Base Voltage	V_{EBO}	-5.0	Vdc
Collector Current – Continuous	I_C	-2.0	Adc
– Peak	I_{CM}	-3.0	
Electrostatic Discharge	ESD	HBM Class 3 MM Class C	

Stresses exceeding Maximum Ratings may damage the device. Maximum Ratings are stress ratings only. Functional operation above the Recommended Operating Conditions is not implied. Extended exposure to stresses above the Recommended Operating Conditions may affect device reliability.



ON Semiconductor®

<http://onsemi.com>

12 VOLTS
3.0 AMPS
PNP LOW $V_{CE(sat)}$ TRANSISTOR
EQUIVALENT $R_{DS(on)}$ 163 m Ω

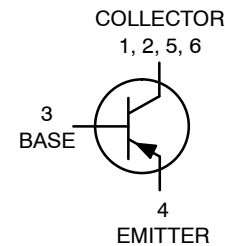

SC-88/SOT-363
CASE 419B
STYLE 20

DEVICE MARKING

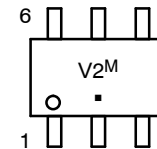

V2 = Specific Device Code
M = Date Code
▪ = Pb-Free Package

ORDERING INFORMATION

Device	Package	Shipping†
NSS12200WT1G	SOT-363 (Pb-Free)	3000 / Tape & Reel

†For information on tape and reel specifications, including part orientation and tape sizes, please refer to our Tape and Reel Packaging Specifications Brochure, BRD8011/D.

NSS12200WT1G

THERMAL CHARACTERISTICS

Characteristic	Symbol	Max	Unit
Total Device Dissipation $T_A = 25^\circ\text{C}$ Derate above 25°C	P_D (Note 1)	450	mW
		3.6	mW/ $^\circ\text{C}$
Thermal Resistance, Junction-to-Ambient	$R_{\theta JA}$ (Note 1)	275	$^\circ\text{C}/\text{W}$
Total Device Dissipation $T_A = 25^\circ\text{C}$ Derate above 25°C	P_D (Note 2)	650	mW
		5.2	mW/ $^\circ\text{C}$
Thermal Resistance, Junction-to-Ambient	$R_{\theta JA}$ (Note 2)	192	$^\circ\text{C}/\text{W}$
Thermal Resistance, Junction-to-Lead 6	$R_{\theta JL}$	105	$^\circ\text{C}/\text{W}$
Total Device Dissipation (Single Pulse < 10 sec.)	P_D Single	1.4	W
Junction and Storage Temperature Range	T_J, T_{stg}	-55 to +150	$^\circ\text{C}$

ELECTRICAL CHARACTERISTICS ($T_J = 25^\circ\text{C}$ unless otherwise noted)

Characteristic	Symbol	Min	Typ	Max	Unit
----------------	--------	-----	-----	-----	------

OFF CHARACTERISTICS

Collector-Emitter Breakdown Voltage, ($I_C = -10$ mAdc, $I_B = 0$)	$V_{(BR)CEO}$	-12	-15	-	Vdc
Collector-Base Breakdown Voltage, ($I_C = -0.1$ mAdc, $I_E = 0$)	$V_{(BR)CBO}$	-12	-25	-	Vdc
Emitter-Base Breakdown Voltage, ($I_E = -0.1$ mAdc, $I_C = 0$)	$V_{(BR)EBO}$	-5.0	-7.0	-	Vdc
Collector Cutoff Current, ($V_{CB} = -12$ Vdc, $I_E = 0$)	I_{CBO}	-	-0.02	-0.1	μAdc
Collector-Emitter Cutoff Current, ($V_{CES} = -12$ Vdc, $I_E = 0$)	I_{CES}	-	-0.03	-0.1	μAdc
Emitter Cutoff Current, ($V_{CES} = -5.0$ Vdc, $I_E = 0$)	I_{EBO}	-	-0.03	-0.1	μAdc

ON CHARACTERISTICS

DC Current Gain (Note 3) ($I_C = -0.5$ A, $V_{CE} = -1.5$ V) ($I_C = -0.8$ A, $V_{CE} = -1.5$ V) ($I_C = -1.0$ A, $V_{CE} = -1.5$ V)	h_{FE}	100 100 100	180 165 160	- 300 -	
Collector-Emitter Saturation Voltage (Note 3) ($I_C = -0.5$ A, $I_B = -10$ mA) ($I_C = -0.8$ A, $I_B = -16$ mA) ($I_C = -1.0$ A, $I_B = -20$ mA)	$V_{CE(sat)}$	- - -	-0.10 -0.14 -0.17	-0.160 -0.235 -0.290	V
Base-Emitter Saturation Voltage (Note 3) ($I_C = -1.0$ A, $I_B = -20$ mA)	$V_{BE(sat)}$	-	-0.84	-0.95	V
Base-Emitter Turn-on Voltage (Note 3) ($I_C = -1.0$ A, $V_{CE} = -1.5$ V)	$V_{BE(on)}$	-	-0.81	-0.95	V
Cutoff Frequency ($I_C = -100$ mA, $V_{CE} = -5.0$ V, $f = 100$ MHz)	f_T	-	100	-	MHz
Output Capacitance ($V_{CB} = -1.5$ V, $f = 1.0$ MHz)	C_{obo}	-	50	65	pF

- FR-4, Minimum Pad, 1 oz Coverage.
- FR-4, 1" Pad, 1 oz Coverage.
- Pulsed Condition: Pulse Width < 300 μsec , Duty Cycle < 2%.

NSS12200WT1G

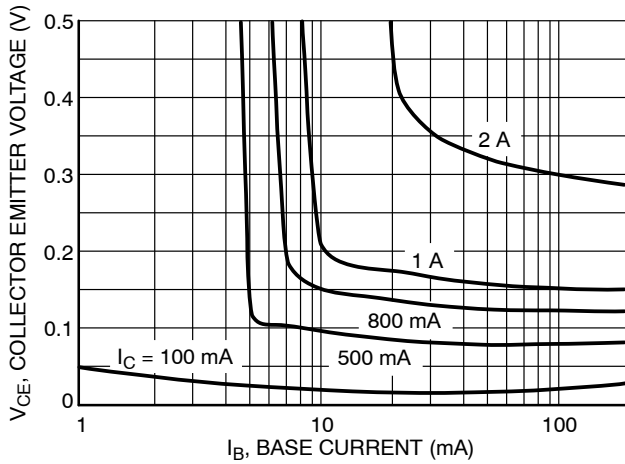

Figure 1. Collector Emitter Voltage vs. Base Current

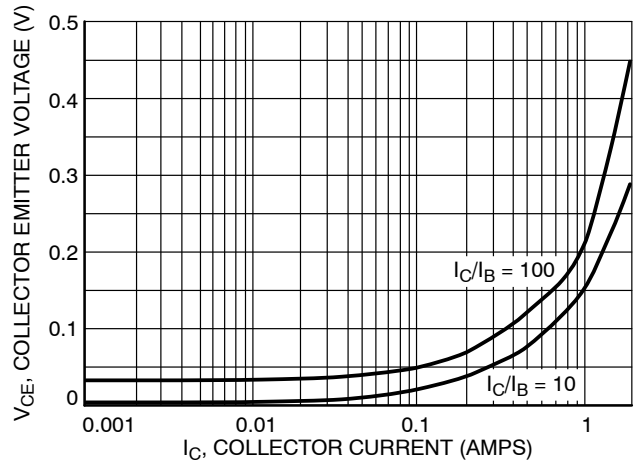

Figure 2. Collector Emitter Voltage vs. Collector Current

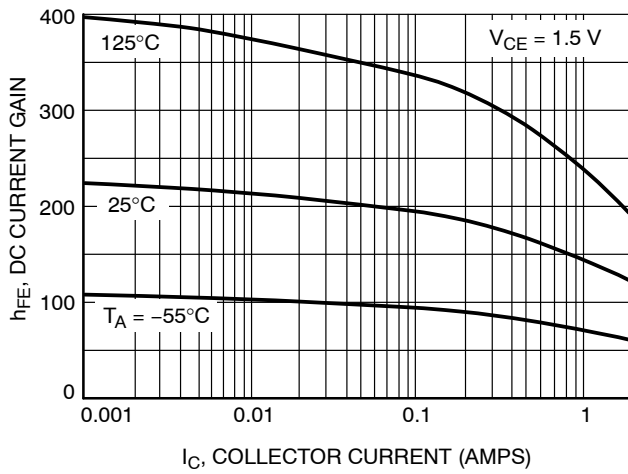

Figure 3. DC Current Gain vs. Collector Current

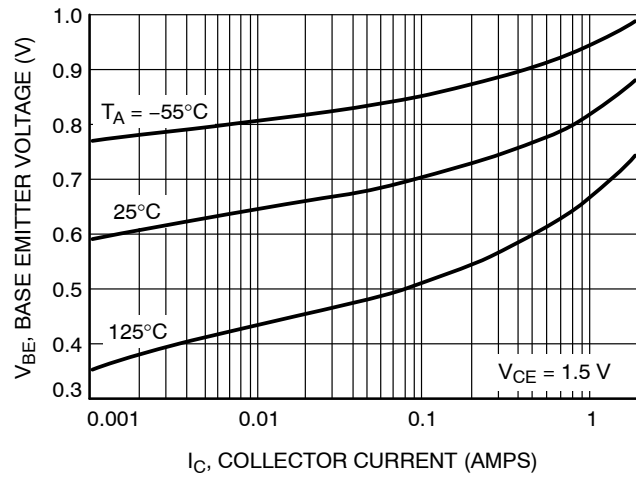

Figure 4. Base Emitter Voltage vs. Collector Current

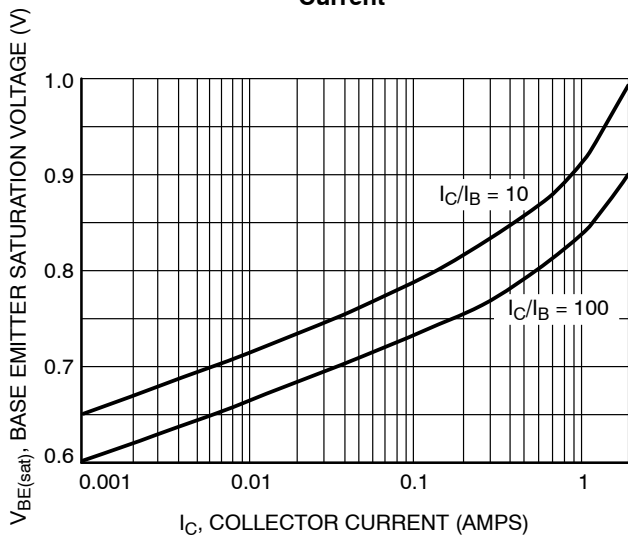

Figure 5. Base Emitter Saturation Voltage vs. Base Current

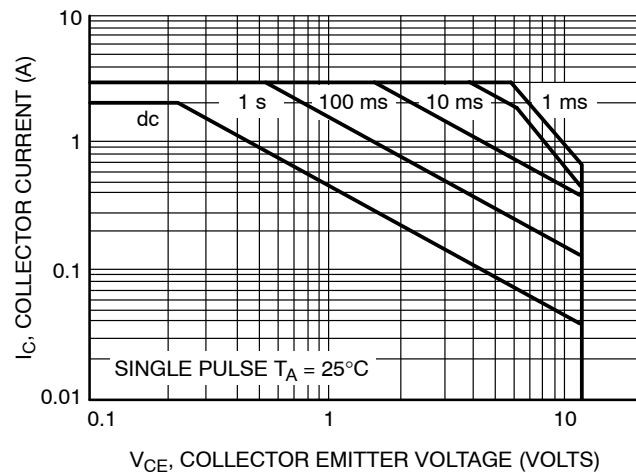

Figure 6. Safe Operating Area

NSS12200WT1G

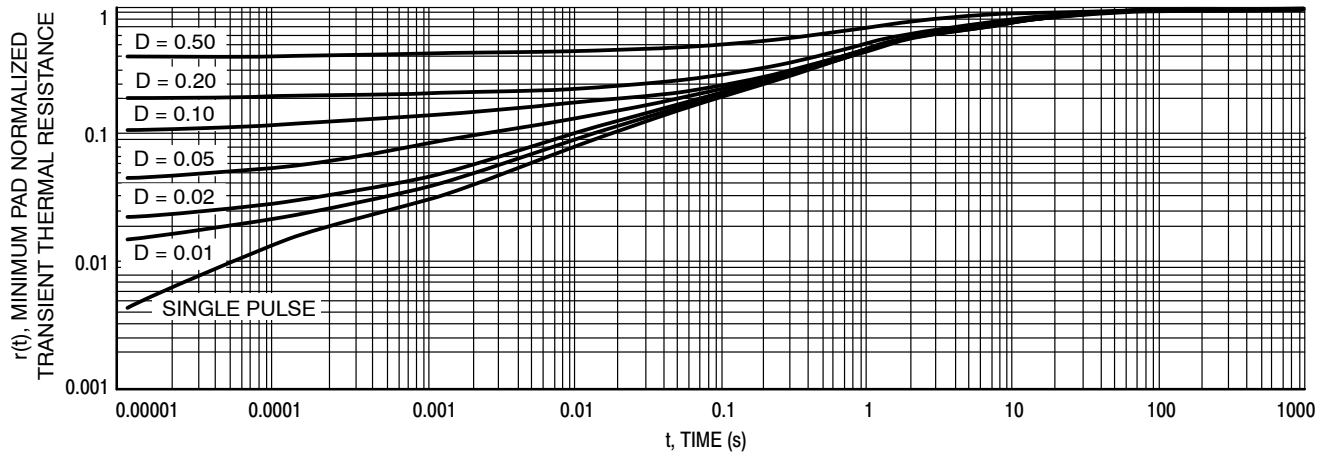

Figure 7. Normalized Thermal Response

NSS12200WT1G

PACKAGE DIMENSIONS

SC-88/SC70-6/SOT-363
CASE 419B-02
ISSUE W

NOTES:

1. DIMENSIONING AND TOLERANCING PER ANSI Y14.5M, 1982.
2. CONTROLLING DIMENSION: INCH.
3. 419B-01 OBSOLETE, NEW STANDARD 419B-02.

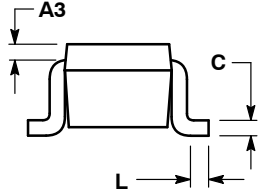
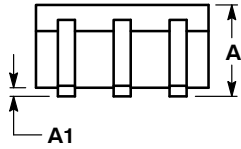
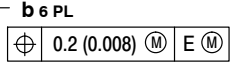
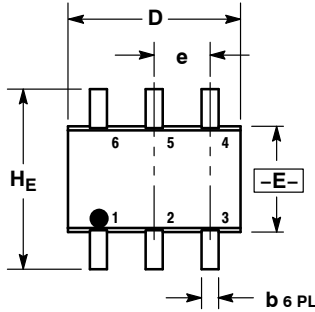

DIM	MILLIMETERS			INCHES		
	MIN	NOM	MAX	MIN	NOM	MAX
A	0.80	0.95	1.10	0.031	0.037	0.043
A1	0.00	0.05	0.10	0.000	0.002	0.004
A3	0.20 REF			0.008 REF		
b	0.10	0.21	0.30	0.004	0.008	0.012
C	0.10	0.14	0.25	0.004	0.005	0.010
D	1.80	2.00	2.20	0.070	0.078	0.086
E	1.15	1.25	1.35	0.045	0.049	0.053
e	0.65 BSC			0.026 BSC		
L	0.10	0.20	0.30	0.004	0.008	0.012
HE	2.00	2.10	2.20	0.078	0.082	0.086

STYLE 20:

- PIN 1. COLLECTOR
- 2. COLLECTOR
- 3. BASE
- 4. EMITTER
- 5. COLLECTOR
- 6. COLLECTOR

SOLDERING FOOTPRINT*

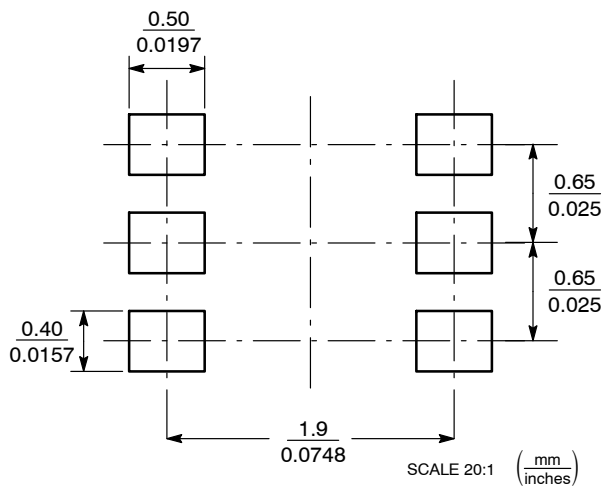

*For additional information on our Pb-Free strategy and soldering details, please download the ON Semiconductor Soldering and Mounting Techniques Reference Manual, SOLDERRM/D.

ON Semiconductor and are registered trademarks of Semiconductor Components Industries, LLC (SCILLC). SCILLC reserves the right to make changes without further notice to any products herein. SCILLC makes no warranty, representation or guarantee regarding the suitability of its products for any particular purpose, nor does SCILLC assume any liability arising out of the application or use of any product or circuit, and specifically disclaims any and all liability, including without limitation special, consequential or incidental damages. "Typical" parameters which may be provided in SCILLC data sheets and/or specifications can and do vary in different applications and actual performance may vary over time. All operating parameters, including "Typicals" must be validated for each customer application by customer's technical experts. SCILLC does not convey any license under its patent rights nor the rights of others. SCILLC products are not designed, intended, or authorized for use as components in systems intended for surgical implant into the body, or other applications intended to support or sustain life, or for any other application in which the failure of the SCILLC product could create a situation where personal injury or death may occur. Should Buyer purchase or use SCILLC products for any such unintended or unauthorized application, Buyer shall indemnify and hold SCILLC and its officers, employees, subsidiaries, affiliates, and distributors harmless against all claims, costs, damages, and expenses, and reasonable attorney fees arising out of, directly or indirectly, any claim of personal injury or death associated with such unintended or unauthorized use, even if such claim alleges that SCILLC was negligent regarding the design or manufacture of the part. SCILLC is an Equal Opportunity/Affirmative Action Employer. This literature is subject to all applicable copyright laws and is not for resale in any manner.

PUBLICATION ORDERING INFORMATION

LITERATURE FULFILLMENT:
Literature Distribution Center for ON Semiconductor
P.O. Box 5163, Denver, Colorado 80217 USA
Phone: 303-675-2175 or 800-344-3860 Toll Free USA/Canada
Fax: 303-675-2176 or 800-344-3867 Toll Free USA/Canada
Email: orderlit@onsemi.com

N. American Technical Support: 800-282-9855 Toll Free USA/Canada
Europe, Middle East and Africa Technical Support:
Phone: 421 33 790 2910
Japan Customer Focus Center
Phone: 81-3-5773-3850

ON Semiconductor Website: www.onsemi.com
Order Literature: <http://www.onsemi.com/orderlit>
For additional information, please contact your local Sales Representative

NSS12200W/D