

NPN - 2N6515, 2N6517; PNP - 2N6520

High Voltage Transistors NPN and PNP

Features

- Voltage and Current are Negative for PNP Transistors
- These are Pb-Free Devices*

MAXIMUM RATINGS

Rating	Symbol	Value	Unit
Collector – Emitter Voltage 2N6515 2N6517, 2N6520	V_{CEO}	250 350	Vdc
Collector – Base Voltage 2N6515 2N6517, 2N6520	V_{CBO}	250 350	Vdc
Emitter – Base Voltage 2N6515, 2N6517 2N6520	V_{EBO}	6.0 5.0	Vdc
Base Current	I_B	250	mAdc
Collector Current – Continuous	I_C	500	mAdc
Total Device Dissipation @ $T_A = 25^\circ\text{C}$ Derate above 25°C	P_D	625 5.0	mW mW/ $^\circ\text{C}$
Total Device Dissipation @ $T_C = 25^\circ\text{C}$ Derate above 25°C	P_D	1.5 12	W mW/ $^\circ\text{C}$
Operating and Storage Junction Temperature Range	T_J, T_{stg}	-55 to +150	$^\circ\text{C}$

THERMAL CHARACTERISTICS

Characteristic	Symbol	Max	Unit
Thermal Resistance, Junction-to-Ambient	$R_{\theta JA}$	200	$^\circ\text{C}/\text{W}$
Thermal Resistance, Junction-to-Case	$R_{\theta JC}$	83.3	$^\circ\text{C}/\text{W}$

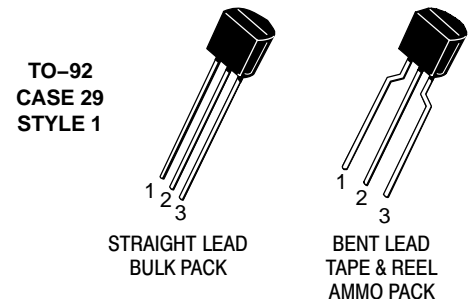
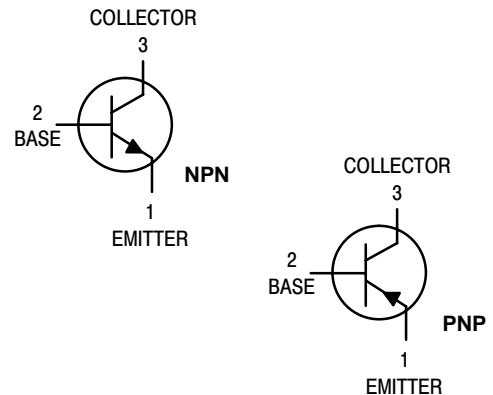
Stresses exceeding Maximum Ratings may damage the device. Maximum Ratings are stress ratings only. Functional operation above the Recommended Operating Conditions is not implied. Extended exposure to stresses above the Recommended Operating Conditions may affect device reliability.

*For additional information on our Pb-Free strategy and soldering details, please download the ON Semiconductor Soldering and Mounting Techniques Reference Manual, SOLDERRM/D.

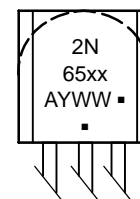


ON Semiconductor®

<http://onsemi.com>



MARKING DIAGRAM



xx = 15, 17, or 20
A = Assembly Location
Y = Year
WW = Work Week
▪ = Pb-Free Package

(Note: Microdot may be in either location)

ORDERING INFORMATION

See detailed ordering and shipping information in the package dimensions section on page 6 of this data sheet.

NPN – 2N6515, 2N6517; PNP – 2N6520

ELECTRICAL CHARACTERISTICS (T_A = 25°C unless otherwise noted)

Characteristic	Symbol	Min	Max	Unit	
OFF CHARACTERISTICS					
Collector–Emitter Breakdown Voltage (Note 1) (I _C = 1.0 mA _{dc} , I _B = 0)	2N6515 2N6517, 2N6520	V _{(BR)CEO}	250 350	– –	V _{dc}
Collector–Base Breakdown Voltage (I _C = 100 μA _{dc} , I _E = 0)	2N6515 2N6517, 2N6520	V _{(BR)CBO}	250 350	– –	V _{dc}
Emitter–Base Breakdown Voltage (I _E = 10 μA _{dc} , I _C = 0)	2N6515, 2N6517 2N6520	V _{(BR)EBO}	6.0 5.0	– –	V _{dc}
Collector Cutoff Current (V _{CB} = 150 V _{dc} , I _E = 0) (V _{CB} = 250 V _{dc} , I _E = 0)	2N6515 2N6517, 2N6520	I _{CBO}	– –	50 50	nA _{dc}
Emitter Cutoff Current (V _{EB} = 5.0 V _{dc} , I _C = 0) (V _{EB} = 4.0 V _{dc} , I _C = 0)	2N6515, 2N6517 2N6520	I _{EBO}	– –	50 50	nA _{dc}

ON CHARACTERISTICS (Note 1)

DC Current Gain (I _C = 1.0 mA _{dc} , V _{CE} = 10 V _{dc})	2N6515 2N6517, 2N6520	h _{FE}	35 20	– –	–
(I _C = 10 mA _{dc} , V _{CE} = 10 V _{dc})	2N6515 2N6517, 2N6520		50 30	– –	
(I _C = 30 mA _{dc} , V _{CE} = 10 V _{dc})	2N6515 2N6517, 2N6520		50 30	300 200	
(I _C = 50 mA _{dc} , V _{CE} = 10 V _{dc})	2N6515 2N6517, 2N6520		45 20	220 200	
(I _C = 100 mA _{dc} , V _{CE} = 10 V _{dc})	2N6515 2N6517, 2N6520		25 15	– –	
Collector–Emitter Saturation Voltage (I _C = 10 mA _{dc} , I _B = 1.0 mA _{dc}) (I _C = 20 mA _{dc} , I _B = 2.0 mA _{dc}) (I _C = 30 mA _{dc} , I _B = 3.0 mA _{dc}) (I _C = 50 mA _{dc} , I _B = 5.0 mA _{dc})		V _{CE(sat)}	– – – –	0.30 0.35 0.50 1.0	V _{dc}
Base–Emitter Saturation Voltage (I _C = 10 mA _{dc} , I _B = 1.0 mA _{dc}) (I _C = 20 mA _{dc} , I _B = 2.0 mA _{dc}) (I _C = 30 mA _{dc} , I _B = 3.0 mA _{dc})		V _{BE(sat)}	– – –	0.75 0.85 0.90	V _{dc}
Base–Emitter On Voltage (I _C = 100 mA _{dc} , V _{CE} = 10 V _{dc})		V _{BE(on)}	–	2.0	V _{dc}

SMALL-SIGNAL CHARACTERISTICS

Current–Gain – Bandwidth Product (Note 1) (I _C = 10 mA _{dc} , V _{CE} = 20 V _{dc} , f = 20 MHz)		f _T	40	200	MHz
Collector–Base Capacitance (V _{CB} = 20 V _{dc} , I _E = 0, f = 1.0 MHz)		C _{cb}	–	6.0	pF
Emitter–Base Capacitance (V _{EB} = 0.5 V _{dc} , I _C = 0, f = 1.0 MHz)	2N6515, 2N6517 2N6520	C _{eb}	– –	80 100	pF

SWITCHING CHARACTERISTICS

Turn–On Time (V _{CC} = 100 V _{dc} , V _{BE(off)} = 2.0 V _{dc} , I _C = 50 mA _{dc} , I _{B1} = 10 mA _{dc})		t _{on}	–	200	μs
Turn–Off Time (V _{CC} = 100 V _{dc} , I _C = 50 mA _{dc} , I _{B1} = I _{B2} = 10 mA _{dc})		t _{off}	–	3.5	μs

1. Pulse Test: Pulse Width ≤ 300 μs, Duty Cycle ≤ 2.0%.

NPN – 2N6515, 2N6517; PNP – 2N6520

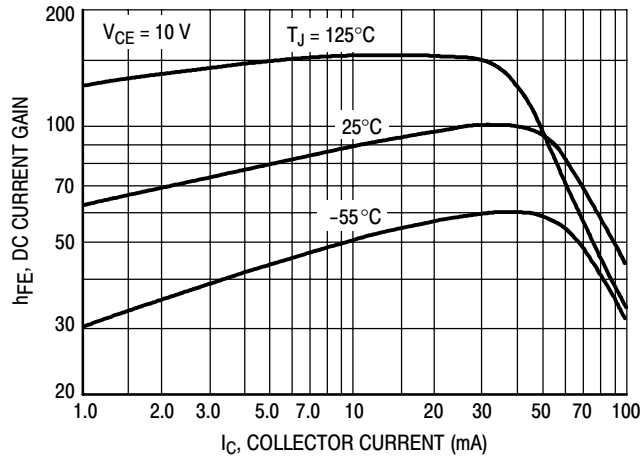


Figure 1. DC Current Gain
NPN 2N6515

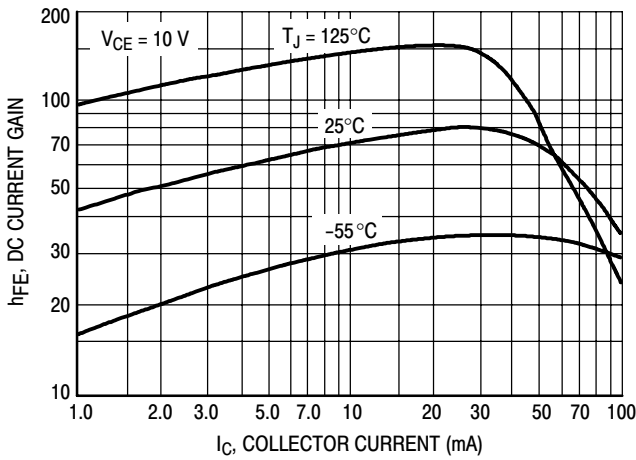


Figure 2. DC Current Gain
NPN 2N6517

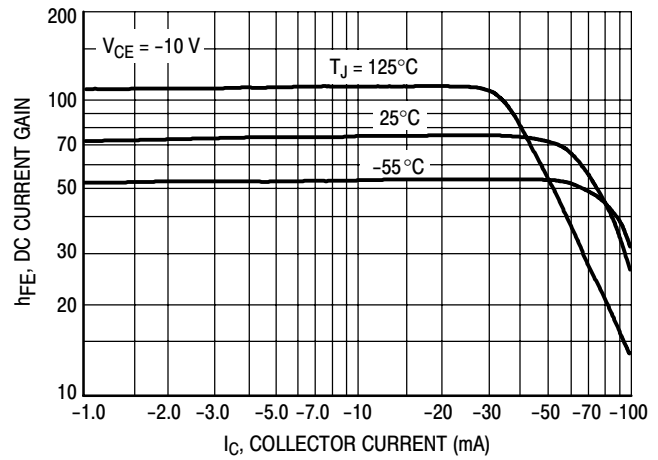


Figure 3. DC Current Gain
PNP 2N6520

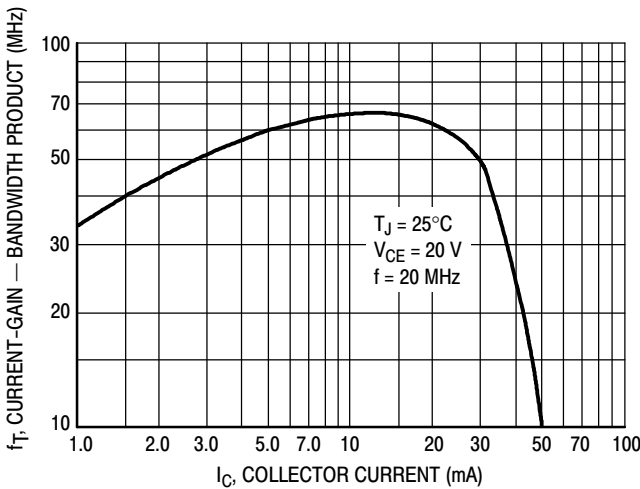


Figure 4. Current-Gain – Bandwidth Product
NPN 2N6515, 2N6517

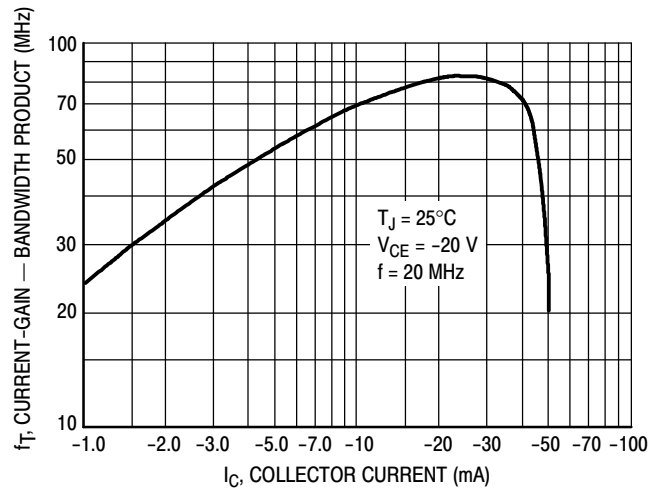
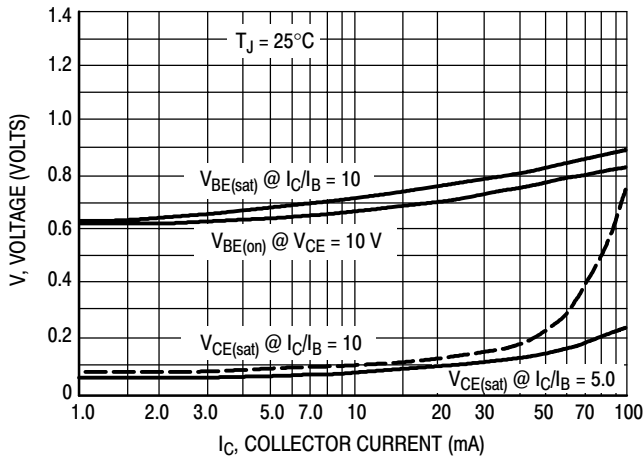
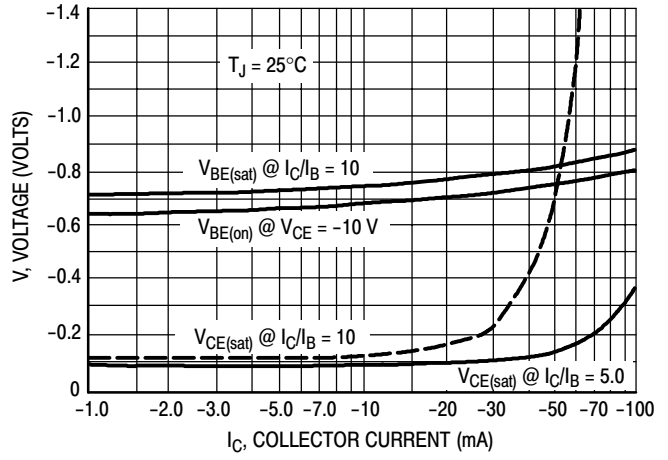


Figure 5. Current-Gain – Bandwidth Product
PNP 2N6520

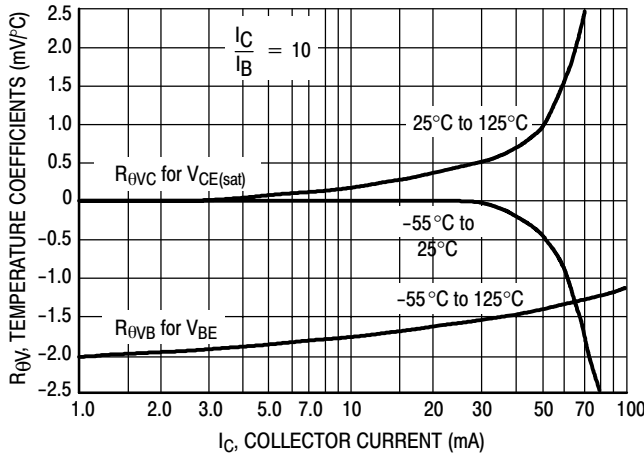
NPN – 2N6515, 2N6517; PNP – 2N6520



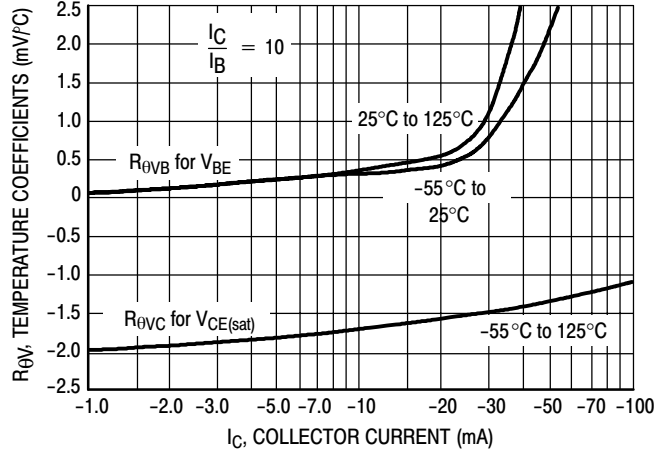
**Figure 6. "On" Voltages
NPN 2N6515, 2N6517**



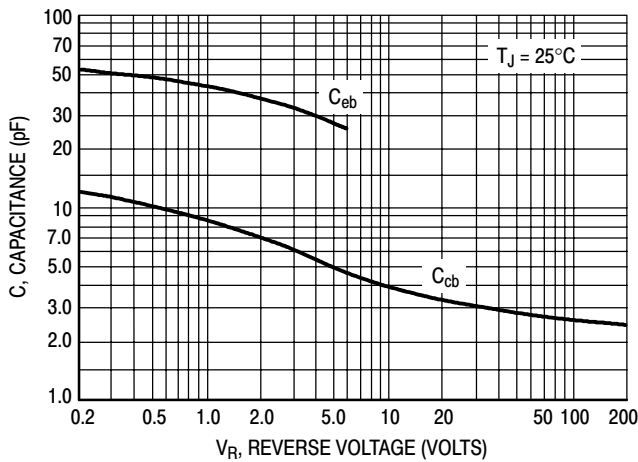
**Figure 7. "On" Voltages
PNP 2N6520**



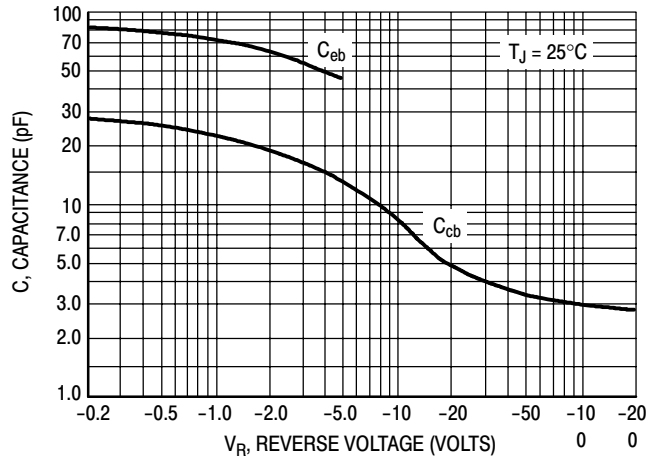
**Figure 8. Temperature Coefficients
NPN 2N6515, 2N6517**



**Figure 9. Temperature Coefficients
PNP 2N6520**

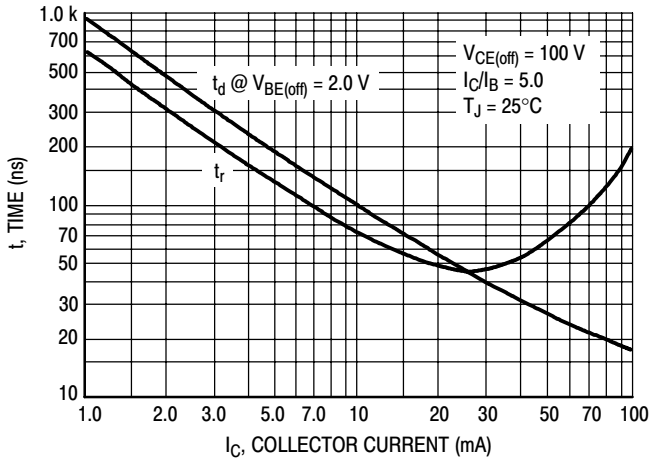


**Figure 10. Capacitance
NPN 2N6515, 2N6517**

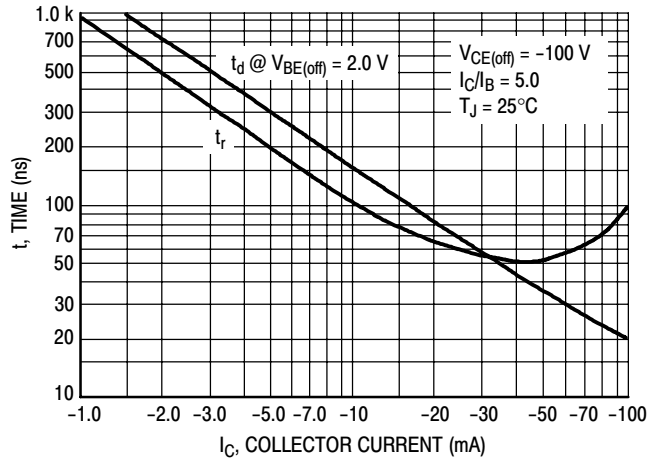


**Figure 11. Capacitance
PNP 2N6520**

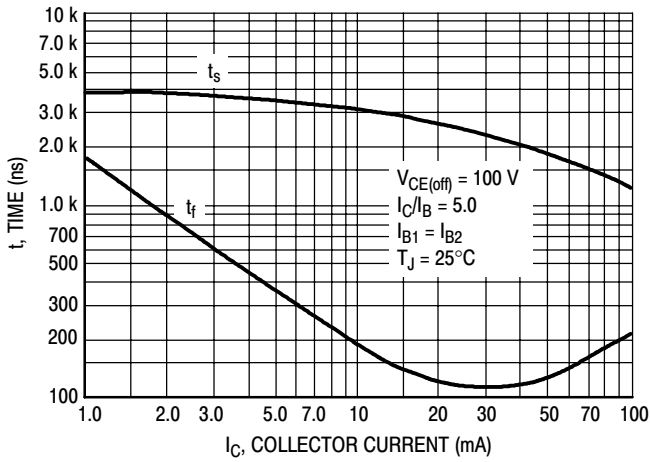
NPN – 2N6515, 2N6517; PNP – 2N6520



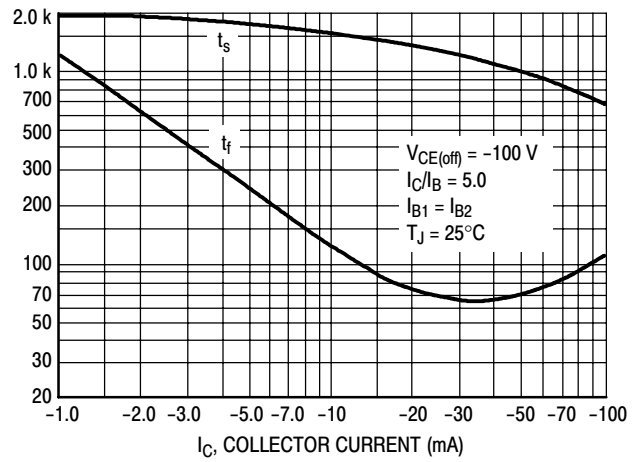
**Figure 12. Turn-On Time
NPN 2N6515, 2N6517**



**Figure 13. Turn-On Time
PNP 2N6520**



**Figure 14. Turn-Off Time
NPN 2N6515, 2N6517**



**Figure 15. Turn-Off Time
PNP 2N6520**

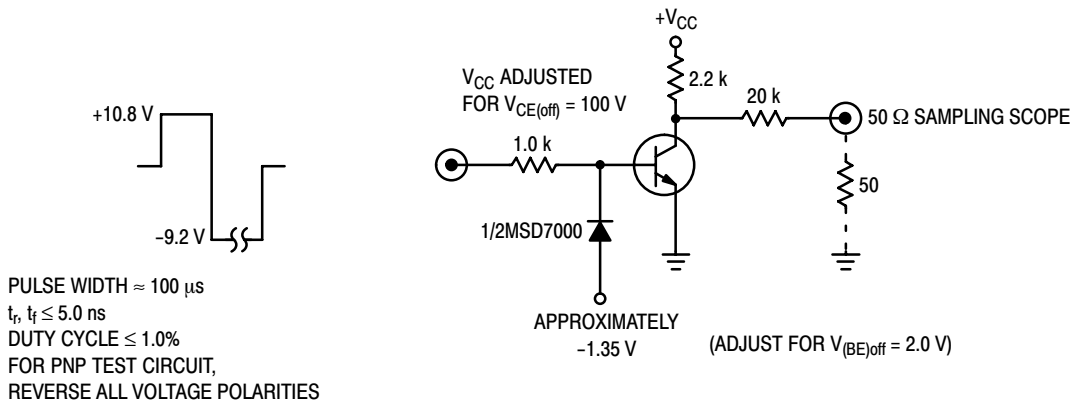
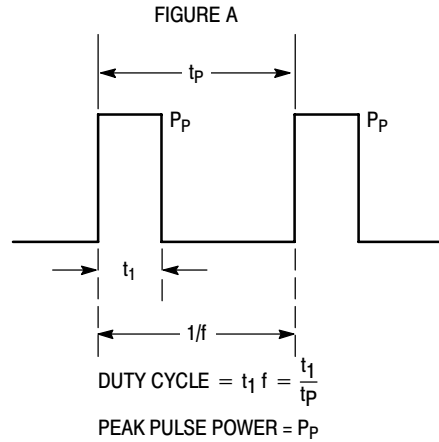
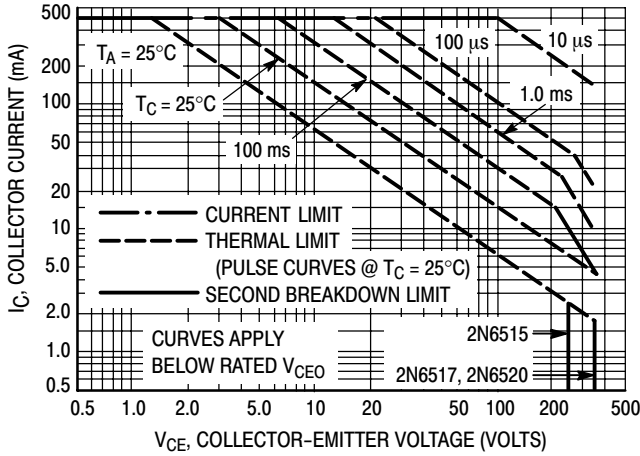
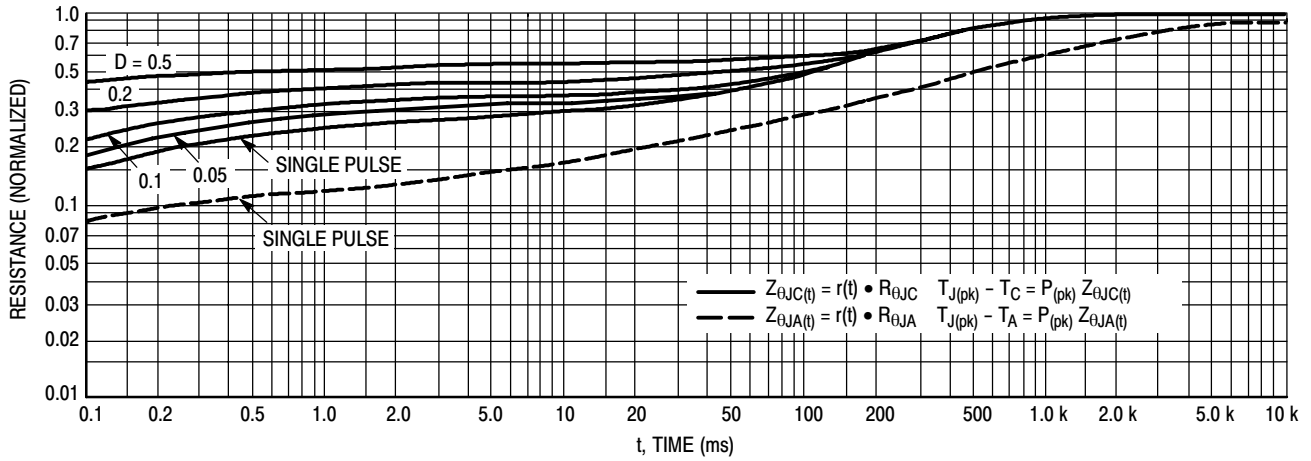


Figure 16. Switching Time Test Circuit

NPN – 2N6515, 2N6517; PNP – 2N6520



ORDERING INFORMATION

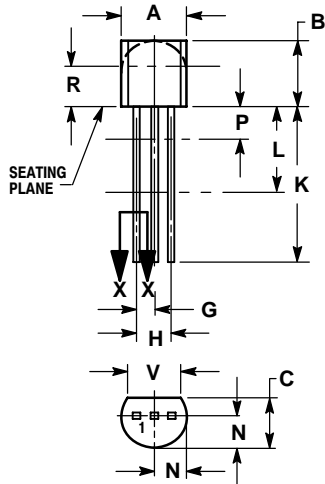
Device	Package	Shipping†
2N6515RLRMG	TO-92 (Pb-Free)	2000 Ammo Pack
2N6517G	TO-92 (Pb-Free)	5000 Unit / Bulk
2N6517RLRPG	TO-92 (Pb-Free)	2000 Ammo Pack
2N6520RLRAG	TO-92 (Pb-Free)	2000 Tape & Reel

†For information on tape and reel specifications, including part orientation and tape sizes, please refer to our Tape and Reel Packaging Specifications Brochure, BRD8011/D.

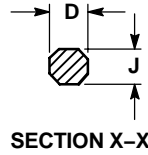
NPN – 2N6515, 2N6517; PNP – 2N6520

PACKAGE DIMENSIONS

TO-92 (TO-226)
CASE 29-11
ISSUE AM



STRAIGHT LEAD
BULK PACK

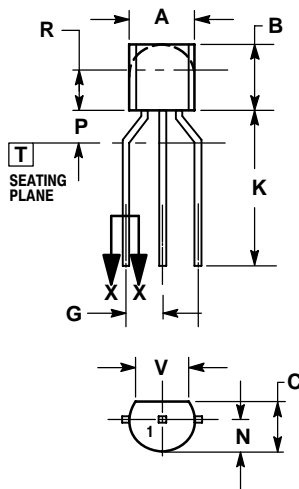


SECTION X-X

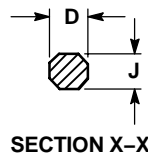
NOTES:

1. DIMENSIONING AND TOLERANCING PER ANSI Y14.5M, 1982.
2. CONTROLLING DIMENSION: INCH.
3. CONTOUR OF PACKAGE BEYOND DIMENSION R IS UNCONTROLLED.
4. LEAD DIMENSION IS UNCONTROLLED IN P AND BEYOND DIMENSION K MINIMUM.

DIM	INCHES		MILLIMETERS	
	MIN	MAX	MIN	MAX
A	0.175	0.205	4.45	5.20
B	0.170	0.210	4.32	5.33
C	0.125	0.165	3.18	4.19
D	0.016	0.021	0.407	0.533
G	0.045	0.055	1.15	1.39
H	0.095	0.105	2.42	2.66
J	0.015	0.020	0.39	0.50
K	0.500	---	12.70	---
L	0.250	---	6.35	---
N	0.080	0.105	2.04	2.66
P	---	0.100	---	2.54
R	0.115	---	2.93	---
V	0.135	---	3.43	---



BENT LEAD
TAPE & REEL
AMMO PACK



SECTION X-X


NOTES:

1. DIMENSIONING AND TOLERANCING PER ASME Y14.5M, 1994.
2. CONTROLLING DIMENSION: MILLIMETERS.
3. CONTOUR OF PACKAGE BEYOND DIMENSION R IS UNCONTROLLED.
4. LEAD DIMENSION IS UNCONTROLLED IN P AND BEYOND DIMENSION K MINIMUM.

DIM	MILLIMETERS	
	MIN	MAX
A	4.45	5.20
B	4.32	5.33
C	3.18	4.19
D	0.40	0.54
G	2.40	2.80
J	0.39	0.50
K	12.70	---
N	2.04	2.66
P	1.50	4.00
R	2.93	---
V	3.43	---

STYLE 1:

1. PIN 1. EMITTER
2. BASE
3. COLLECTOR

ON Semiconductor and  are registered trademarks of Semiconductor Components Industries, LLC (SCILLC). SCILLC reserves the right to make changes without further notice to any products herein. SCILLC makes no warranty, representation or guarantee regarding the suitability of its products for any particular purpose, nor does SCILLC assume any liability arising out of the application or use of any product or circuit, and specifically disclaims any and all liability, including without limitation special, consequential or incidental damages. "Typical" parameters which may be provided in SCILLC data sheets and/or specifications can and do vary in different applications and actual performance may vary over time. All operating parameters, including "Typicals" must be validated for each customer application by customer's technical experts. SCILLC does not convey any license under its patent rights nor the rights of others. SCILLC products are not designed, intended, or authorized for use as components in systems intended for surgical implant into the body, or other applications intended to support or sustain life, or for any other application in which the failure of the SCILLC product could create a situation where personal injury or death may occur. Should Buyer purchase or use SCILLC products for any such unintended or unauthorized application, Buyer shall indemnify and hold SCILLC and its officers, employees, subsidiaries, affiliates, and distributors harmless against all claims, costs, damages, and expenses, and reasonable attorney fees arising out of, directly or indirectly, any claim of personal injury or death associated with such unintended or unauthorized use, even if such claim alleges that SCILLC was negligent regarding the design or manufacture of the part. SCILLC is an Equal Opportunity/Affirmative Action Employer. This literature is subject to all applicable copyright laws and is not for resale in any manner.

PUBLICATION ORDERING INFORMATION

LITERATURE FULFILLMENT:
Literature Distribution Center for ON Semiconductor
P.O. Box 5163, Denver, Colorado 80217 USA
Phone: 303-675-2175 or 800-344-3860 Toll Free USA/Canada
Fax: 303-675-2176 or 800-344-3867 Toll Free USA/Canada
Email: orderlit@onsemi.com

N. American Technical Support: 800-282-9855 Toll Free
USA/Canada
Europe, Middle East and Africa Technical Support:
Phone: 421 33 790 2910
Japan Customer Focus Center
Phone: 81-3-5773-3850

ON Semiconductor Website: www.onsemi.com

Order Literature: <http://www.onsemi.com/orderlit>

For additional information, please contact your local Sales Representative

2N6515/D