



ZXTP749F

PNP LOW $V_{CE(sat)}$ TRANSISTOR IN SOT-23

Features

- $BV_{CEO} > -25V$
- $BV_{CBO} > -35V$
- $I_{C(cont)} = -3A$ Continuous Current
- $V_{CE(sat)} < -150mV @ -1A$
- $R_{CE(sat)} = 87 m\Omega$
- $P_D = 0.725W$
- -6A Peak Pulse Current
- -25V Forward Blocking Voltage
- Complementary part number ZXTN649F
- **Lead, Halogen and Antimony Free, RoHS Compliant (Note 1)**
- **“Green” Device (Note 2)**

Mechanical Data

- Case: SOT-23
- Case Material: Molded Plastic. “Green” Molding Compound.
- UL Flammability Rating 94V-0
- Moisture Sensitivity: Level 1 per J-STD-020
- Terminals: Matte Tin Finish
- Weight: 0.008 grams (approximate)

Applications

- MOSFET gate drivers
- Power switches
- Motor control

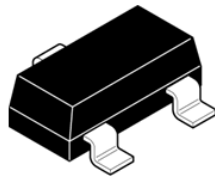

Top View

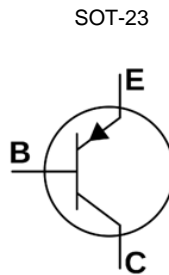

Device symbol

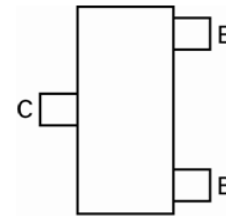

Pin Configuration

Ordering Information

Product	Marking	Reel size (inches)	Tape width (mm)	Quantity per reel
ZXTP749FTA	1N8	7	8mm	3000

- Notes:
1. No purposefully added lead. Halogen and Antimony Free.
 2. Diodes Inc.'s “Green” Policy can be found on our website at <http://www.diodes.com>

Marking Information

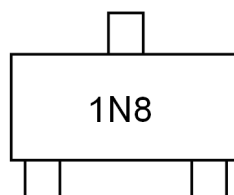

1N8 = Product type Marking Code

ZXTP749F

PNP LOW $V_{CE(sat)}$ TRANSISTOR IN SOT-23

Maximum Ratings @ $T_A = 25^\circ\text{C}$ unless otherwise specified

Characteristic	Symbol	Value	Unit
Collector-Base Voltage	V_{CBO}	35	V
Collector-Emitter Voltage	V_{CEO}	25	V
Emitter-Base Voltage	V_{EBO}	7	V
Continuous Collector Current (Note 4)	I_C	3	A
Peak Pulse Current	I_{CM}	6	A
Base Current	I_B	500	mA

Thermal Characteristics

Characteristic	Symbol	Value	Unit
Power Dissipation at $T_A = 25^\circ\text{C}$ (Note 3)	P_D	725	mW
Thermal Resistance, Junction to Ambient (Note 3) @ $T_A = 25^\circ\text{C}$	$R_{\theta JA}$	172	$^\circ\text{C}/\text{W}$
Thermal Resistance, Junction to Lead @ $T_A = 25^\circ\text{C}$	$R_{\theta JL}$	79	$^\circ\text{C}/\text{W}$
Operating and Storage Temperature Range	T_J, T_{STG}	-55 to +150	$^\circ\text{C}$

- Notes:
3. For a device surface mounted on 15mm X 15mm X 1.6mm FR4 PCB with high coverage of single sided 1 oz copper, in still air conditions
 4. For device mounted on FR4 PCB measured at $t \leq 2$ Secs.

Thermal Characteristics and Derating information

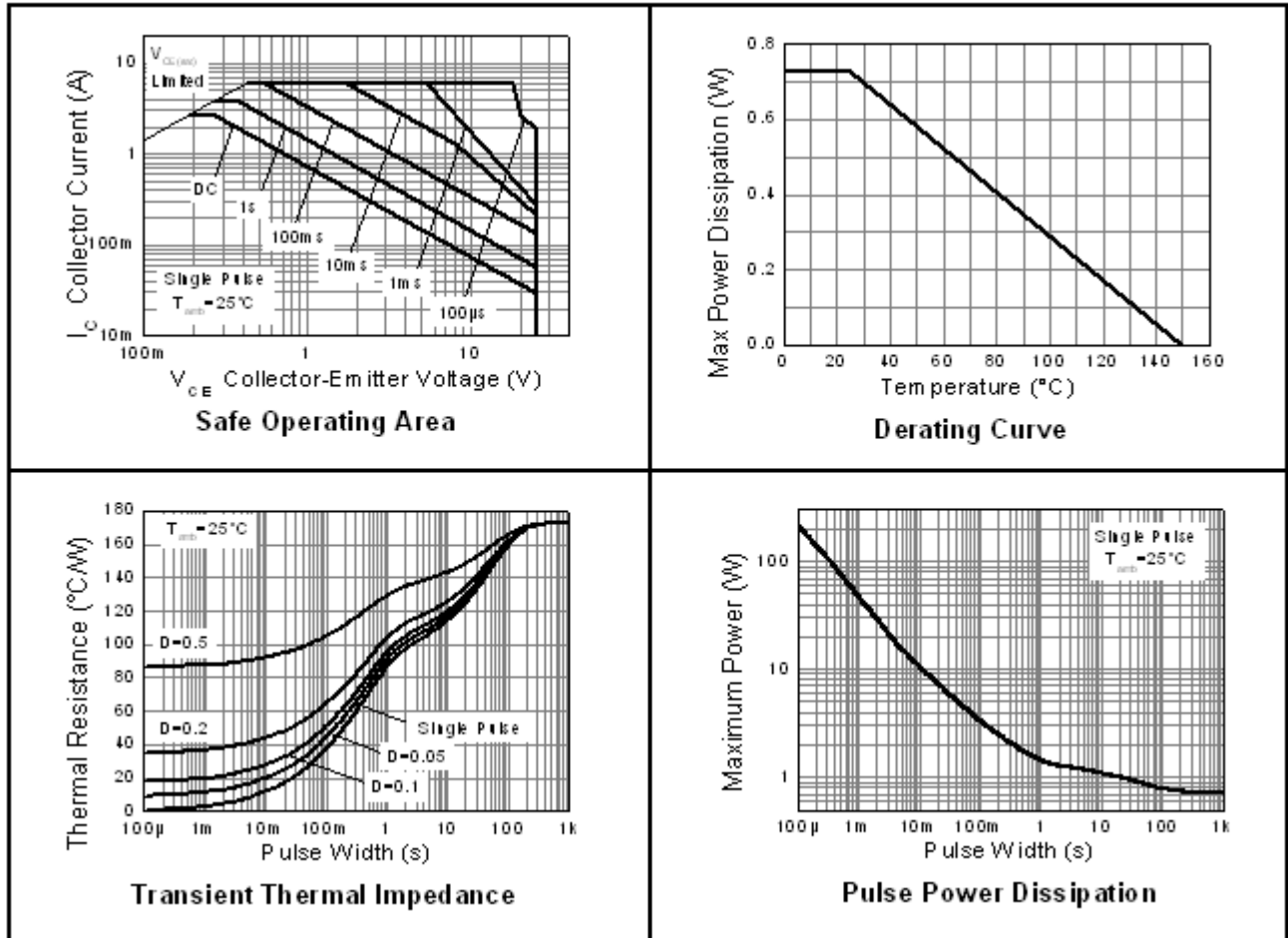

PNP LOW $V_{CE(sat)}$ TRANSISTOR IN SOT-23

Electrical Characteristics @ $T_A = 25^\circ\text{C}$ unless otherwise specified

Characteristic	Symbol	Min	Typ	Max	Unit	Test Condition
Collector-Base Breakdown Voltage	$V_{(BR)CBO}$	-35	60		V	$I_C = -100 \mu\text{A}$
Collector-Emitter Breakdown Voltage (Note 5)	$V_{(BR)CEO}$	-25	40		V	$I_C = -10 \text{mA}$
Emitter-Base Breakdown Voltage	$V_{(BR)EBO}$	-7	8.4		V	$I_E = 100 \mu\text{A}$
Collector Cutoff Current	I_{CBO}		< 1	-50 -0.5	nA μA	$V_{CB} = -28\text{V}$ $V_{CB} = -28\text{V}, T_{amb} = 100^\circ\text{C}$
Emitter Cutoff Current	I_{EBO}		< 1	-50	nA	$V_{EB} = -5.6\text{V}$
Static Forward Current Transfer Ratio (Note 5)	h_{FE}	200 130 100 25	320 230 180 50	500		$I_C = -100\text{mA}, V_{CE} = -2\text{V}$ $I_C = -1\text{A}, V_{CE} = -2\text{V}$ $I_C = -2\text{A}, V_{CE} = -2\text{V}$ $I_C = -6\text{A}, V_{CE} = -2\text{V}$
Collector-Emitter Saturation Voltage (Note 5)	$V_{CE(sat)}$		-85 -229	-150 -350	mV mV	$I_C = -1\text{A}, I_B = -100\text{mV}$ $I_C = -3\text{A}, I_B = -300\text{mV}$
Base-Emitter Turn-On Voltage (Note 5)	$V_{BE(on)}$		-786	-850	mV	$I_C = -1\text{A}, V_{CE} = -2\text{V}$
Base-Emitter Saturation Voltage (Note 5)	$V_{BE(sat)}$		-895	-1000	mV	$I_C = -1\text{A}, I_B = -100\text{mV}$

Notes: 5. Measured under pulsed conditions. Pulse width $\leq 300 \mu\text{s}$. Duty cycle $\leq 2\%$

Typical Characteristics

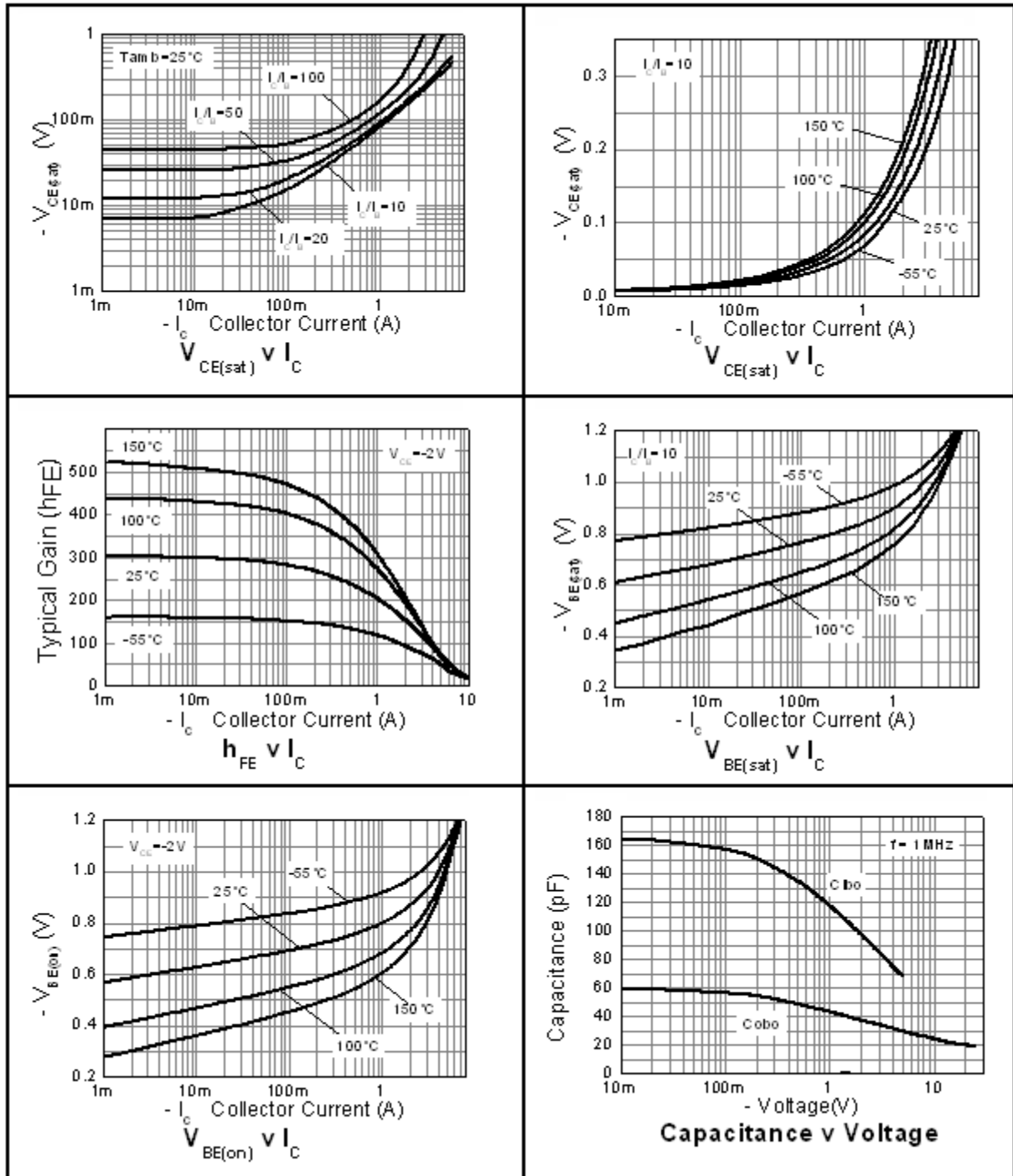

ZXTP749F

PNP LOW $V_{CE(sat)}$ TRANSISTOR IN SOT-23

Package Outline Dimensions

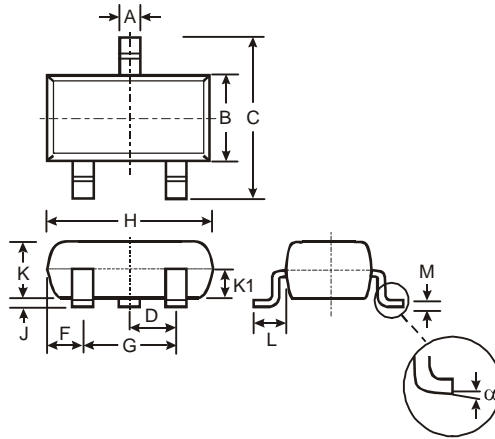

SOT-23			
Dim	Min	Max	Typ
A	0.37	0.51	0.40
B	1.20	1.40	1.30
C	2.30	2.50	2.40
D	0.89	1.03	0.915
F	0.45	0.60	0.535
G	1.78	2.05	1.83
H	2.80	3.00	2.90
J	0.013	0.10	0.05
K	0.903	1.10	1.00
K1	-	-	0.400
L	0.45	0.61	0.55
M	0.085	0.18	0.11
α	0°	8°	-
All Dimensions in mm			

Suggested Pad Layout

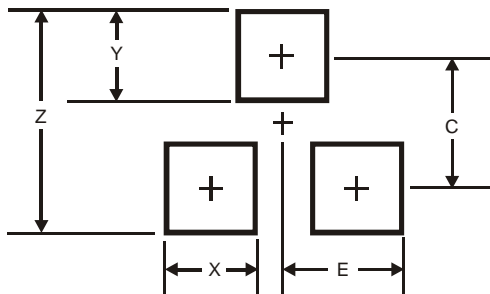

Dimensions	Value (in mm)
Z	2.9
X	0.8
Y	0.9
C	2.0
E	1.35

ZXTP749F**PNP LOW $V_{CE(sat)}$ TRANSISTOR IN SOT-23****IMPORTANT NOTICE**

DIODES INCORPORATED MAKES NO WARRANTY OF ANY KIND, EXPRESS OR IMPLIED, WITH REGARDS TO THIS DOCUMENT, INCLUDING, BUT NOT LIMITED TO, THE IMPLIED WARRANTIES OF MERCHANTABILITY AND FITNESS FOR A PARTICULAR PURPOSE (AND THEIR EQUIVALENTS UNDER THE LAWS OF ANY JURISDICTION).

Diodes Incorporated and its subsidiaries reserve the right to make modifications, enhancements, improvements, corrections or other changes without further notice to this document and any product described herein. Diodes Incorporated does not assume any liability arising out of the application or use of this document or any product described herein; neither does Diodes Incorporated convey any license under its patent or trademark rights, nor the rights of others. Any Customer or user of this document or products described herein in such applications shall assume all risks of such use and will agree to hold Diodes Incorporated and all the companies whose products are represented on Diodes Incorporated website, harmless against all damages.

Diodes Incorporated does not warrant or accept any liability whatsoever in respect of any products purchased through unauthorized sales channel. Should Customers purchase or use Diodes Incorporated products for any unintended or unauthorized application, Customers shall indemnify and hold Diodes Incorporated and its representatives harmless against all claims, damages, expenses, and attorney fees arising out of, directly or indirectly, any claim of personal injury or death associated with such unintended or unauthorized application.

Products described herein may be covered by one or more United States, international or foreign patents pending. Product names and markings noted herein may also be covered by one or more United States, international or foreign trademarks.

LIFE SUPPORT

Diodes Incorporated products are specifically not authorized for use as critical components in life support devices or systems without the express written approval of the Chief Executive Officer of Diodes Incorporated. As used herein:

- A. Life support devices or systems are devices or systems which:
1. are intended to implant into the body, or
 2. support or sustain life and whose failure to perform when properly used in accordance with instructions for use provided in the labeling can be reasonably expected to result in significant injury to the user.
- B. A critical component is any component in a life support device or system whose failure to perform can be reasonably expected to cause the failure of the life support device or to affect its safety or effectiveness.

Customers represent that they have all necessary expertise in the safety and regulatory ramifications of their life support devices or systems, and acknowledge and agree that they are solely responsible for all legal, regulatory and safety-related requirements concerning their products and any use of Diodes Incorporated products in such safety-critical, life support devices or systems, notwithstanding any devices- or systems-related information or support that may be provided by Diodes Incorporated. Further, Customers must fully indemnify Diodes Incorporated and its representatives against any damages arising out of the use of Diodes Incorporated products in such safety-critical, life support devices or systems.

Copyright © 2009, Diodes Incorporated

www.diodes.com