

## Features

- Ideal for Medium Power Amplification and Switching
- Ultra Low Collector-Emitter Saturation Voltage
- Complimentary NPN Type Available (DSS20201L)
- **Lead Free By Design/RoHS Compliant (Note 1)**
- **“Green” Device (Note 2)**

## Mechanical Data

- Case: SOT-23
- Case Material: Molded Plastic, "Green" Molding Compound. UL Flammability Classification Rating 94V-0
- Moisture Sensitivity: Level 1 per J-STD-020D
- Terminals: Finish — Matte Tin annealed over Copper leadframe. Solderable per MIL-STD-202, Method 208
- Marking Information: See Page 4
- Ordering Information: See Page 4
- Weight: 0.008 grams (approximate)



Top View

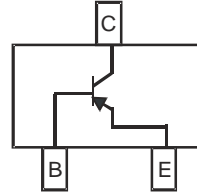

Device Schematic

## Maximum Ratings @ $T_A = 25^\circ\text{C}$ unless otherwise specified

Characteristic	Symbol	Value	Unit
Collector-Base Voltage	$V_{CBO}$	-20	V
Collector-Emitter Voltage	$V_{CEO}$	-20	V
Emitter-Base Voltage	$V_{EBO}$	-7	V
Peak Pulse Collector Current	$I_{CM}$	-4	A
Continuous Collector Current	$I_C$	-2	A

## Thermal Characteristics

Characteristic	Symbol	Value	Unit
Power Dissipation (Note 3) @ $T_A = 25^\circ\text{C}$	$P_D$	600	mW
Thermal Resistance, Junction to Ambient Air (Note 3) @ $T_A = 25^\circ\text{C}$	$R_{\theta JA}$	209	$^\circ\text{C/W}$
Power Dissipation (Note 4) @ $T_A = 25^\circ\text{C}$	$P_D$	1.2	mW
Thermal Resistance, Junction to Ambient Air (Note 4) @ $T_A = 25^\circ\text{C}$	$R_{\theta JA}$	104	$^\circ\text{C/W}$
Operating and Storage Temperature Range	$T_J, T_{STG}$	-55 to +150	$^\circ\text{C}$

- Notes:
1. No purposefully added lead.
  2. Diodes Inc.'s "Green" policy can be found on our website at [http://www.diodes.com/products/lead\\_free/index.php](http://www.diodes.com/products/lead_free/index.php).
  3. Device mounted on FR-4 PCB with minimum recommended pad layout.
  4. Device mounted on FR-4 PCB with 1 inch<sup>2</sup> copper pad layout.

**Electrical Characteristics** @T<sub>A</sub> = 25°C unless otherwise specified

Characteristic	Symbol	Min	Typ	Max	Unit	Test Conditions
<b>OFF CHARACTERISTICS</b>						
Collector-Base Breakdown Voltage	V <sub>(BR)CBO</sub>	-20	—	—	V	I <sub>C</sub> = -100μA
Collector-Emitter Breakdown Voltage (Note 5)	V <sub>(BR)CEO</sub>	-20	—	—	V	I <sub>C</sub> = -10mA
Emitter-Base Breakdown Voltage	V <sub>(BR)EBO</sub>	-7	—	—	V	I <sub>E</sub> = -100μA
Collector-Base Cutoff Current	I <sub>CBO</sub>	—	—	-100	nA	V <sub>CB</sub> = -20V, I <sub>E</sub> = 0
Emitter-Base Cutoff Current	I <sub>EBO</sub>	—	—	-100	nA	V <sub>EB</sub> = -7V, I <sub>C</sub> = 0
<b>ON CHARACTERISTICS (Note 5)</b>						
DC Current Gain	h <sub>FE</sub>	250	—	—	—	V <sub>CE</sub> = -2V, I <sub>C</sub> = -10mA
		250	—	—		V <sub>CE</sub> = -2V, I <sub>C</sub> = -500mA
		180	—	—		V <sub>CE</sub> = -2V, I <sub>C</sub> = -1A
		150	—	—		V <sub>CE</sub> = -2V, I <sub>C</sub> = -2A
Collector-Emitter Saturation Voltage	V <sub>CE(SAT)</sub>	—	—	-13	mV	I <sub>C</sub> = -0.1A, I <sub>B</sub> = -10mA
		—	-50	-90		I <sub>C</sub> = -1A, I <sub>B</sub> = -100mA
		—	-100	-120		I <sub>C</sub> = -1A, I <sub>B</sub> = -10mA
		—	-80	-180		I <sub>C</sub> = -2A, I <sub>B</sub> = -200mA
Equivalent On-Resistance	R <sub>CE(SAT)</sub>	—	40	90	mΩ	I <sub>C</sub> = -2A, I <sub>B</sub> = -200mA
Base-Emitter Saturation Voltage	V <sub>BE(SAT)</sub>	—	—	-0.9	V	I <sub>C</sub> = -1A, I <sub>B</sub> = -10mA
Base-Emitter Turn-on Voltage	V <sub>BE(ON)</sub>	—	—	-0.9	V	V <sub>CE</sub> = -2V, I <sub>C</sub> = -1A
<b>SMALL SIGNAL CHARACTERISTICS</b>						
Transition Frequency	f <sub>T</sub>	100	—	—	MHz	V <sub>CE</sub> = -5V, I <sub>C</sub> = -100mA, f = 100MHz
Output Capacitance	C <sub>obo</sub>	—	—	100	pF	V <sub>CB</sub> = -3V, f = 1MHz
Input Capacitance	C <sub>ibo</sub>	—	—	330	pF	V <sub>EB</sub> = -0.5V, f = 1MHz
<b>SWITCHING CHARACTERISTICS</b>						
Turn-On Time	t <sub>on</sub>	—	—	180	ns	V <sub>CC</sub> = -15V, I <sub>C</sub> = -750mA, I <sub>B1</sub> = -15mA
Delay Time	t <sub>d</sub>	—	—	60	ns	
Rise Time	t <sub>r</sub>	—	—	120	ns	
Turn-Off Time	t <sub>off</sub>	—	—	430	ns	V <sub>CC</sub> = -15V, I <sub>C</sub> = -750mA, I <sub>B1</sub> = I <sub>B2</sub> = -15mA
Storage Time	t <sub>s</sub>	—	—	300	ns	
Fall Time	t <sub>f</sub>	—	—	130	ns	

Notes: 5. Measured under pulsed conditions. Pulse width = 300μs. Duty cycle ≤2%.

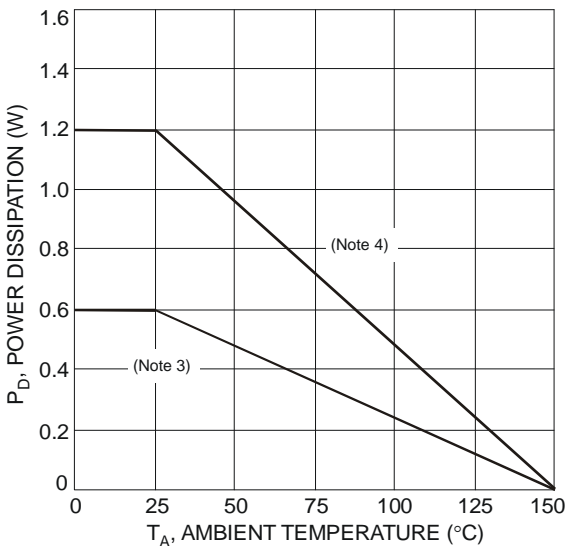

Fig. 1 Power Dissipation vs. Ambient Temperature

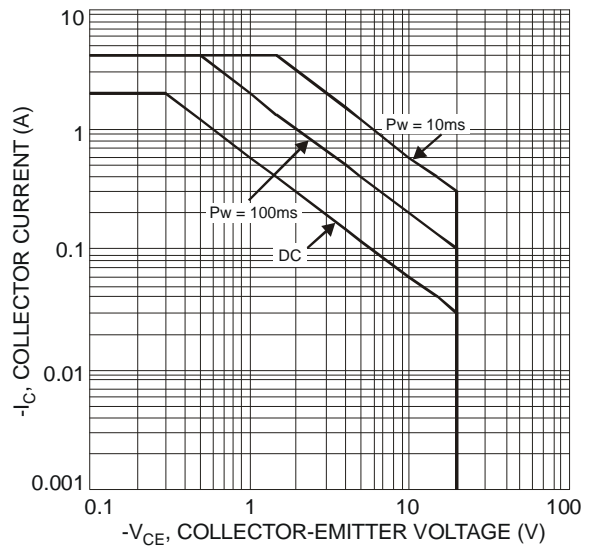

Fig. 2 Typical Collector Current vs. Collector-Emitter Voltage

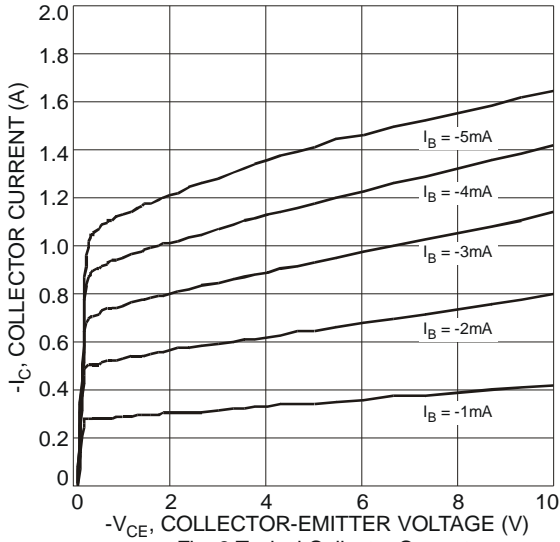

Fig. 3 Typical Collector Current vs. Collector-Emitter Voltage

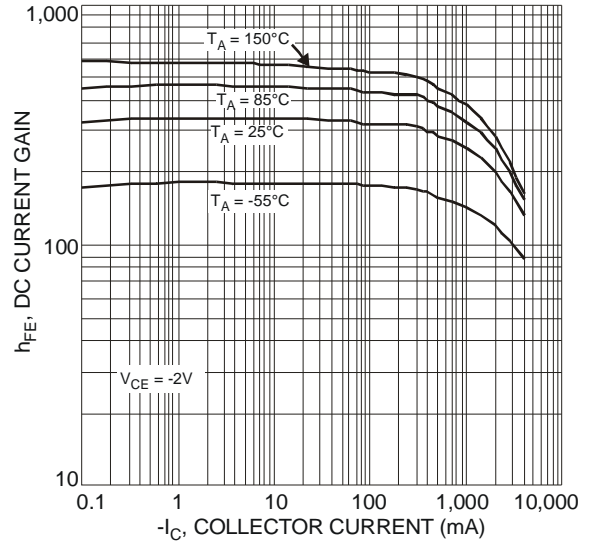

Fig. 4 Typical DC Current Gain vs. Collector Current

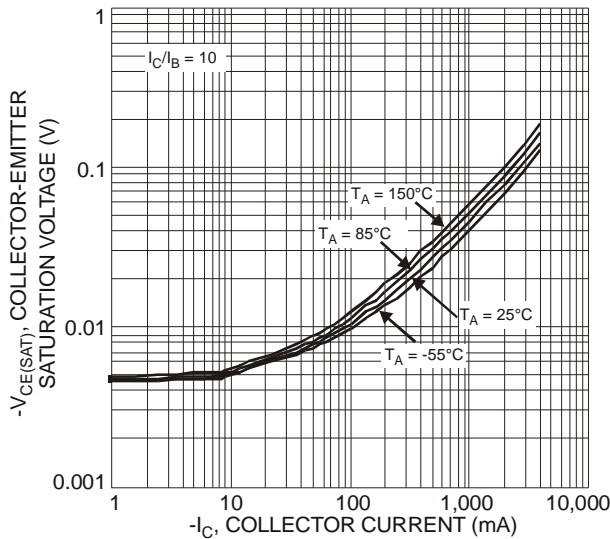

Fig. 5 Typical Collector-Emitter Saturation Voltage vs. Collector Current

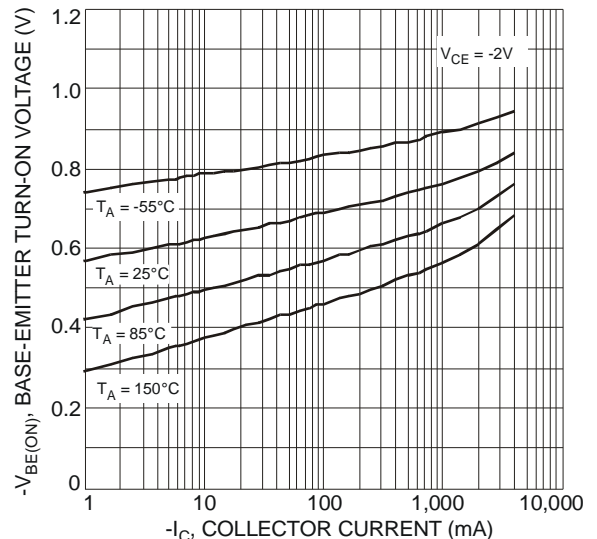

Fig. 6 Typical Base-Emitter Turn-On Voltage vs. Collector Current

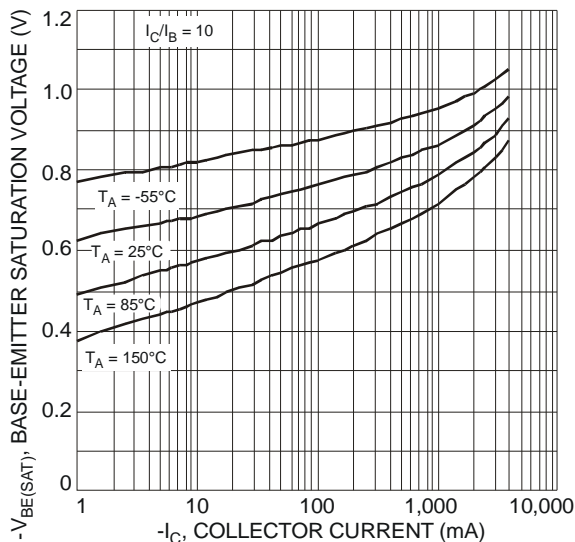

Fig. 7 Typical Base-Emitter Saturation Voltage vs. Collector Current

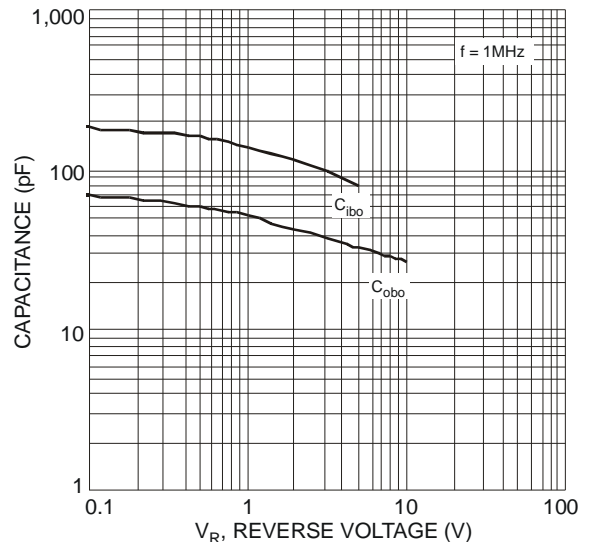

Fig. 8 Typical Capacitance Characteristics

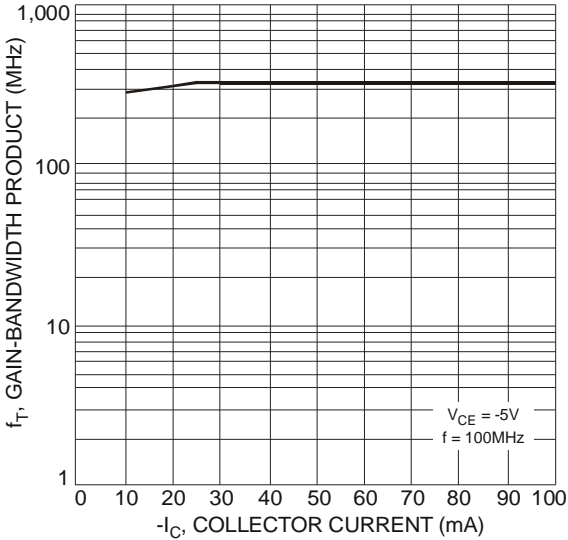

Fig. 9 Typical Gain-Bandwidth Product vs. Collector Current

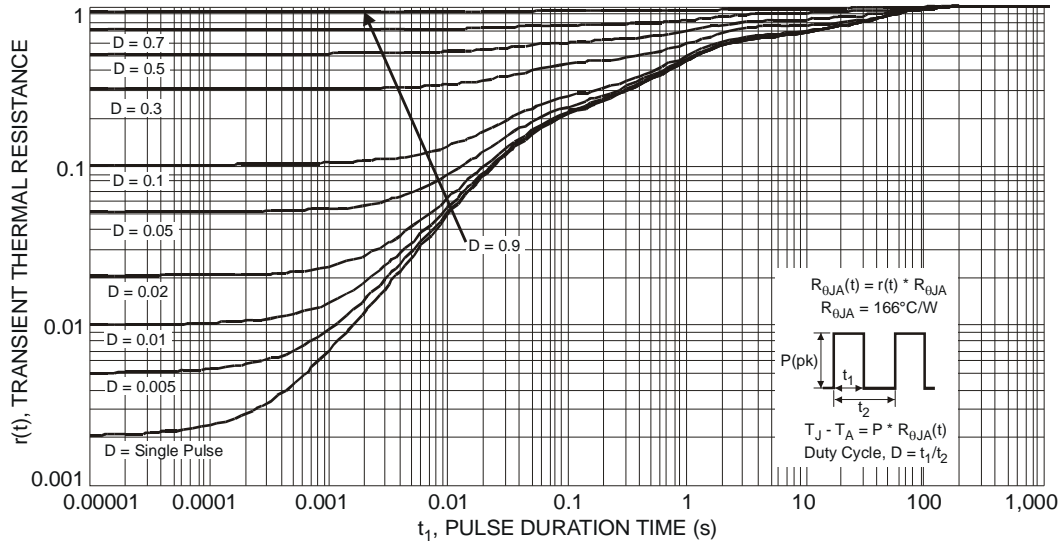

Fig. 10 Transient Thermal Response

**Ordering Information** (Note 6)

Part Number	Case	Packaging
DSS20200L-7	SOT-23	3000/Tape & Reel

Notes: 6. For packaging details, go to our website at <http://www.diodes.com/datasheets/ap02007.pdf>.

**Marking Information**

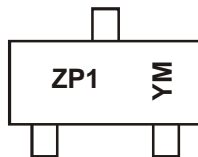

ZP1 = Product Type Marking Code  
 YM = Date Code Marking  
 Y = Year (ex: V = 2008)  
 M = Month (ex: 9 = September)

Date Code Key

Year	2008	2009	2010	2011	2012	2013	2014	2015
Code	V	W	X	Y	Z	A	B	C

Month	Jan	Feb	Mar	Apr	May	Jun	Jul	Aug	Sep	Oct	Nov	Dec
Code	1	2	3	4	5	6	7	8	9	O	N	D

**Package Outline Dimensions**

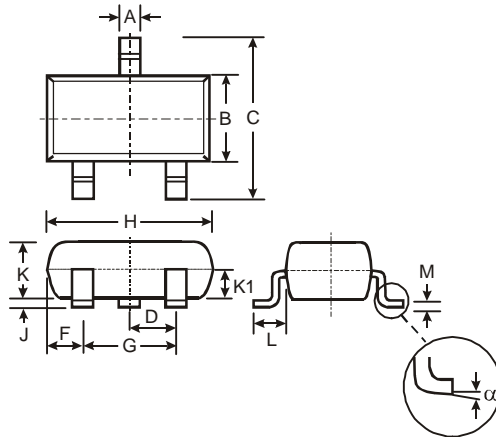

SOT-23			
Dim	Min	Max	Typ
A	0.37	0.51	0.40
B	1.20	1.40	1.30
C	2.30	2.50	2.40
D	0.89	1.03	0.915
F	0.45	0.60	0.535
G	1.78	2.05	1.83
H	2.80	3.00	2.90
J	0.013	0.10	0.05
K	0.903	1.10	1.00
K1	-	-	0.400
L	0.45	0.61	0.55
M	0.085	0.18	0.11
α	0°	8°	-
All Dimensions in mm			

**Suggested Pad Layout**

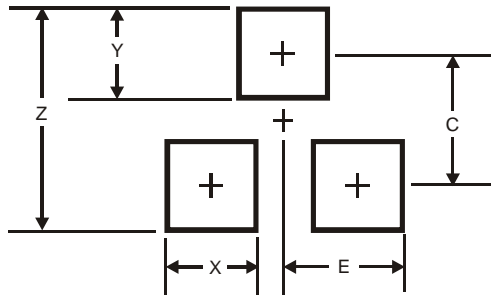

Dimensions	Value (in mm)
Z	2.9
X	0.8
Y	0.9
C	2.0
E	1.35

**IMPORTANT NOTICE**

Diodes Incorporated and its subsidiaries reserve the right to make modifications, enhancements, improvements, corrections or other changes without further notice to any product herein. Diodes Incorporated does not assume any liability arising out of the application or use of any product described herein; neither does it convey any license under its patent rights, nor the rights of others. The user of products in such applications shall assume all risks of such use and will agree to hold Diodes Incorporated and all the companies whose products are represented on our website, harmless against all damages.

**LIFE SUPPORT**

Diodes Incorporated products are not authorized for use as critical components in life support devices or systems without the expressed written approval of the President of Diodes Incorporated.