

MBT3904DW1T1G, MBT3904DW2T1G

Dual General Purpose Transistors

The MBT3904DW1T1G and MBT3904DW2T1G devices are a spin-off of our popular SOT-23/SOT-323 three-leaded device. It is designed for general purpose amplifier applications and is housed in the SOT-363 six-leaded surface mount package. By putting two discrete devices in one package, this device is ideal for low-power surface mount applications where board space is at a premium.

Features

- h_{FE} , 100–300
- Low $V_{CE(sat)}$, ≤ 0.4 V
- Simplifies Circuit Design
- Reduces Board Space
- Reduces Component Count
- Available in 8 mm, 7-inch/3,000 Unit Tape and Reel
- These Devices are Pb-Free, Halogen Free/BFR Free and are RoHS Compliant

MAXIMUM RATINGS

Rating	Symbol	Value	Unit
Collector–Emitter Voltage	V_{CEO}	40	Vdc
Collector–Base Voltage	V_{CBO}	60	Vdc
Emitter–Base Voltage	V_{EBO}	6.0	Vdc
Collector Current – Continuous	I_C	200	mAdc
Electrostatic Discharge	ESD	HBM Class 2 MM Class B	

Stresses exceeding Maximum Ratings may damage the device. Maximum Ratings are stress ratings only. Functional operation above the Recommended Operating Conditions is not implied. Extended exposure to stresses above the Recommended Operating Conditions may affect device reliability.

THERMAL CHARACTERISTICS

Characteristic	Symbol	Max	Unit
Total Package Dissipation (Note 1) $T_A = 25^\circ\text{C}$	P_D	150	mW
Thermal Resistance, Junction-to-Ambient	$R_{\theta JA}$	833	$^\circ\text{C}/\text{W}$
Junction and Storage Temperature Range	T_J, T_{stg}	–55 to +150	$^\circ\text{C}$

1. Device mounted on FR4 glass epoxy printed circuit board using the minimum recommended footprint.



ON Semiconductor®

<http://onsemi.com>

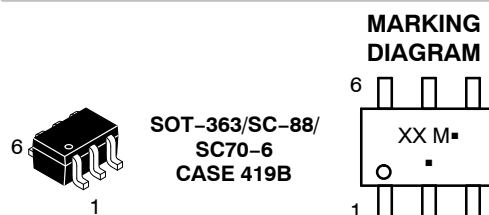

XX = MA for MBT3904DW1T1G
MJ for MBT3904DW2T1G
M = Date Code
▪ = Pb-Free Package
(Note: Microdot may be in either location)

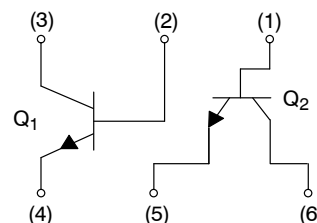
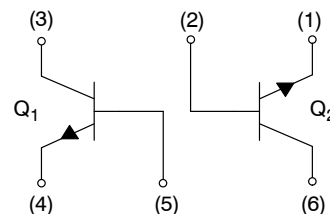

ORDERING INFORMATION

Device	Package	Shipping†
MBT3904DW1T1G	SOT-363 (Pb-Free)	3000 / Tape & Reel
MBT3904DW2T1G	SOT-363 (Pb-Free)	3000 / Tape & Reel

†For information on tape and reel specifications, including part orientation and tape sizes, please refer to our Tape and Reel Packaging Specifications Brochure, BRD8011/D.

MBT3904DW1T1G, MBT3904DW2T1G

ELECTRICAL CHARACTERISTICS (T_A = 25°C unless otherwise noted)

Characteristic	Symbol	Min	Max	Unit
OFF CHARACTERISTICS				
Collector – Emitter Breakdown Voltage (Note 2) (I _C = 1.0 mA _{dc} , I _B = 0)	V _{(BR)CEO}	40	–	V _{dc}
Collector – Base Breakdown Voltage (I _C = 10 μA _{dc} , I _E = 0)	V _{(BR)CBO}	60	–	V _{dc}
Emitter – Base Breakdown Voltage (I _E = 10 μA _{dc} , I _C = 0)	V _{(BR)EBO}	6.0	–	V _{dc}
Base Cutoff Current (V _{CE} = 30 V _{dc} , V _{EB} = 3.0 V _{dc})	I _{BL}	–	50	nA _{dc}
Collector Cutoff Current (V _{CE} = 30 V _{dc} , V _{EB} = 3.0 V _{dc})	I _{CEx}	–	50	nA _{dc}
ON CHARACTERISTICS (Note 2)				
DC Current Gain (I _C = 0.1 mA _{dc} , V _{CE} = 1.0 V _{dc}) (I _C = 1.0 mA _{dc} , V _{CE} = 1.0 V _{dc}) (I _C = 10 mA _{dc} , V _{CE} = 1.0 V _{dc}) (I _C = 50 mA _{dc} , V _{CE} = 1.0 V _{dc}) (I _C = 100 mA _{dc} , V _{CE} = 1.0 V _{dc})	h _{FE}	40 70 100 60 30	– – 300 – –	–
Collector – Emitter Saturation Voltage (I _C = 10 mA _{dc} , I _B = 1.0 mA _{dc}) (I _C = 50 mA _{dc} , I _B = 5.0 mA _{dc})	V _{CE(sat)}	– –	0.2 0.3	V _{dc}
Base – Emitter Saturation Voltage (I _C = 10 mA _{dc} , I _B = 1.0 mA _{dc}) (I _C = 50 mA _{dc} , I _B = 5.0 mA _{dc})	V _{BE(sat)}	0.65 –	0.85 0.95	V _{dc}
SMALL-SIGNAL CHARACTERISTICS				
Current – Gain – Bandwidth Product (I _C = 10 mA _{dc} , V _{CE} = 20 V _{dc} , f = 100 MHz)	f _T	300	–	MHz
Output Capacitance (V _{CB} = 5.0 V _{dc} , I _E = 0, f = 1.0 MHz)	C _{obo}	–	4.0	pF
Input Capacitance (V _{EB} = 0.5 V _{dc} , I _C = 0, f = 1.0 MHz)	C _{ibo}	–	8.0	pF
Input Impedance (V _{CE} = 10 V _{dc} , I _C = 1.0 mA _{dc} , f = 1.0 kHz)	h _{ie}	1.0 2.0	10 12	k Ω
Voltage Feedback Ratio (V _{CE} = 10 V _{dc} , I _C = 1.0 mA _{dc} , f = 1.0 kHz)	h _{re}	0.5 0.1	8.0 10	X 10 ⁻⁴
Small – Signal Current Gain (V _{CE} = 10 V _{dc} , I _C = 1.0 mA _{dc} , f = 1.0 kHz)	h _{fe}	100 100	400 400	–
Output Admittance (V _{CE} = 10 V _{dc} , I _C = 1.0 mA _{dc} , f = 1.0 kHz)	h _{oe}	1.0 3.0	40 60	μmhos
Noise Figure (V _{CE} = 5.0 V _{dc} , I _C = 100 μA _{dc} , R _S = 1.0 k Ω, f = 1.0 kHz)	NF	– –	5.0 4.0	dB

2. Pulse Test: Pulse Width ≤ 300 μs; Duty Cycle ≤ 2.0%.

MBT3904DW1T1G, MBT3904DW2T1G

SWITCHING CHARACTERISTICS

Characteristic		Symbol	Min	Max	Unit
Delay Time	($V_{CC} = 3.0 \text{ Vdc}$, $V_{BE} = -0.5 \text{ Vdc}$)	t_d	-	35	ns
Rise Time	($I_C = 10 \text{ mAdc}$, $I_{B1} = 1.0 \text{ mAdc}$)	t_r	-	35	
Storage Time	($V_{CC} = 3.0 \text{ Vdc}$, $I_C = 10 \text{ mAdc}$)	t_s	-	200	ns
Fall Time	($I_{B1} = I_{B2} = 1.0 \text{ mAdc}$)	t_f	-	50	

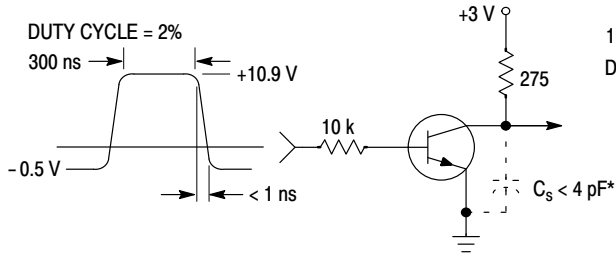

Figure 1. Delay and Rise Time Equivalent Test Circuit

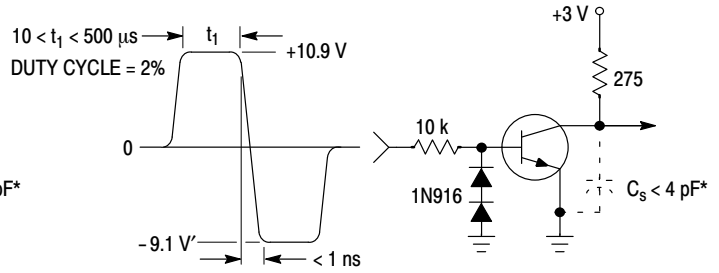

Figure 2. Storage and Fall Time Equivalent Test Circuit

* Total shunt capacitance of test jig and connectors

MBT3904DW1T1G, MBT3904DW2T1G

TYPICAL TRANSIENT CHARACTERISTICS

— $T_J = 25^\circ\text{C}$
 - - - $T_J = 125^\circ\text{C}$

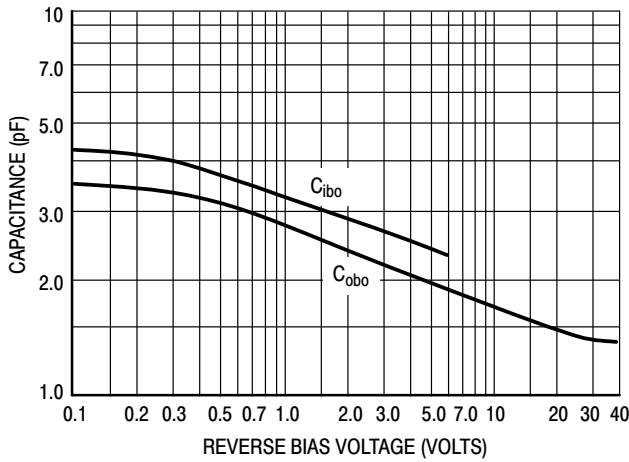

Figure 3. Capacitance

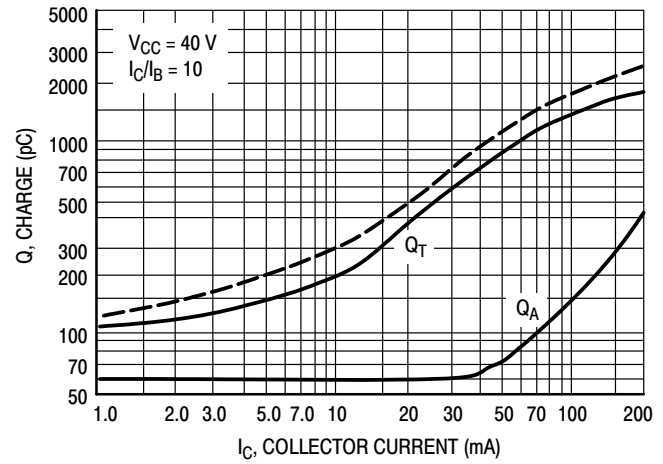

Figure 4. Charge Data

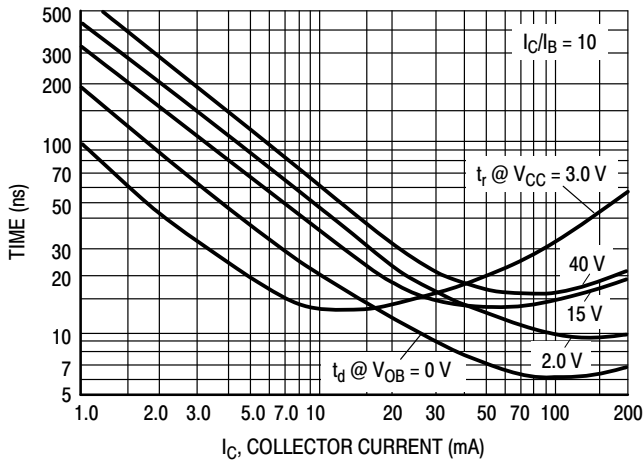

Figure 5. Turn-On Time

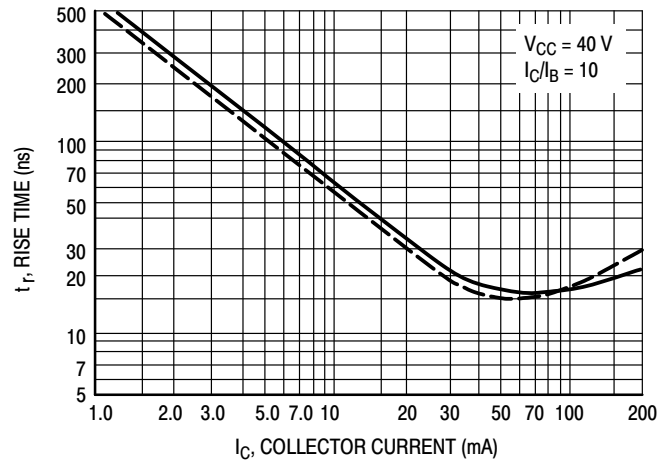

Figure 6. Rise Time

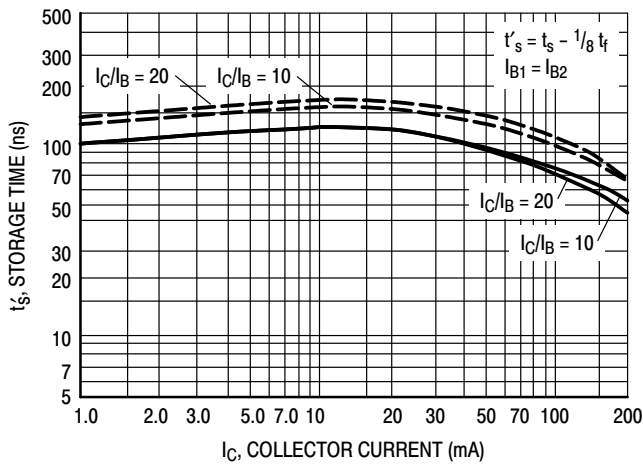

Figure 7. Storage Time

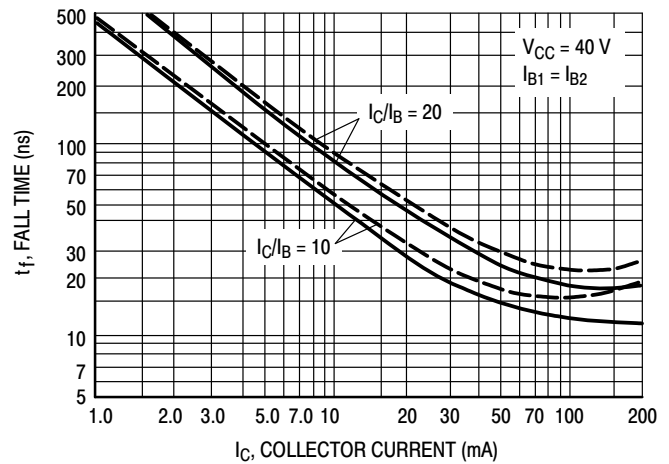

Figure 8. Fall Time

MBT3904DW1T1G, MBT3904DW2T1G

TYPICAL AUDIO SMALL-SIGNAL CHARACTERISTICS NOISE FIGURE VARIATIONS

($V_{CE} = 5.0$ Vdc, $T_A = 25^\circ\text{C}$, Bandwidth = 1.0 Hz)

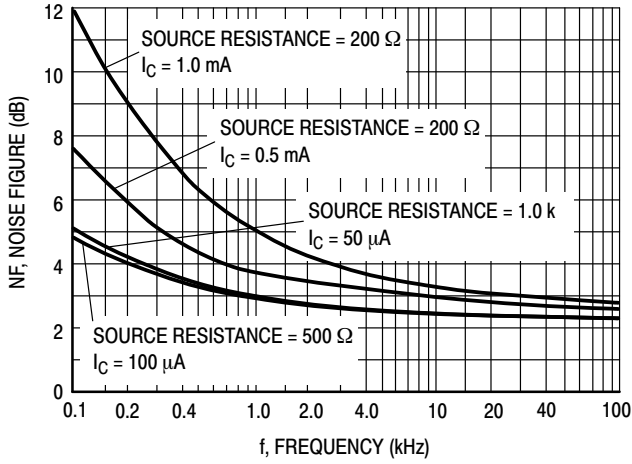

Figure 9. Noise Figure

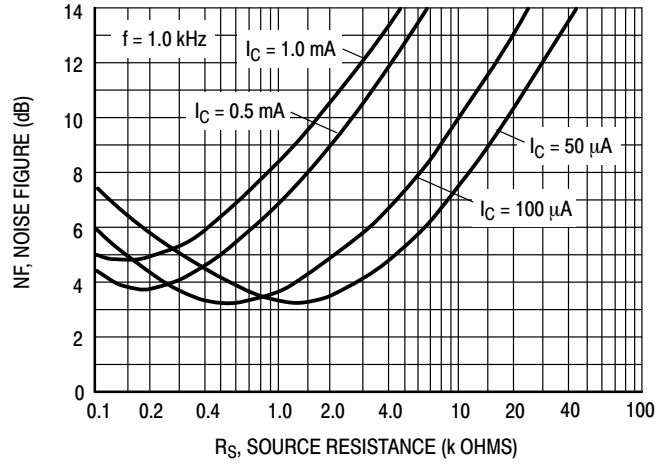

Figure 10. Noise Figure

h PARAMETERS

($V_{CE} = 10$ Vdc, $f = 1.0$ kHz, $T_A = 25^\circ\text{C}$)

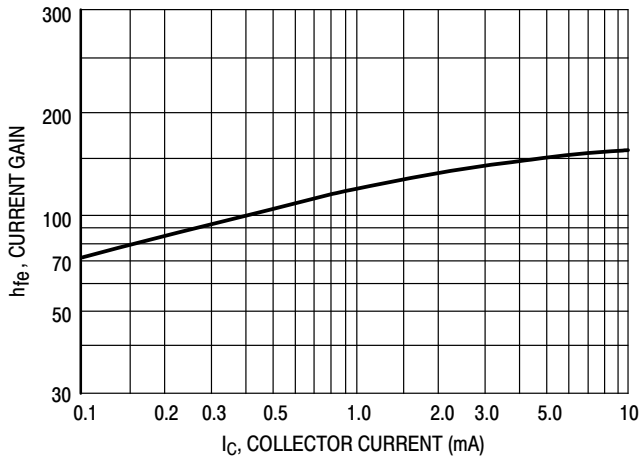

Figure 11. Current Gain

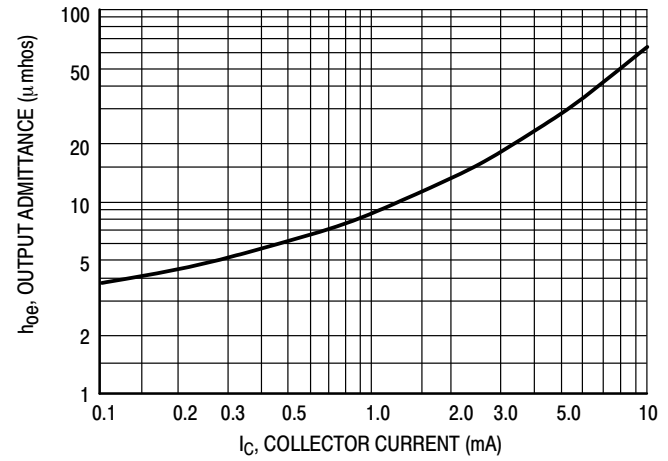

Figure 12. Output Admittance

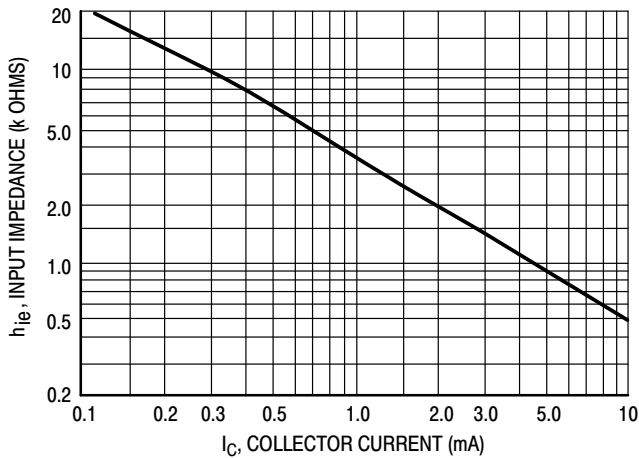

Figure 13. Input Impedance

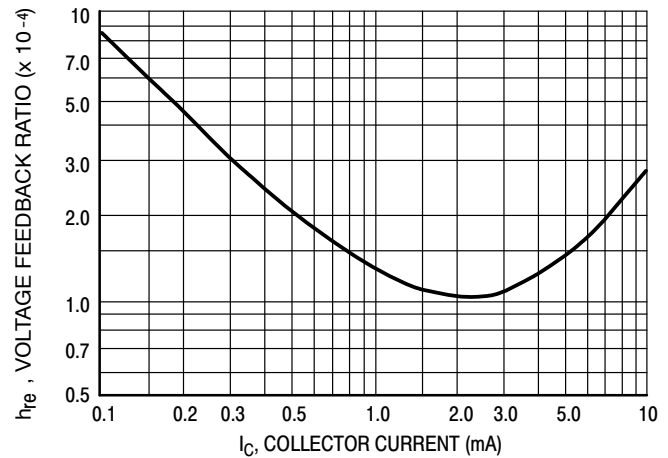

Figure 14. Voltage Feedback Ratio

MBT3904DW1T1G, MBT3904DW2T1G

TYPICAL STATIC CHARACTERISTICS

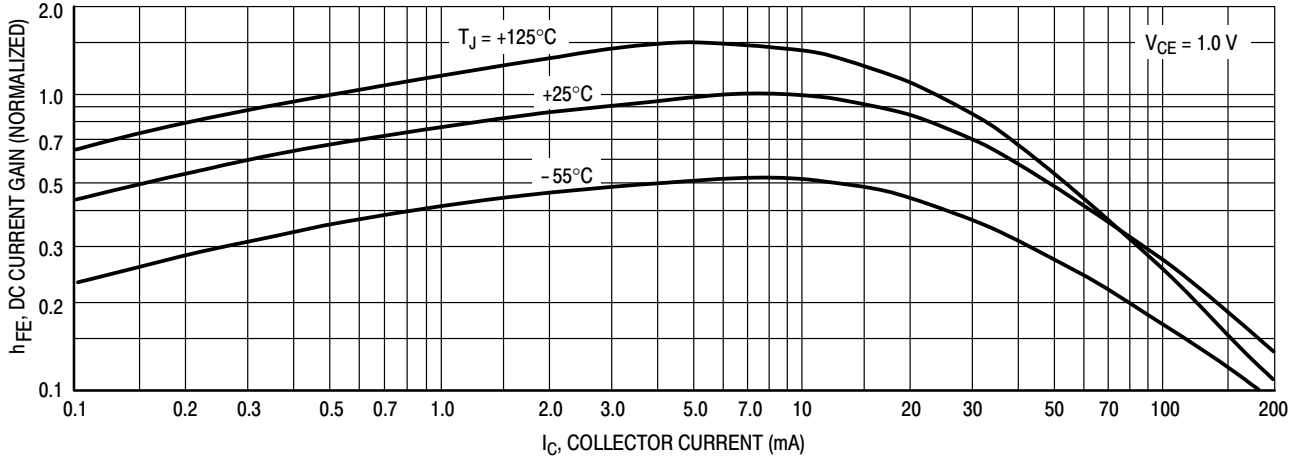

Figure 15. DC Current Gain

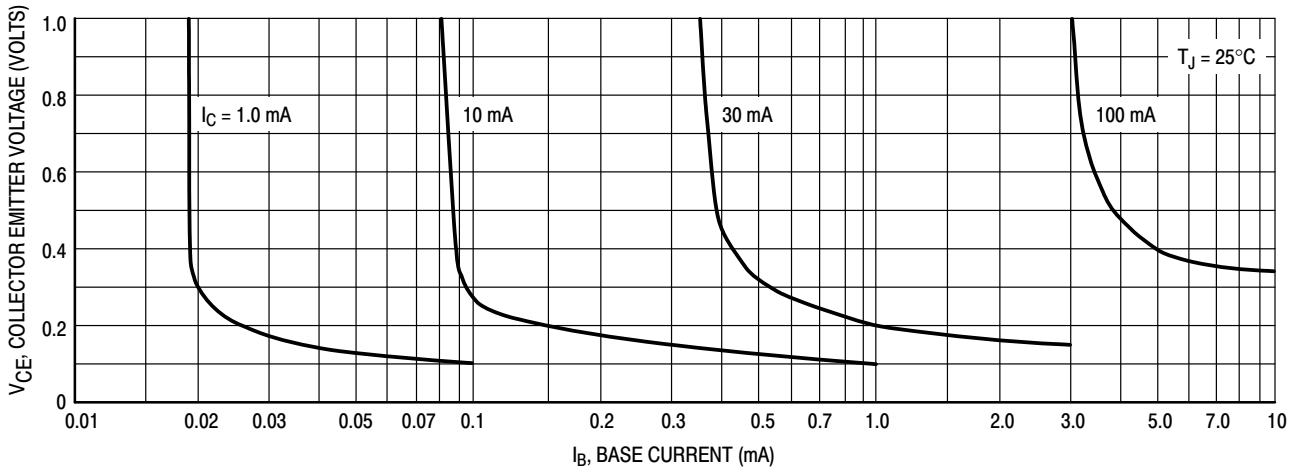

Figure 16. Collector Saturation Region

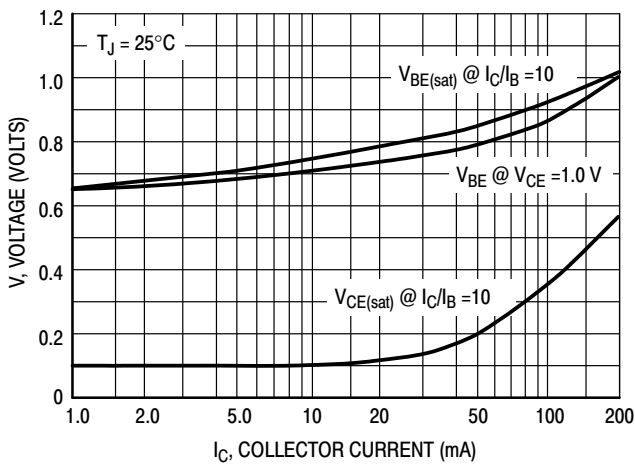

Figure 17. "ON" Voltages

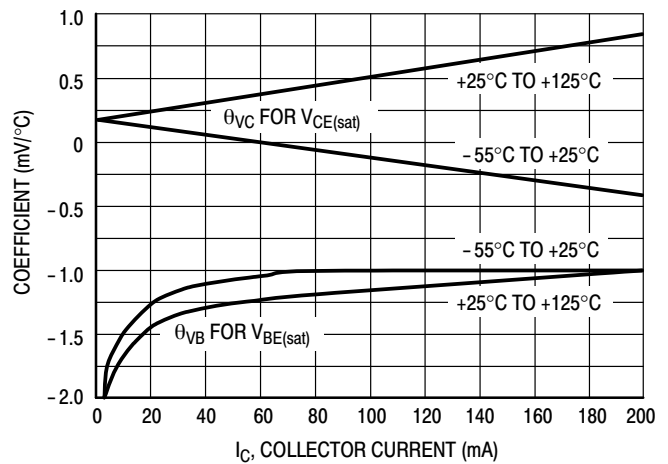

Figure 18. Temperature Coefficients

MBT3904DW1T1G, MBT3904DW2T1G

TYPICAL STATIC CHARACTERISTICS

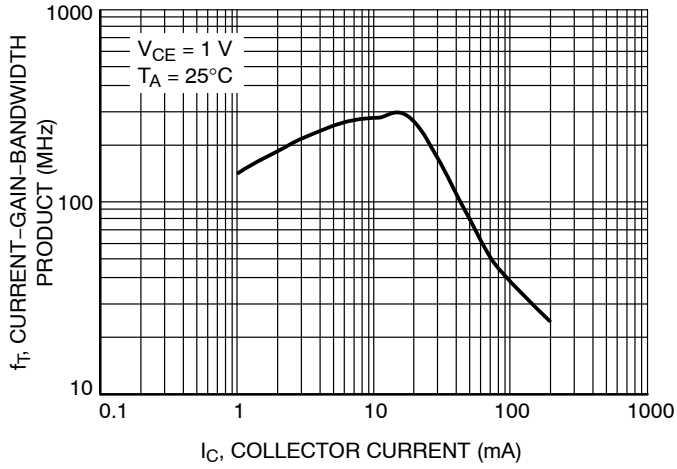

Figure 19. Current Gain Bandwidth Product

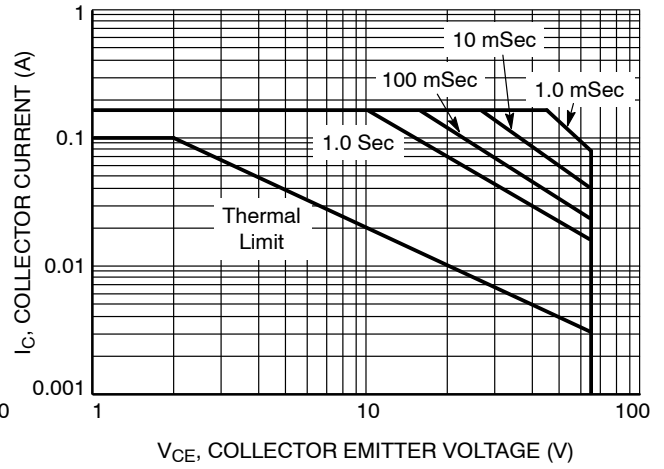
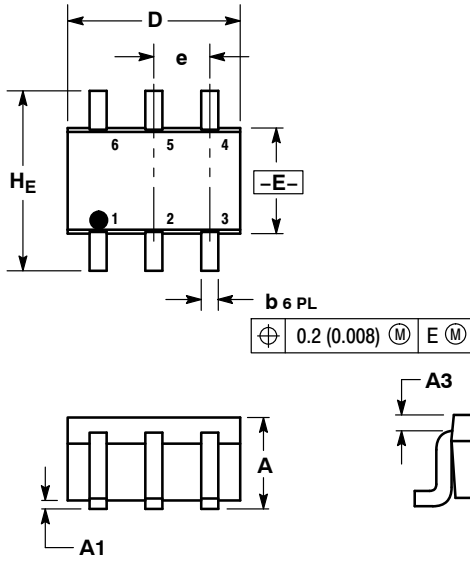

Figure 20. Safe Operating Area

MBT3904DW1T1G, MBT3904DW2T1G

PACKAGE DIMENSIONS

SOT-363/SC-88/SC70-6
CASE 419B-02
ISSUE W



NOTES:

1. DIMENSIONING AND TOLERANCING PER ANSI Y14.5M, 1982.
2. CONTROLLING DIMENSION: INCH.
3. 419B-01 OBSOLETE, NEW STANDARD 419B-02.

DIM	MILLIMETERS			INCHES		
	MIN	NOM	MAX	MIN	NOM	MAX
A	0.80	0.95	1.10	0.031	0.037	0.043
A1	0.00	0.05	0.10	0.000	0.002	0.004
A3	0.20 REF			0.008 REF		
b	0.10	0.21	0.30	0.004	0.008	0.012
C	0.10	0.14	0.25	0.004	0.005	0.010
D	1.80	2.00	2.20	0.070	0.078	0.086
E	1.15	1.25	1.35	0.045	0.049	0.053
e	0.65 BSC			0.026 BSC		
L	0.10	0.20	0.30	0.004	0.008	0.012
HE	2.00	2.10	2.20	0.078	0.082	0.086

STYLE 1:

- PIN 1. EMITTER 2
2. BASE 2
3. COLLECTOR 1
4. EMITTER 1
5. BASE 1
6. COLLECTOR 2

STYLE 27:

- PIN 1. BASE 2
2. BASE 1
3. COLLECTOR 1
4. EMITTER 1
5. EMITTER 2
6. COLLECTOR 2

SOLDERING FOOTPRINT*

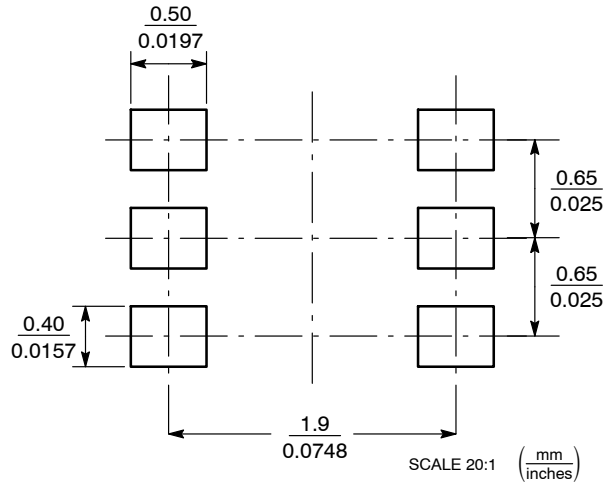

*For additional information on our Pb-Free strategy and soldering details, please download the ON Semiconductor Soldering and Mounting Techniques Reference Manual, SOLDERRM/D.

ON Semiconductor and are registered trademarks of Semiconductor Components Industries, LLC (SCILLC). SCILLC reserves the right to make changes without further notice to any products herein. SCILLC makes no warranty, representation or guarantee regarding the suitability of its products for any particular purpose, nor does SCILLC assume any liability arising out of the application or use of any product or circuit, and specifically disclaims any and all liability, including without limitation special, consequential or incidental damages. "Typical" parameters which may be provided in SCILLC data sheets and/or specifications can and do vary in different applications and actual performance may vary over time. All operating parameters, including "Typicals" must be validated for each customer application by customer's technical experts. SCILLC does not convey any license under its patent rights nor the rights of others. SCILLC products are not designed, intended, or authorized for use as components in systems intended for surgical implant into the body, or other applications intended to support or sustain life, or for any other application in which the failure of the SCILLC product could create a situation where personal injury or death may occur. Should Buyer purchase or use SCILLC products for any such unintended or unauthorized application, Buyer shall indemnify and hold SCILLC and its officers, employees, subsidiaries, affiliates, and distributors harmless against all claims, costs, damages, and expenses, and reasonable attorney fees arising out of, directly or indirectly, any claim of personal injury or death associated with such unintended or unauthorized use, even if such claim alleges that SCILLC was negligent regarding the design or manufacture of the part. SCILLC is an Equal Opportunity/Affirmative Action Employer. This literature is subject to all applicable copyright laws and is not for resale in any manner.

PUBLICATION ORDERING INFORMATION

LITERATURE FULFILLMENT:
Literature Distribution Center for ON Semiconductor
P.O. Box 5163, Denver, Colorado 80217 USA
Phone: 303-675-2175 or 800-344-3860 Toll Free USA/Canada
Fax: 303-675-2176 or 800-344-3867 Toll Free USA/Canada
Email: orderlit@onsemi.com

N. American Technical Support: 800-282-9855 Toll Free
USA/Canada
Europe, Middle East and Africa Technical Support:
Phone: 421 33 790 2910
Japan Customer Focus Center
Phone: 81-3-5773-3850

ON Semiconductor Website: www.onsemi.com

Order Literature: <http://www.onsemi.com/orderlit>

For additional information, please contact your local Sales Representative

MBT3904DW1T1/D