

Phase Control Thyristor

$$V_{RRM} = 1200-1600 \text{ V}$$

$$I_{T(RMS)} = 30 \text{ A}$$

$$I_{T(AV)M} = 19 \text{ A}$$

V_{RSM} V_{DSM} V	V_{RRM} V_{DRM} V	Type
1200	1200	CS 20-12io1
1400	1400	CS 20-14io1
1600	1600	CS 20-16io1

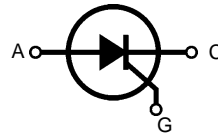

TO-247 AD

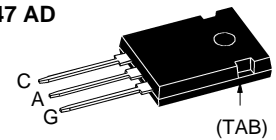

C = Cathode, A = Anode, G = Gate
TAB = Anode

Symbol	Test Conditions	Maximum Ratings
$I_{T(RMS)}$	$T_{VJ} = T_{VJM}$	30 A
$I_{T(AV)M}$	$T_{case} = 85^{\circ}\text{C}; 180^{\circ}$ sine	19 A
I_{TSM}	$T_{VJ} = 45^{\circ}\text{C};$ $V_R = 0 \text{ V}$	t = 10 ms (50 Hz), sine 200 A
		t = 8.3 ms (60 Hz), sine 215 A
I^2t	$T_{VJ} = T_{VJM}$ $V_R = 0 \text{ V}$	t = 10 ms (50 Hz), sine 180 A
		t = 8.3 ms (60 Hz), sine 195 A
$(di/dt)_{cr}$	$T_{VJ} = T_{VJM}$ f = 50 Hz, $t_p = 200 \mu\text{s}$ $V_D = 2/3 V_{DRM}$ $I_G = 0.3 \text{ A}$ $di_G/dt = 0.3 \text{ A}/\mu\text{s}$	repetitive, $I_T = 40 \text{ A}$ 150 A/ μs
		non repetitive, $I_T = I_{T(AV)M}$ 500 A/ μs
$(dv/dt)_{cr}$	$T_{VJ} = T_{VJM}$ $R_{GK} = \infty$; method 1 (linear voltage rise)	$V_{DR} = 2/3 V_{DRM}$ 1000 V/ μs
P_{GM}	$T_{VJ} = T_{VJM}$	$t_p = 30 \mu\text{s}$ 10 W
P_{GAV}	$I_T = I_{T(AV)M}$	$t_p = 300 \mu\text{s}$ 5 W
V_{RGM}		0.5 W
T_{VJ}		10 V
T_{VJM}		-40...+125 $^{\circ}\text{C}$
T_{stg}		125 $^{\circ}\text{C}$
M_d	Mounting torque M3	-40...+125 $^{\circ}\text{C}$
Weight		0.8...1.2 Nm 6 g

Features

- Thyristor for line frequency
- International standard package JEDEC TO-247
- Planar passivated chip
- Long-term stability of blocking currents and voltages
- Epoxy meets UL 94V-0

Applications

- Motor control
- Power converter
- AC power controller
- Switch-mode and resonant mode power supplies
- Light and temperature control

Advantages

- Easy to mount with 1 screw (isolated mounting screw hole)
- Space and weight savings
- Simple mounting
- Improved temperature and power cycling

Data according to IEC 60747
IXYS reserves the right to change limits, test conditions and dimensions

Symbol	Test Conditions	Characteristic Values	
$I_{R'} I_D$	$T_{VJ} = T_{VJM}; V_R = V_{RRM}; V_D = V_{DRM}$	\leq	2 mA
V_T	$I_T = 25 \text{ A}; T_{VJ} = 25^\circ\text{C}$	\leq	2.1 V
V_{T0}	For power-loss calculations only ($T_{VJ} = 125^\circ\text{C}$)		1.1 V
r_T			40 mΩ
V_{GT}	$V_D = 6 \text{ V}; T_{VJ} = 25^\circ\text{C}$	\leq	1.0 V
	$T_{VJ} = -40^\circ\text{C}$	\leq	1.2 V
I_{GT}	$V_D = 6 \text{ V}; T_{VJ} = 25^\circ\text{C}$	\leq	65 mA
	$T_{VJ} = -40^\circ\text{C}$	\leq	80 mA
	$T_{VJ} = 125^\circ\text{C}$	\leq	50 mA
V_{GD}	$T_{VJ} = T_{VJM}; V_D = 2/3 V_{DRM}$	\leq	0.2 V
I_{GD}		\leq	5 mA
I_L	$T_{VJ} = 25^\circ\text{C}; t_p = 10 \mu\text{s}$ $I_G = 0.3 \text{ A}; di_G/dt = 0.3 \text{ A}/\mu\text{s}$	\leq	150 mA
I_H	$T_{VJ} = 25^\circ\text{C}; V_D = 6 \text{ V}; R_{GK} = \infty$	\leq	100 mA
t_{gd}	$T_{VJ} = 25^\circ\text{C}; V_D = 1/2 V_{DRM}$ $I_G = 0.3 \text{ A}; di_G/dt = 0.3 \text{ A}/\mu\text{s}$	\leq	2 μs
R_{thJC}	DC current		0.62 K/W
R_{thJH}	DC current		0.82 K/W
a	Max. acceleration, 50 Hz		50 m/s ²

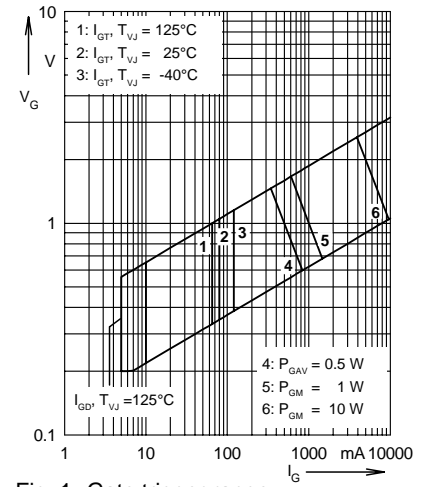

Fig. 1 Gate trigger range

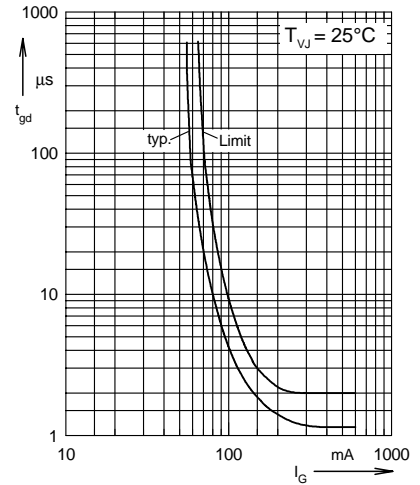
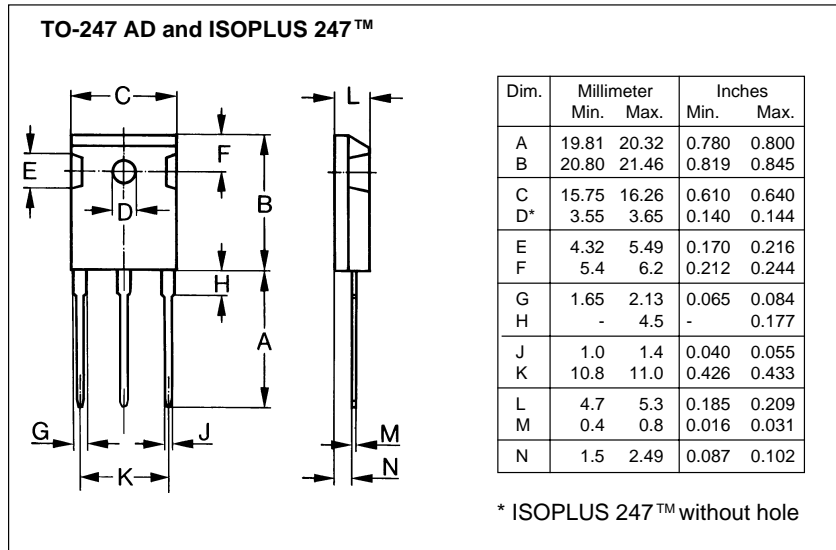

Fig. 2 Gate controlled delay time t_{gd}



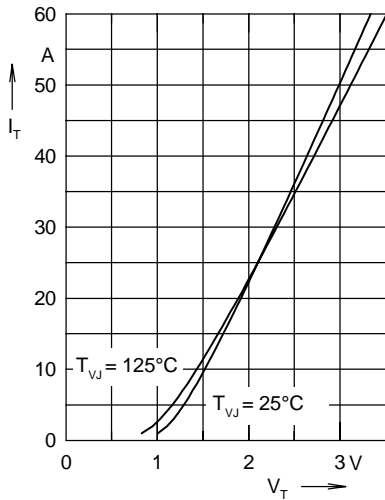

Fig. 3 Forward characteristics

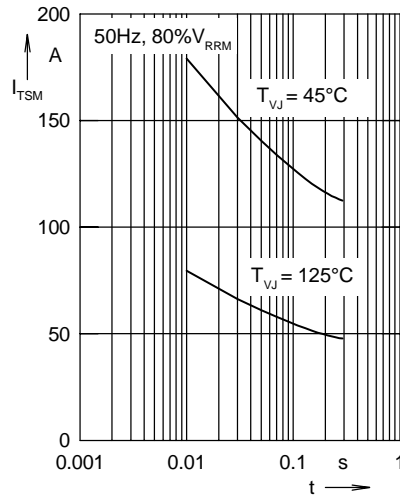

Fig. 4 Surge overload current
 I_{TSM} : crest value, t : duration

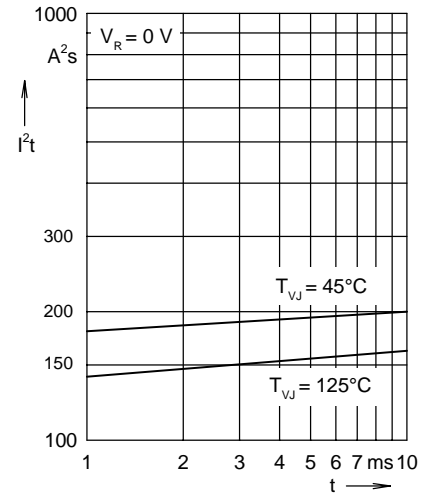

Fig. 5 I^2t versus time (1-10 ms)

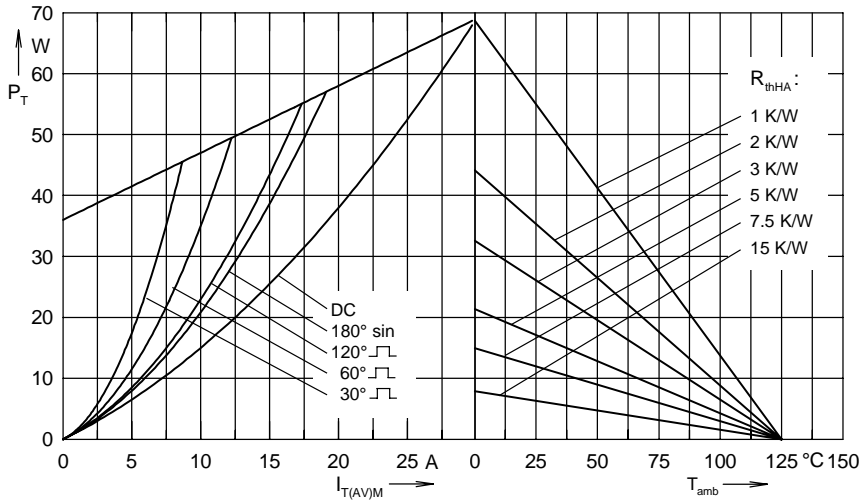

Fig. 6 Power dissipation versus forward current and ambient temperature

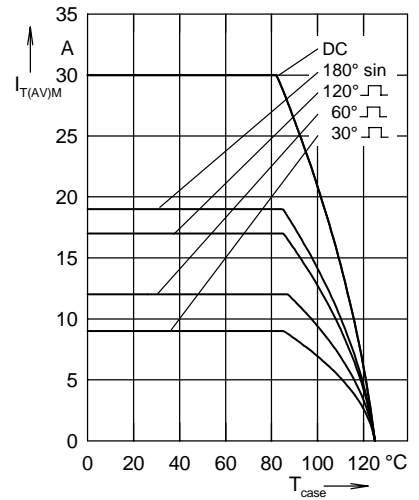

Fig. 7 Max. forward current at case temperature

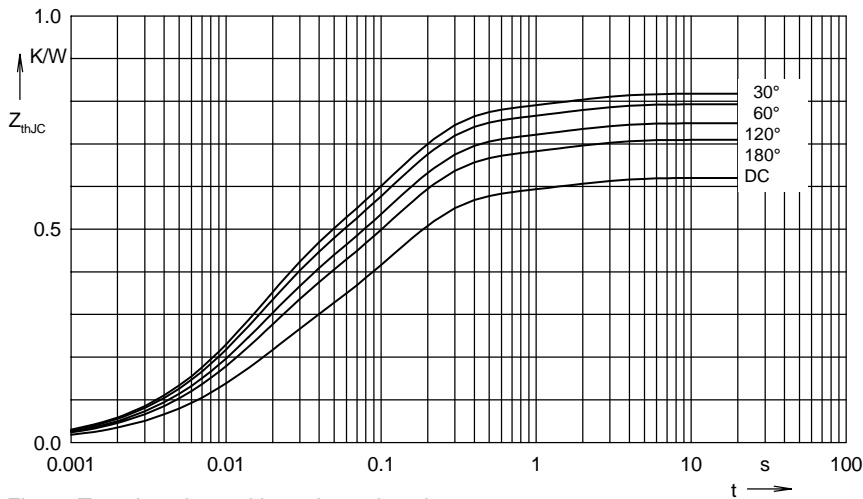

Fig. 8 Transient thermal impedance junction to case

R_{thJC} for various conduction angles d :

d	R_{thJC} (K/W)
DC	0.62
180°	0.71
120°	0.748
60°	0.793
30°	0.817

Constants for Z_{thJC} calculation:

i	R_{thi} (K/W)	t_i (s)
1	0.206	0.013
2	0.362	0.118
3	0.052	1.488