



# SD1487

## RF POWER BIPOLAR TRANSISTORS HF SSB APPLICATIONS

### FEATURES SUMMARY

- 30 MHz
- 12.5 VOLTS
- IMD -30 dB
- COMMON EMITTER
- GOLD METALLIZATION
- $P_{OUT} = 100\text{ W MIN. WITH } 12.0\text{ dB GAIN}$

### DESCRIPTION

The SD1487 is a 12.5 V Class C epitaxial silicon NPN planar transistor designed primarily for HF communications. This device utilizes state-of-the-art diffused emitter ballasting to achieve extreme ruggedness under severe operating conditions.

Figure 1. Package

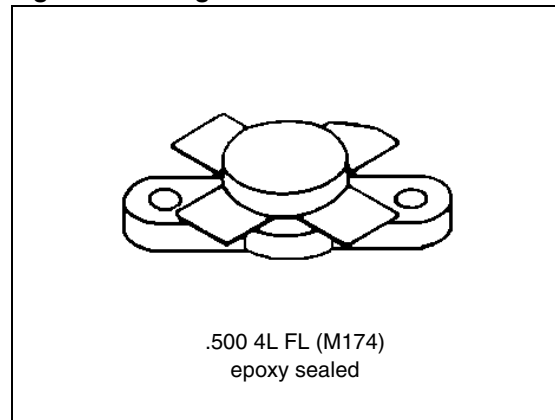

Figure 2. Pin Connection

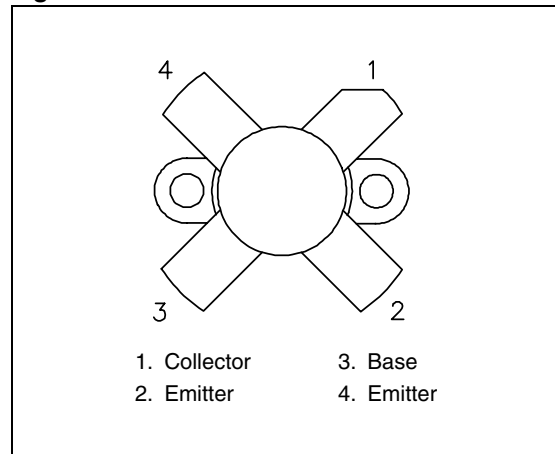

Table 1. Order Codes

Order Codes	Marking	Package	Packaging
SD1487	SD1487	M174	PLASTIC TRAYS

**Table 2. Absolute Maximum Ratings (T<sub>case</sub> = 25°C)**

Symbol	Parameter	Value	Unit
V <sub>CBO</sub>	Collector-Base Voltage	36	V
V <sub>CEO</sub>	Collector-Emitter Voltage	18	V
V <sub>EBO</sub>	Emitter-Base Voltage	4.0	V
I <sub>C</sub>	Device Current	20	A
P <sub>DISS</sub>	Power Dissipation	290	W
T <sub>J</sub>	Junction Temperature	+200	°C
T <sub>STG</sub>	Storage Temperature	- 65 to +150	°C

**Table 3. Thermal Data**

Symbol	Parameter	Value	Unit
R <sub>TH(j-c)</sub>	Junction-Case Thermal Resistance	0.6	°C/W

**ELECTRICAL SPECIFICATIONS (T<sub>case</sub> = 25°C)****Table 4. Static**

Symbol	Test Conditions	Value			Unit
		Min.	Typ.	Max.	
BV <sub>CBO</sub>	I <sub>C</sub> = 100 mA; I <sub>E</sub> = 0 mA	36	—	—	V
BV <sub>CES</sub>	I <sub>C</sub> = 100 mA; V <sub>BE</sub> = 0 V	36	—	—	V
BV <sub>CEO</sub>	I <sub>C</sub> = 100 mA; I <sub>B</sub> = 0 mA	18	—	—	V
BV <sub>EBO</sub>	I <sub>E</sub> = 20 mA; I <sub>C</sub> = 0 mA	4.0	—	—	V
I <sub>CES</sub>	V <sub>CE</sub> = 15 V; I <sub>E</sub> = 0 mA	—	—	20	mA
h <sub>FE</sub>	V <sub>CE</sub> = 5 V; I <sub>C</sub> = 5 A	10	—	200	—

**Table 5. Dynamic**

Symbol	Test Conditions	Value			Unit
		Min.	Typ.	Max.	
P <sub>OUT</sub>	f = 30 MHz; V <sub>CE</sub> = 12.5 V; I <sub>CQ</sub> = 150 mA	100	—	—	W
G <sub>P</sub>	f = 30 MHz; V <sub>CE</sub> = 12.5 V; I <sub>CQ</sub> = 150 mA	11	13	—	dB
IMD <sub>3</sub> <sup>(1)</sup>	P <sub>OUT</sub> = 100WPEP; V <sub>CE</sub> = 12.5 V; I <sub>CQ</sub> = 150 mA	—	—	-30	dBc
C <sub>OB</sub>	f = 1 MHz; V <sub>CB</sub> = 12.5 V	—	400	—	pF

Note: 1. f = 30 + 30.001MHz

## TYPICAL PERFORMANCE

Figure 3. Power Gain &amp; Collector Efficiency vs Power Input

Figure 4. IMD vs Power Output, P<sub>ep</sub>

Figure 5. Power Output vs Power Input

Table 6. Impedance Data <sup>(1)</sup>

FREQ.	Z <sub>IN</sub> (Ω)	Z <sub>CL</sub> (Ω)
30 MHz	0.57 + j 0.78	0.80 + j 0.43

Note: 1. P<sub>OUT</sub> = 100 W PEP; V<sub>CE</sub> = 12.5 V

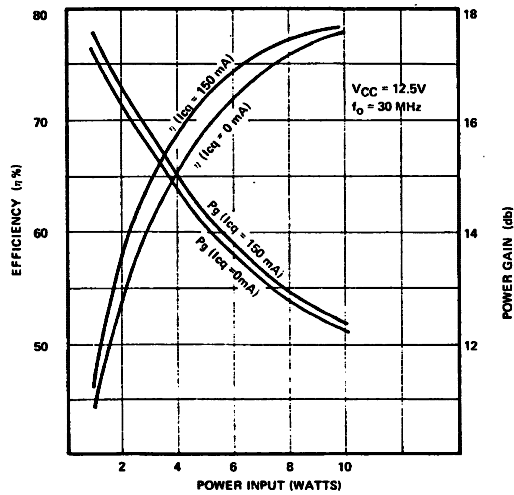
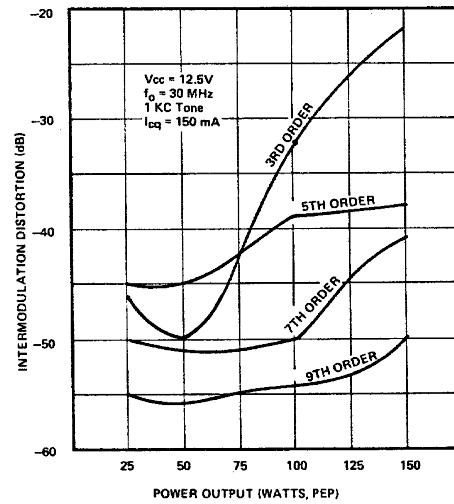
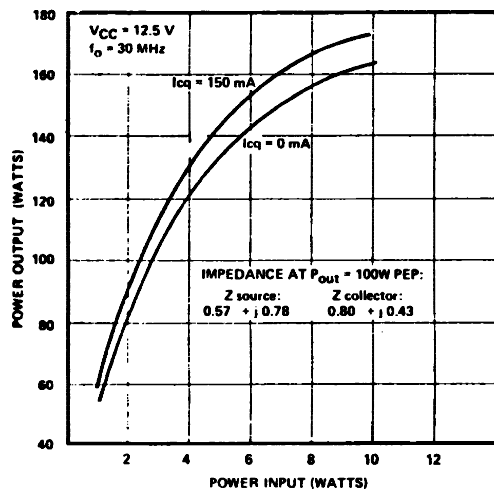
## TEST CIRCUIT

Figure 6. Test Circuit

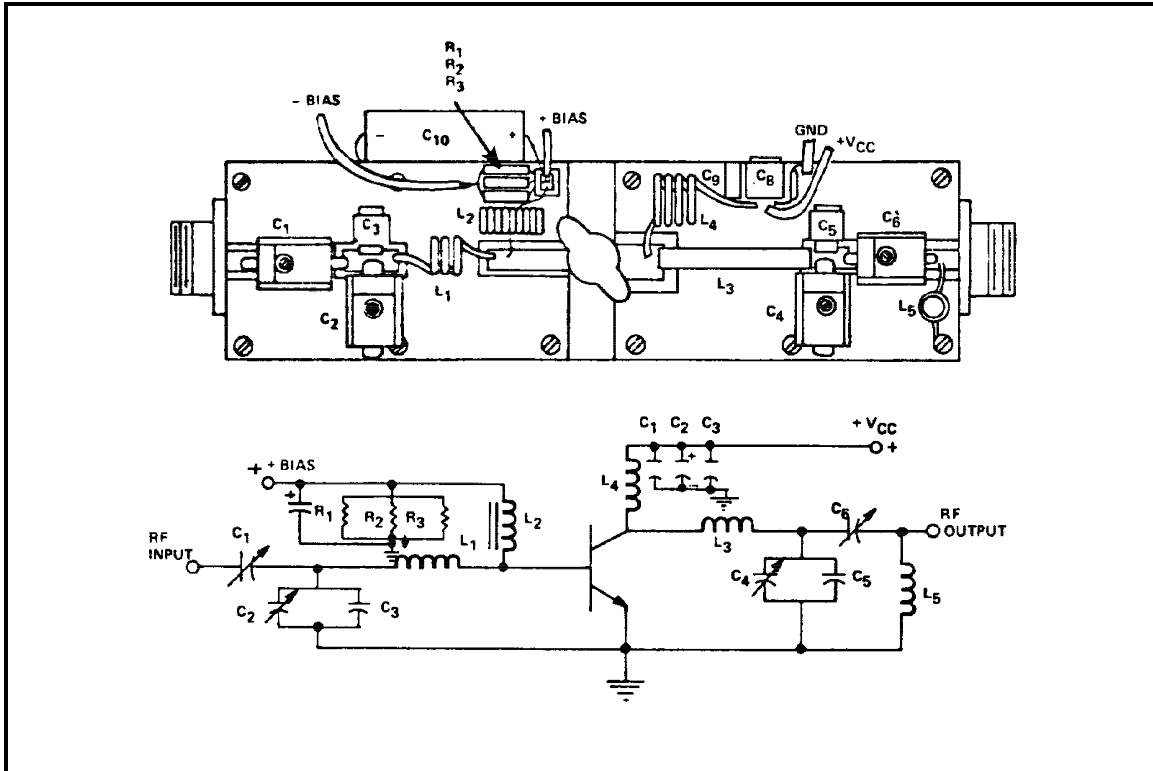

Table 7. Test Circuit

C1	9 - 180pF Arco 463
C2	5 - 380pF Arco 465
C3	200pF Arco 465
C4, C6	170pF Arco 469
C7	0.1 $\mu$ F Ceramic Disc
C5, C8	1000pF Unelco
C9	10 $\mu$ F Electrolytic, 35Vdc
C10	1000 $\mu$ F Electrolytic, 35Vdc
L1	2 1/2 Turns, #14 AWG, I.D. Loose Wound
L2	16 Turns, #16 AWG, Enameled Wire on Micrometals Torroid #T-94
L3	Copper Strap 1/4" Widht, Length 1 1/2, Height 1/2"
L4	4 Turns, #16 AWG, Enameled Wire 3/8" I.D.
L5	5 Turns, #18 AWG on 1/4" I.D. Coil Form Length 1/2", Ferrite Slug
R1, R2, R3	1.5 Ohm, 1 Watt Carbon

## PACKAGE MECHANICAL

Table 8. M174 Mechanical Data

Symbol	millimeters			inches		
	Min	Typ	Max	Min	Typ	Max
A	5.59		5.84	0.220		0.230
B		3.18			0.125	
C	6.22		6.48	0.245		0.255
D	18.28		18.54	0.720		0.730
E		3.18			0.125	
F	24.64		24.89	0.970		0.980
G	12.57		12.83	0.495		0.505
H	0.08		0.18	0.003		0.007
I	2.29		2.79	0.090		0.110
J	4.06		4.45	0.160		0.175
K			7.11			0.280
L			26.67			1.050

Figure 7. M174 Package Dimensions

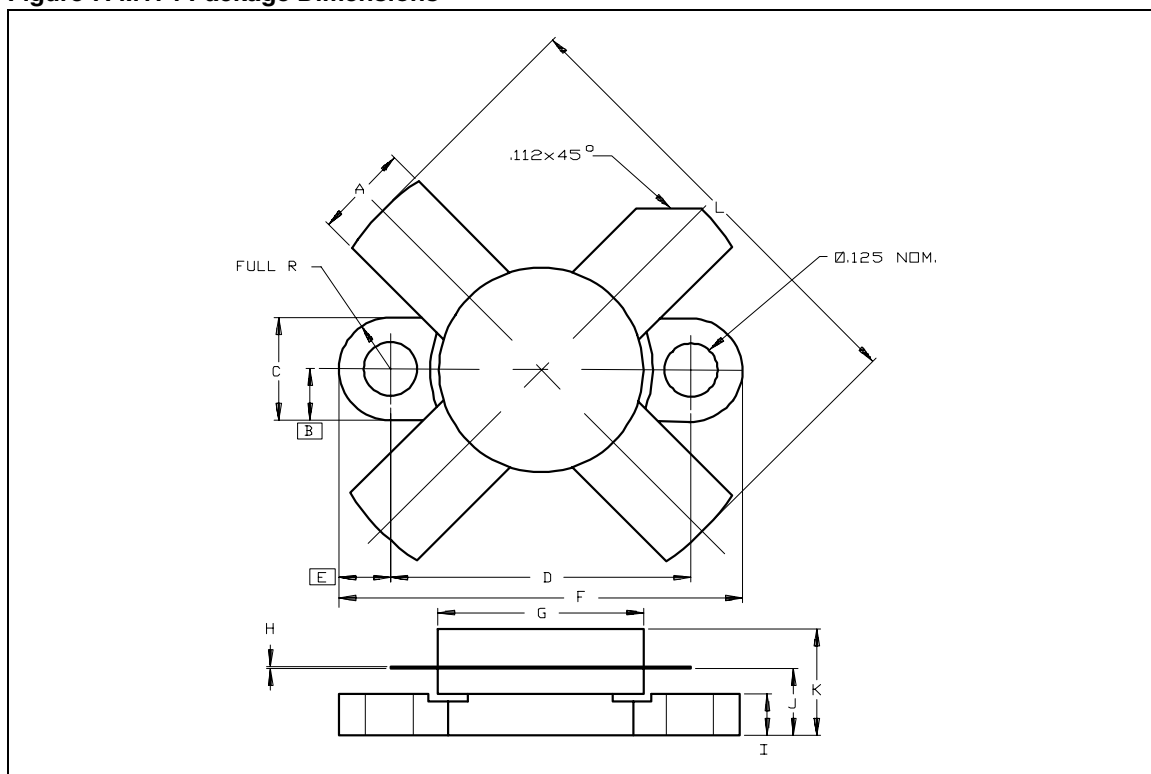

Note: Drawing is not to scale.

**REVISION HISTORY**

**Table 9. Revision History**

<b>Date</b>	<b>Revision</b>	<b>Description of Changes</b>
November-1992	1	First Issue
7-June-2004	2	Stylesheet update. No content change.

Information furnished is believed to be accurate and reliable. However, STMicroelectronics assumes no responsibility for the consequences of use of such information nor for any infringement of patents or other rights of third parties which may result from its use. No license is granted by implication or otherwise under any patent or patent rights of STMicroelectronics. Specifications mentioned in this publication are subject to change without notice. This publication supersedes and replaces all information previously supplied. STMicroelectronics products are not authorized for use as critical components in life support devices or systems without express written approval of STMicroelectronics.

The ST logo is a registered trademark of STMicroelectronics.  
All other names are the property of their respective owners

© 2004 STMicroelectronics - All rights reserved

STMicroelectronics GROUP OF COMPANIES

Australia - Belgium - Brazil - Canada - China - Czech Republic - Finland - France - Germany - Hong Kong - India - Israel - Italy - Japan -  
Malaysia - Malta - Morocco - Singapore - Spain - Sweden - Switzerland - United Kingdom - United States

[www.st.com](http://www.st.com)

