



# NPN SILICON GERMANIUM RF TRANSISTOR

# NESG270034

## NPN SiGe RF TRANSISTOR FOR MEDIUM OUTPUT POWER AMPLIFICATION (2 W) 3-PIN POWER MINIMOLD (34 PKG)

### FEATURES

- This product is suitable for medium output power (2 W) amplification
  - $P_{out} = 33.5 \text{ dBm TYP. @ } V_{CE} = 6 \text{ V, } P_{in} = 20 \text{ dBm, } f = 460 \text{ MHz}$
  - $P_{out} = 31.5 \text{ dBm TYP. @ } V_{CE} = 6 \text{ V, } P_{in} = 20 \text{ dBm, } f = 900 \text{ MHz}$
- Using UHS2-HV process (SiGe technology),  $V_{CBO}$  (ABSOLUTE MAXIMUM RATINGS) = 25 V
- 3-pin power minimold (34 PKG)

### ORDERING INFORMATION

Part Number	Order Number	Package	Quantity	Supplying Form
NESG270034	NESG270034-AZ	3-pin power minimold (34 PKG) (Pb-Free) <sup>Note</sup>	25 pcs (Non reel)	• Magazine case
NESG270034-T1	NESG270034-T1-AZ		1 kpcs/reel	• 12 mm wide embossed taping • Pin 2 (Emitter) face the perforation side of the tape

<R> **Note** Contains Lead in the part except the electrode terminals.

**Remark** To order evaluation samples, contact your nearby sales office.  
Unit sample quantity is 25 pcs.

### ABSOLUTE MAXIMUM RATINGS ( $T_A = +25^\circ\text{C}$ )

Parameter	Symbol	Ratings	Unit
Collector to Base Voltage	$V_{CBO}$	25	V
Collector to Emitter Voltage	$V_{CEO}$	9.2	V
Emitter to Base Voltage	$V_{EBO}$	2.8	V
Collector Current	$I_c$	750	mA
Total Power Dissipation	$P_{tot}$ <sup>Note</sup>	1.9	W
Junction Temperature	$T_j$	150	$^\circ\text{C}$
Storage Temperature	$T_{stg}$	-65 to +150	$^\circ\text{C}$

**Note** Mounted on  $34.2 \text{ cm}^2 \times 0.8 \text{ mm}$  (t) glass epoxy PWB

**Caution** Observe precautions when handling because these devices are sensitive to electrostatic discharge.

The information in this document is subject to change without notice. Before using this document, please confirm that this is the latest version.

**THERMAL RESISTANCE (T<sub>A</sub> = +25°C)**

Parameter	Symbol	Ratings	Unit
Thermal Resistance from Junction to Ambient <sup>Note</sup>	R <sub>thj-a</sub>	65	°C/W

**Note** Mounted on 34.2 cm<sup>2</sup> × 0.8 mm (t) glass epoxy PWB

**RECOMMENDED OPERATING RANGE (T<sub>A</sub> = +25°C)**

Parameter	Symbol	MIN.	TYP.	MAX.	Unit
Collector to Emitter Voltage	V <sub>CE</sub>	–	6.0	7.2	V
Collector Current	I <sub>c</sub>	–	600	750	mA
Input Power <sup>Note</sup>	P <sub>in</sub>	–	20	23	dBm

**Note** Input power under conditions of V<sub>CE</sub> ≤ 6.0 V, f = 460 MHz

ELECTRICAL CHARACTERISTICS (T<sub>A</sub> = +25°C)

Parameter	Symbol	Test Conditions	MIN.	TYP.	MAX.	Unit
DC Characteristics						
Collector Cut-off Current	I <sub>CBO</sub>	V <sub>CB</sub> = 9.2 V, I <sub>E</sub> = 0 mA	–	–	1	μA
Emitter Cut-off Current	I <sub>EBO</sub>	V <sub>EB</sub> = 1.0 V, I <sub>C</sub> = 0 mA	–	–	1	μA
DC Current Gain	h <sub>FE</sub> <sup>Note</sup>	V <sub>CE</sub> = 3 V, I <sub>C</sub> = 100 mA	80	120	180	–
RF Characteristics						
Linear Gain (1)	G <sub>L</sub>	V <sub>CE</sub> = 6 V, I <sub>C (set)</sub> = 30 mA (RF OFF), f = 460 MHz, P <sub>in</sub> = 0 dBm	17.5	19.5	–	dB
Linear Gain (2)	G <sub>L</sub>	V <sub>CE</sub> = 6 V, I <sub>C (set)</sub> = 30 mA (RF OFF), f = 900 MHz, P <sub>in</sub> = 0 dBm	–	15	–	dB
Output Power (1)	P <sub>out</sub>	V <sub>CE</sub> = 6 V, I <sub>C (set)</sub> = 30 mA (RF OFF), f = 460 MHz, P <sub>in</sub> = 20 dBm	31.5	33.5	–	dBm
Output Power (2)	P <sub>out</sub>	V <sub>CE</sub> = 6 V, I <sub>C (set)</sub> = 30 mA (RF OFF), f = 900 MHz, P <sub>in</sub> = 20 dBm	–	31.5	–	dBm
Collector Efficiency (1)	η <sub>C</sub>	V <sub>CE</sub> = 6 V, I <sub>C (set)</sub> = 30 mA (RF OFF), f = 460 MHz, P <sub>in</sub> = 20 dBm	–	60	–	%
Collector Efficiency (2)	η <sub>C</sub>	V <sub>CE</sub> = 6 V, I <sub>C (set)</sub> = 30 mA (RF OFF), f = 900 MHz, P <sub>in</sub> = 20 dBm	–	50	–	%

**Note** Pulse measurement: PW ≤ 350 μs, Duty Cycle ≤ 2%

h<sub>FE</sub> CLASSIFICATION

Rank	FB
Marking	SQ
h <sub>FE</sub> Value	80 to 180

<R> TYPICAL CHARACTERISTICS (T<sub>A</sub> = +25°C, unless otherwise specified)

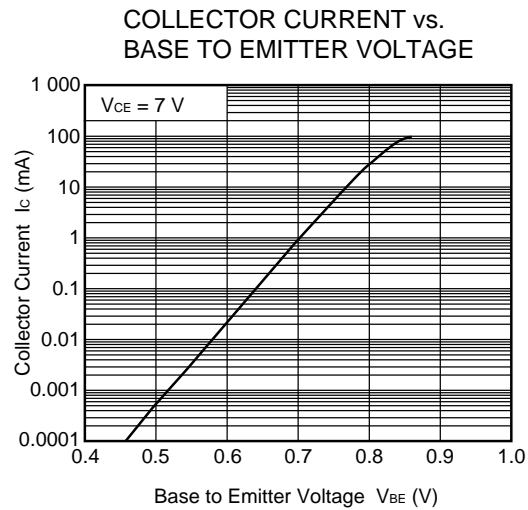
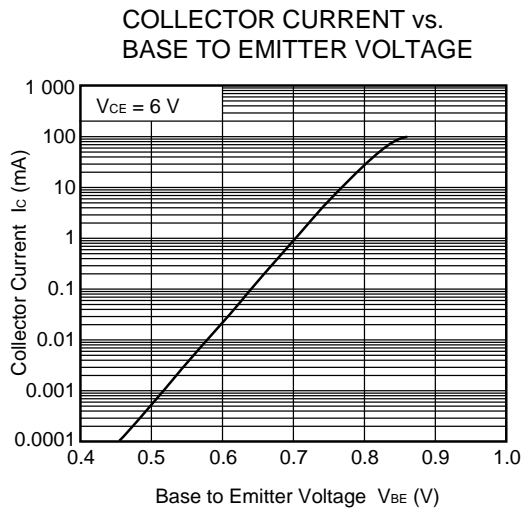
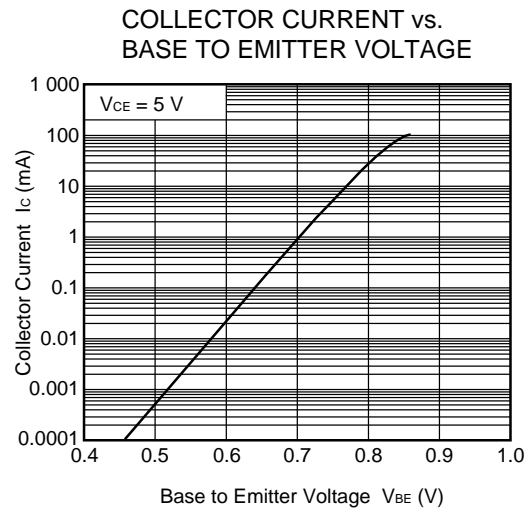
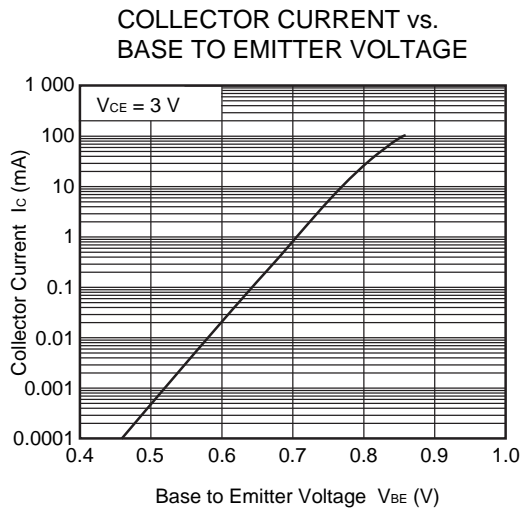
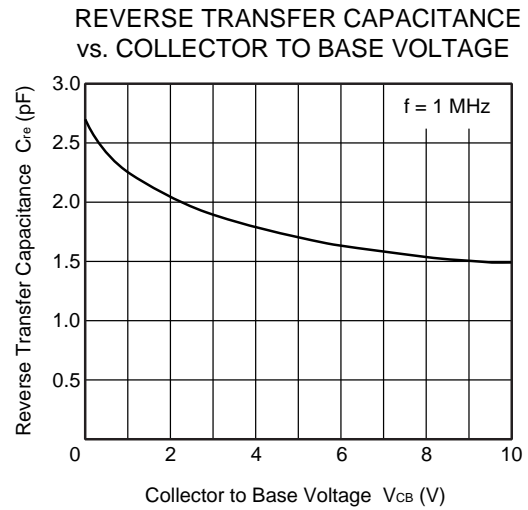
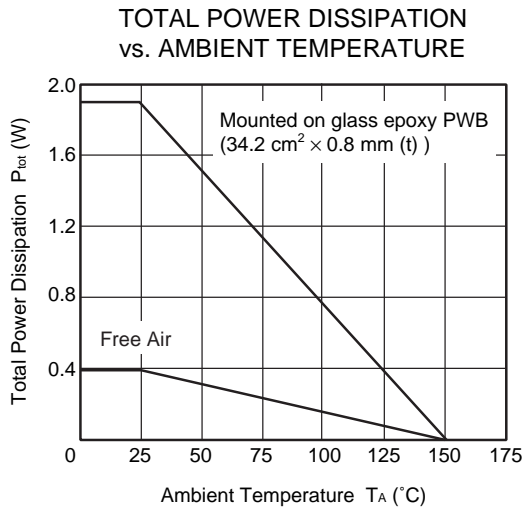

**Remark** The graph indicates nominal characteristics.

COLLECTOR CURRENT vs. COLLECTOR TO EMITTER VOLTAGE

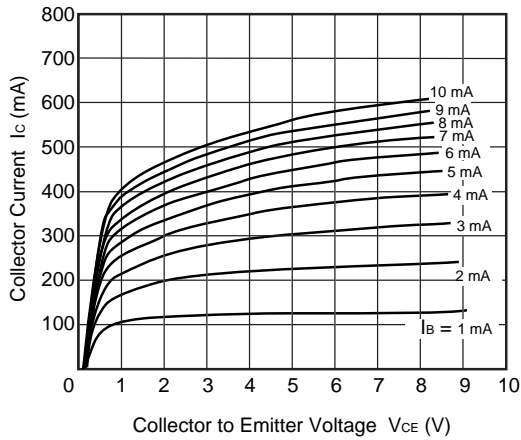

DC CURRENT GAIN vs. COLLECTOR CURRENT

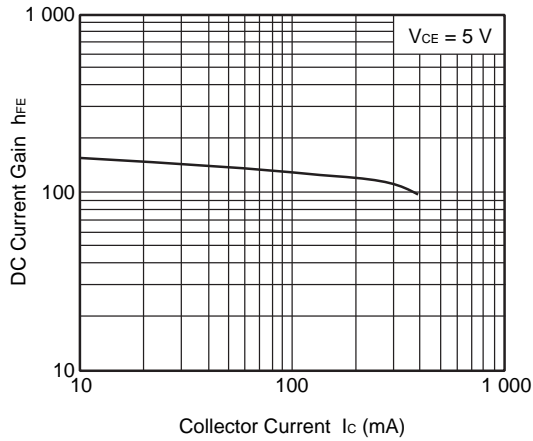

DC CURRENT GAIN vs. COLLECTOR CURRENT

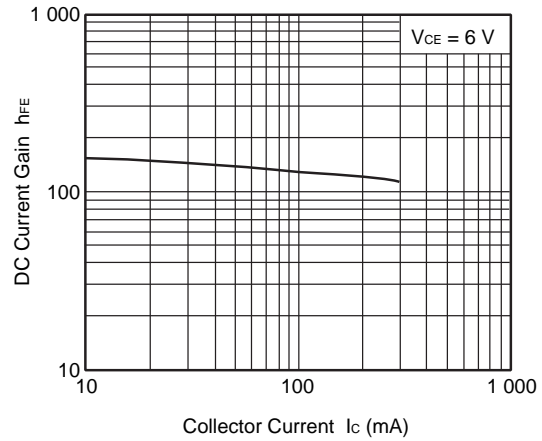

DC CURRENT GAIN vs. COLLECTOR CURRENT

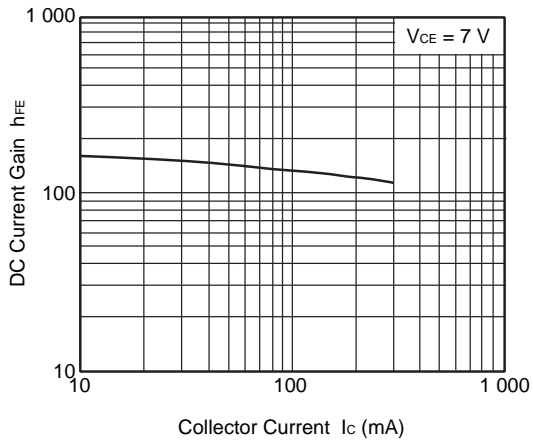

GAIN BANDWIDTH PRODUCT vs. COLLECTOR CURRENT

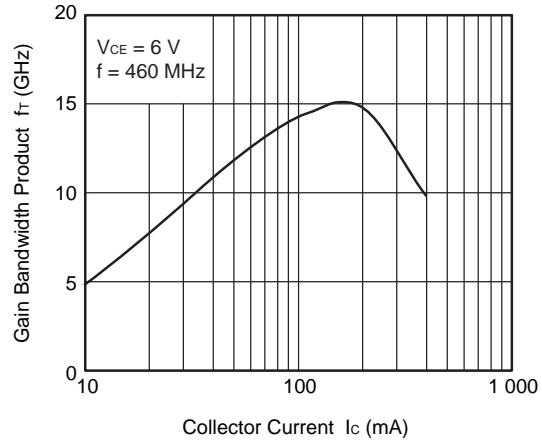

**Remark** The graph indicates nominal characteristics.

INSERTION POWER GAIN, MAG, MSG vs. FREQUENCY

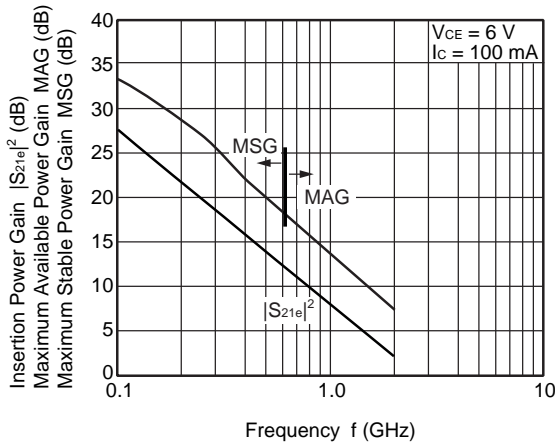

INSERTION POWER GAIN, MAG, MSG vs. FREQUENCY

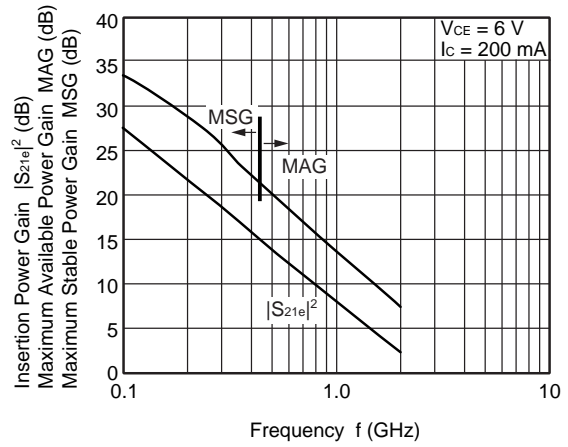

INSERTION POWER GAIN, MAG, MSG vs. FREQUENCY

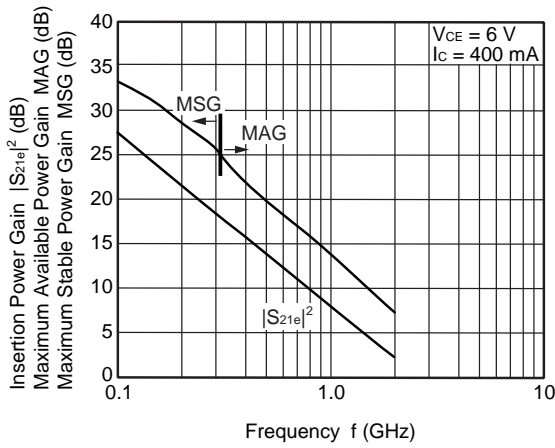

INSERTION POWER GAIN, MAG, MSG vs. COLLECTOR CURRENT

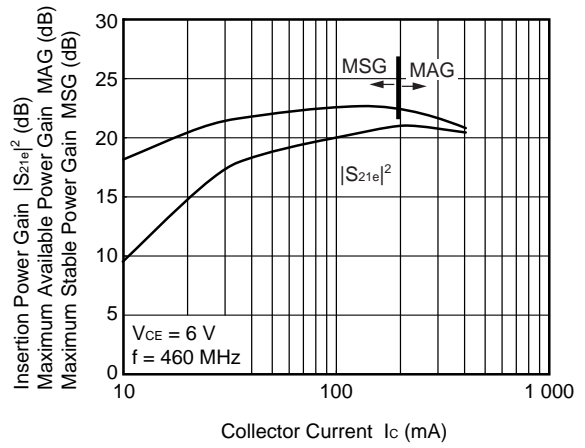

**Remark** The graph indicates nominal characteristics.

**S-PARAMETERS**

S-parameters/Noise parameters are provided on our web site in a form (S2P) that enables direct import to a microwave circuit simulator without keyboard input.

Click here to download S-parameters.

[RF and Microwave] → [Device Parameters]

URL <http://www.ncsd.necel.com/microwave/index.html>

**PA EVALUATION CIRCUIT TYPICAL CHARACTERISTICS**

OUTPUT POWER, COLLECTOR CURRENT, COLLECTOR EFFICIENCY vs. INPUT POWER

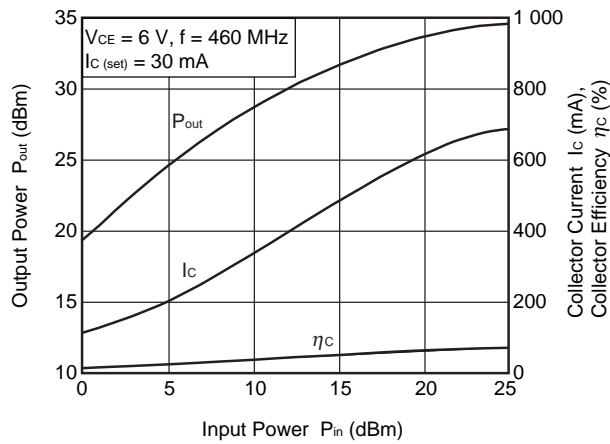

**Remark** The graph indicates nominal characteristics.

**EVALUATION CIRCUIT (f = 460 MHz)**

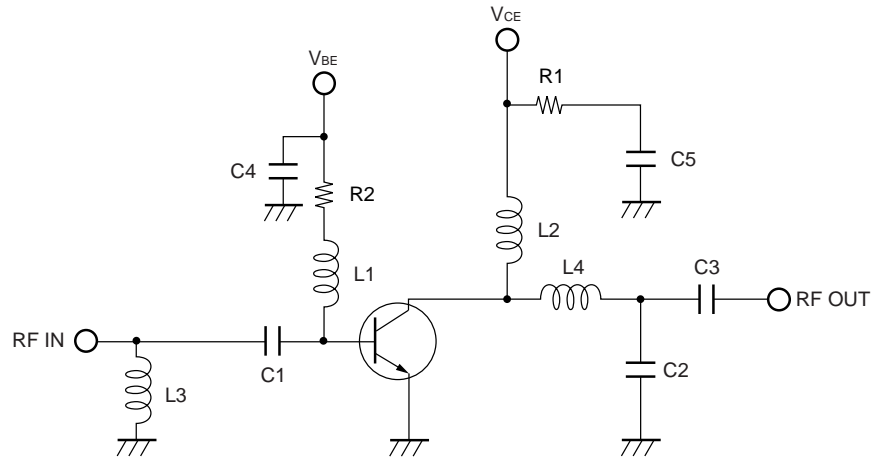

The application circuits and their parameters are for reference only and are not intended for use in actual design-ins.

**EVALUATION BOARD (f = 460 MHz)**

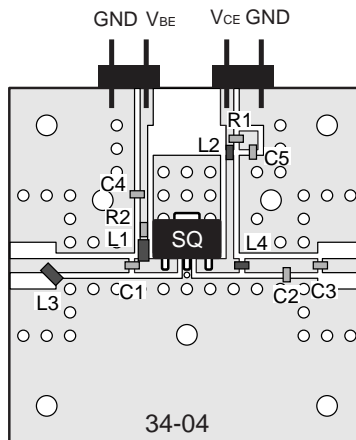

**Notes**

1. 38 × 38 mm, t = 0.8 mm double sided copper clad glass epoxy PWB.
2. Back side: GND pattern
3. Solder gold plated on pattern
4. ○: Through holes



## COMPONENT LIST

Component	Maker	Value	Size (TYPE)	Purpose
C1	Murata	11 pF	1005	Input DC Block/Input RF Matching
C2	Murata	9.5 pF	1005	Input RF Matching
C3	Murata	39 pF	1005	Input DC Block/Output RF Matching
C4	Murata	10 000 pF	1005	RF GND
C5	Murata	10 000 pF	1005	RF GND
L1	Toko	390 nH	2012	RF Block/Input RF Matching
L2	Toko	47 nH	1608	RF Block/Output RF Matching
L3	Toko	5.6 nH	2012	Input RF Matching
L4	Toko	5.1 nH	1608	Output RF Matching
R1	SSM	15 $\Omega$	1005	Improve Stability
R2	SSM	10 $\Omega$	1005	Improve Stability

**PACKAGE DIMENSIONS**

**3-PIN POWER MINIMOLD (34 PKG) (UNIT: mm)**

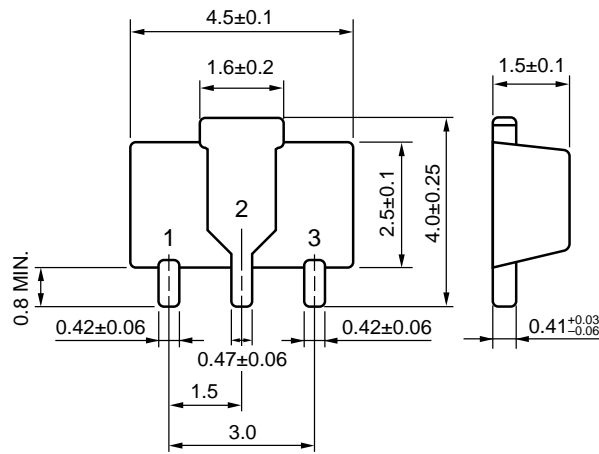

**PIN CONNECTIONS**

- 1. Collector
- 2. Emitter
- 3. Base

• **The information in this document is current as of December, 2007. The information is subject to change without notice. For actual design-in, refer to the latest publications of NEC Electronics data sheets or data books, etc., for the most up-to-date specifications of NEC Electronics products. Not all products and/or types are available in every country. Please check with an NEC Electronics sales representative for availability and additional information.**

• No part of this document may be copied or reproduced in any form or by any means without the prior written consent of NEC Electronics. NEC Electronics assumes no responsibility for any errors that may appear in this document.

• NEC Electronics does not assume any liability for infringement of patents, copyrights or other intellectual property rights of third parties by or arising from the use of NEC Electronics products listed in this document or any other liability arising from the use of such products. No license, express, implied or otherwise, is granted under any patents, copyrights or other intellectual property rights of NEC Electronics or others.

• Descriptions of circuits, software and other related information in this document are provided for illustrative purposes in semiconductor product operation and application examples. The incorporation of these circuits, software and information in the design of a customer's equipment shall be done under the full responsibility of the customer. NEC Electronics assumes no responsibility for any losses incurred by customers or third parties arising from the use of these circuits, software and information.

• While NEC Electronics endeavors to enhance the quality, reliability and safety of NEC Electronics products, customers agree and acknowledge that the possibility of defects thereof cannot be eliminated entirely. To minimize risks of damage to property or injury (including death) to persons arising from defects in NEC Electronics products, customers must incorporate sufficient safety measures in their design, such as redundancy, fire-containment and anti-failure features.

• NEC Electronics products are classified into the following three quality grades: "Standard", "Special" and "Specific".

The "Specific" quality grade applies only to NEC Electronics products developed based on a customer-designated "quality assurance program" for a specific application. The recommended applications of an NEC Electronics product depend on its quality grade, as indicated below. Customers must check the quality grade of each NEC Electronics product before using it in a particular application.

"Standard": Computers, office equipment, communications equipment, test and measurement equipment, audio and visual equipment, home electronic appliances, machine tools, personal electronic equipment and industrial robots.

"Special": Transportation equipment (automobiles, trains, ships, etc.), traffic control systems, anti-disaster systems, anti-crime systems, safety equipment and medical equipment (not specifically designed for life support).

"Specific": Aircraft, aerospace equipment, submersible repeaters, nuclear reactor control systems, life support systems and medical equipment for life support, etc.

The quality grade of NEC Electronics products is "Standard" unless otherwise expressly specified in NEC Electronics data sheets or data books, etc. If customers wish to use NEC Electronics products in applications not intended by NEC Electronics, they must contact an NEC Electronics sales representative in advance to determine NEC Electronics' willingness to support a given application.

(Note)

(1) "NEC Electronics" as used in this statement means NEC Electronics Corporation and also includes its majority-owned subsidiaries.

(2) "NEC Electronics products" means any product developed or manufactured by or for NEC Electronics (as defined above).