



# NPN EPITAXIAL SILICON TRANSISTOR HIGH FREQUENCY LOW DISTORTION AMPLIFIER

## NE856M02

### FEATURES

- **HIGH COLLECTOR CURRENT:**  
100 mA MAX
- **NEW HIGH GAIN POWER MINI-MOLD PACKAGE**  
(SOT-89 TYPE)
- **HIGH OUTPUT POWER AT 1 dB COMPRESSION:**  
22 dBm TYP at 1 GHz
- **HIGH IP<sub>3</sub>:**  
32 dBm TYP at 1 GHz

### DESCRIPTION

NEC's NE856M02 is an NPN silicon epitaxial bipolar transistor designed for medium power applications requiring high dynamic range and low intermodulation distortion. This device offers excellent performance and reliability at low cost through NEC's titanium, platinum, gold metallization system and direct nitride passivation of the surface of the chip. The NE856M02 is an excellent choice for low noise amplifiers in the VHF to UHF band and is suitable for CATV and other telecommunication applications.

### OUTLINE DIMENSIONS (Units in mm)

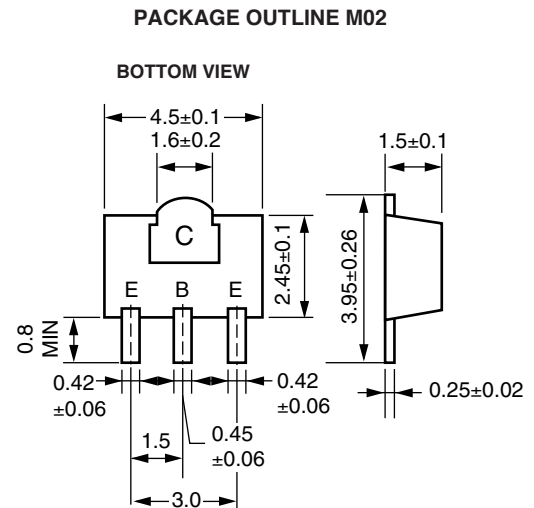

#### PIN CONNECTIONS

- E: Emitter
- C: Collector
- B: Base

### ELECTRICAL CHARACTERISTICS (T<sub>A</sub> = 25°C)

PART NUMBER EIAJ <sup>1</sup> REGISTERED NUMBER PACKAGE OUTLINE			NE856M02 2SC5336 M02		
SYMBOLS	PARAMETERS AND CONDITIONS	UNITS	MIN	TYP	MAX
I <sub>CBO</sub>	Collector Cutoff Current at V <sub>CB</sub> = 10 V, I <sub>E</sub> = 0	μA			1.0
I <sub>EBO</sub>	Emitter Cutoff Current at V <sub>EB</sub> = 1 V, I <sub>C</sub> = 0	μA			1.0
h <sub>FE</sub> <sup>2</sup>	DC Current Gain at V <sub>CE</sub> = 10 V, I <sub>C</sub> = 20 mA		50	120	250
f <sub>T</sub>	Gain Bandwidth Product at V <sub>CE</sub> = 10 V, I <sub>C</sub> = 20 mA	GHz		6.5	
C <sub>RE</sub> <sup>3</sup>	Feed-back Capacitance at V <sub>CB</sub> = 10 V, I <sub>E</sub> = 0, f = 1.0 MHz	pF		0.5	0.8
IS <sub>21E</sub> <sup>12</sup>	Insertion Power Gain at V <sub>CE</sub> = 10 V, I <sub>C</sub> = 20 mA, f = 1 GHz	dB		12.0	
NF <sub>1</sub>	Noise Figure 1 at V <sub>CE</sub> = 10 V, I <sub>C</sub> = 7 mA, f = 1 GHz	dB		1.1	
NF <sub>2</sub>	Noise Figure 2 at V <sub>CE</sub> = 10 V, I <sub>C</sub> = 40 mA, f = 1 GHz	dB		1.8	3.0

#### Notes:

1. Electronic Industrial Association of Japan.
2. Pulsed measurement, pulse width ≤ 350 μs, duty cycle ≤ 2 %.
3. The emitter terminal should be connected to the ground terminal of the 3 terminal capacitance bridge.

**ABSOLUTE MAXIMUM RATINGS<sup>1</sup>** (T<sub>A</sub> = 25°C)

SYMBOLS	PARAMETERS	UNITS	RATINGS
V <sub>CBO</sub>	Collector to Base Voltage	V	20
V <sub>CEO</sub>	Collector to Emitter Voltage	V	12
V <sub>EB0</sub>	Emitter to Base Voltage	V	3.0
I <sub>C</sub>	Collector Current	mA	100
P <sub>T</sub>	Total Power Dissipation <sup>2</sup>	W	1.2
T <sub>J</sub>	Junction Temperature	°C	150
T <sub>STG</sub>	Storage Temperature	°C	-65 to +150

Notes:

1. Operation in excess of any one of these parameters may result in permanent damage.
2. Device mounted on 0.7 mm X 16 cm<sup>2</sup> double-sided ceramic substrate (copper plating).

**TYPICAL PERFORMANCE CURVES** (T<sub>A</sub> = 25°C)

**TOTAL POWER DISSIPATION vs. AMBIENT TEMPERATURE**

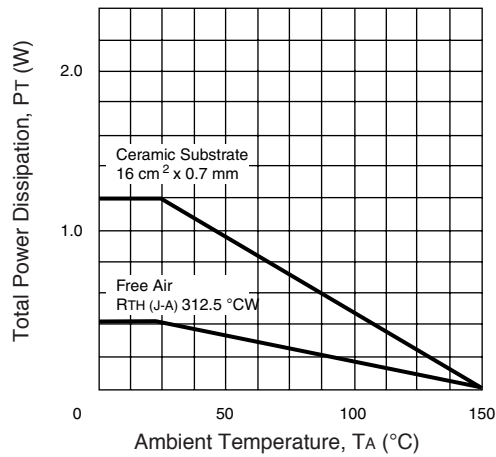

**FEED BACK CAPACITANCE vs. COLLECTOR TO BASE VOLTAGE**

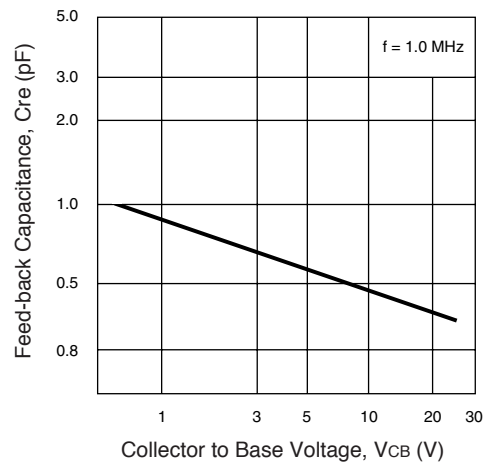

**DC CURRENT GAIN vs. COLLECTOR CURRENT**

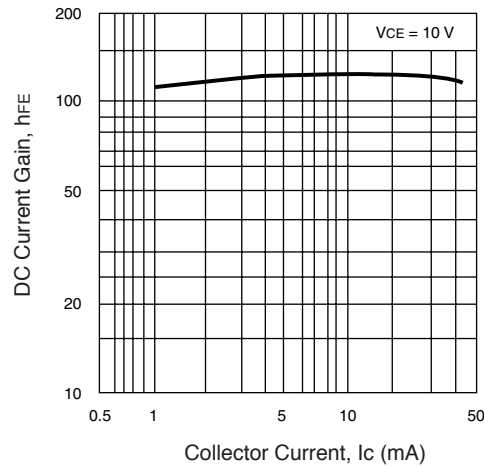

**INSERTION GAIN vs. COLLECTOR CURRENT**

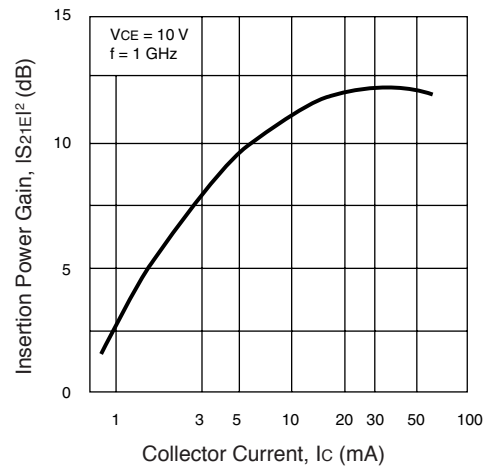

**ORDERING INFORMATION**

PART NUMBER	QUANTITY	PACKAGING
NE856M02-T1-AZ	1000	Tape & Reel

## TYPICAL PERFORMANCE CURVES (TA = 25°C)

### GAIN BAND WIDTH PRODUCT vs. COLLECTOR CURRENT

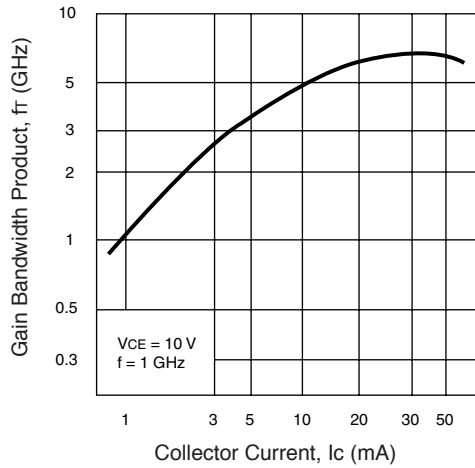

### INSERTION GAIN AND MAXIMUM GAIN vs. FREQUENCY

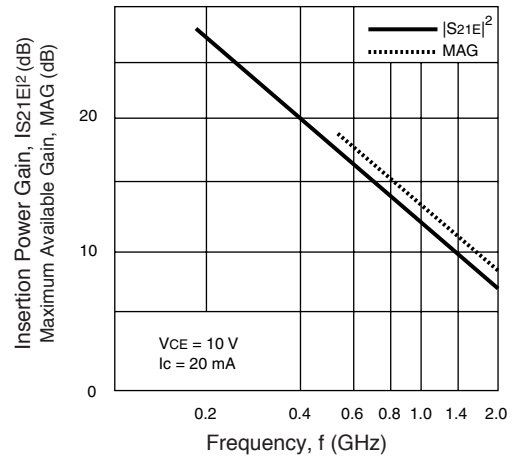

### NOISE FIGURE vs. COLLECTOR CURRENT

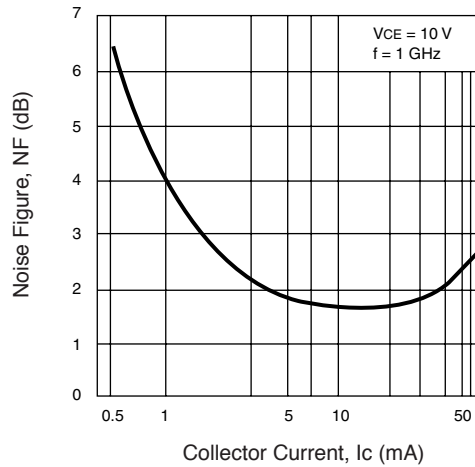

### INTERMODULATION DISTORTION vs. COLLECTOR CURRENT

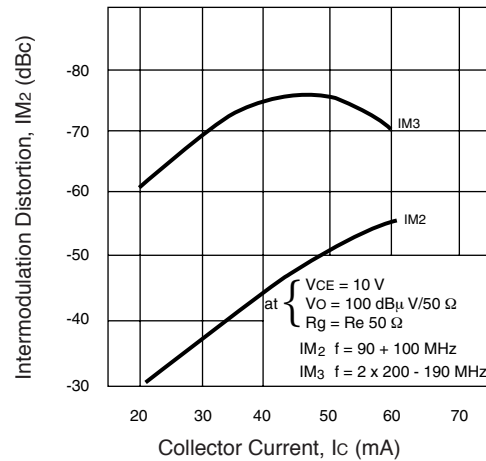

**TYPICAL COMMON EMITTER SCATTERING PARAMETERS** (TA = 25°C)

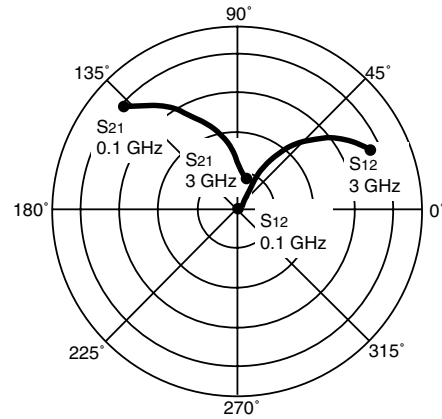
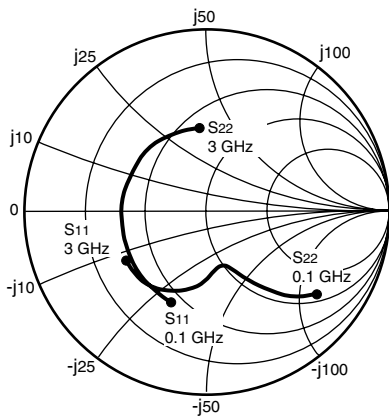

Coordinates in Ohms  
Frequency in GHz  
VCE = 3 V, IC = 10 mA

**NE856M02**  
VCE = 3 V, IC = 10 mA

FREQUENCY (GHz)	S11		S21		S12		S22		K	MAG (dB)
	MAG	ANG	MAG	ANG	MAG	ANG	MAG	ANG		
0.100	0.626	-67.5	20.474	137.7	0.031	60.2	0.766	-36.6	0.26	28.2
0.200	0.535	-110.6	14.152	115.2	0.044	50.4	0.541	-52.5	0.47	25.1
0.400	0.479	-149.7	7.982	94.8	0.059	50.0	0.366	-63.4	0.77	21.3
0.600	0.465	-168.7	5.464	83.6	0.073	53.3	0.316	-68.4	0.94	18.7
0.800	0.461	178.6	4.146	75.2	0.089	55.6	0.306	-72.9	1.03	15.7
1.000	0.459	168.7	3.339	68.0	0.104	56.7	0.311	-77.1	1.08	13.3
1.200	0.458	160.4	2.800	61.5	0.121	56.9	0.323	-81.0	1.10	11.7
1.400	0.458	152.9	2.415	55.5	0.138	56.7	0.340	-84.8	1.11	10.5
1.600	0.457	146.0	2.127	49.9	0.155	55.8	0.358	-88.1	1.10	9.4
1.800	0.458	139.5	1.905	44.6	0.171	54.8	0.376	-91.4	1.10	8.6
2.000	0.457	133.2	1.728	39.5	0.188	53.5	0.394	-94.3	1.08	7.9
2.200	0.457	127.0	1.582	34.7	0.205	51.9	0.412	-97.1	1.07	7.2
2.400	0.458	121.2	1.464	30.2	0.222	50.2	0.428	-99.7	1.05	6.8
2.600	0.459	115.4	1.363	26.0	0.239	48.6	0.442	-102.2	1.04	6.3
2.800	0.460	109.7	1.278	21.9	0.256	46.6	0.455	-104.8	1.02	6.0
3.000	0.462	103.9	1.204	17.9	0.272	44.5	0.466	-107.4	1.01	5.7

Note:

1. Gain Calculation:

$$MAG = \frac{|S_{21}|}{|S_{12}|} (K \pm \sqrt{K^2 - 1}). \text{ When } K \leq 1, \text{ MAG is undefined and MSG values are used. } MSG = \frac{|S_{21}|}{|S_{12}|}, K = \frac{1 + |\Delta|^2 - |S_{11}|^2 - |S_{22}|^2}{2 |S_{12} S_{21}|}, \Delta = S_{11} S_{22} - S_{21} S_{12}$$

MAG = Maximum Available Gain

MSG = Maximum Stable Gain

## TYPICAL COMMON EMITTER SCATTERING PARAMETERS (T<sub>A</sub> = 25°C)

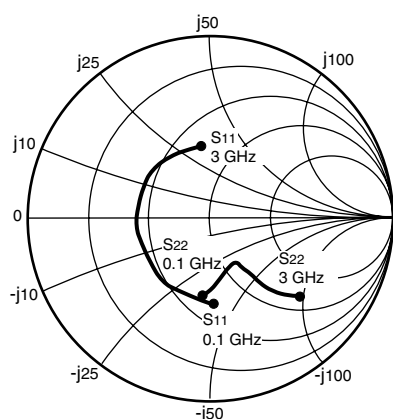

Coordinates in Ohms  
Frequency in GHz  
V<sub>CE</sub> = 5 V, I<sub>c</sub> = 20 mA

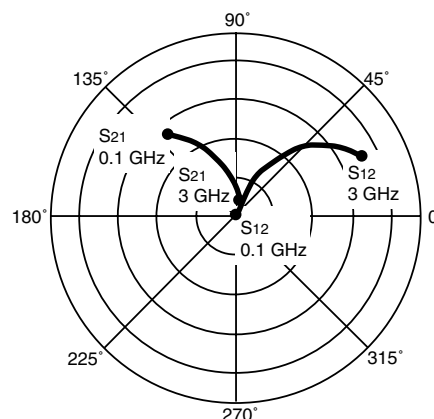

### NE856M02

V<sub>CE</sub> = 5 V, I<sub>c</sub> = 20 mA

FREQUENCY (GHz)	S <sub>11</sub>		S <sub>21</sub>		S <sub>12</sub>		S <sub>22</sub>		K	MAG (dB)
	MAG	ANG	MAG	ANG	MAG	ANG	MAG	ANG		
0.100	0.481	-88.5	28.679	129.0	0.023	57.9	0.664	-41.3	0.42	31.0
0.200	0.434	-130.1	17.703	108.4	0.031	56.9	0.445	-52.9	0.68	27.5
0.400	0.414	-162.4	9.494	91.4	0.048	62.0	0.311	-58.6	0.92	22.9
0.600	0.411	-178.1	6.428	81.9	0.066	64.1	0.280	-62.1	1.02	19.1
0.800	0.410	171.0	4.855	74.4	0.084	65.0	0.280	-66.4	1.05	16.2
1.000	0.410	162.2	3.900	67.9	0.101	64.4	0.290	-70.7	1.07	14.2
1.200	0.409	154.5	3.265	61.9	0.120	63.2	0.305	-74.9	1.07	12.7
1.400	0.409	147.5	2.810	56.3	0.137	61.8	0.323	-79.0	1.07	11.4
1.600	0.408	140.9	2.471	51.0	0.154	60.0	0.343	-82.5	1.07	10.4
1.800	0.407	134.6	2.208	45.9	0.172	58.2	0.362	-85.9	1.06	9.6
2.000	0.406	128.6	2.000	41.1	0.188	56.2	0.381	-88.8	1.05	8.9
2.200	0.406	122.7	1.829	36.4	0.205	54.1	0.399	-91.7	1.04	8.3
2.400	0.406	117.0	1.689	32.0	0.222	52.0	0.416	-94.4	1.03	7.8
2.600	0.406	111.4	1.571	27.7	0.238	49.8	0.431	-96.9	1.02	7.4
2.800	0.408	105.9	1.471	23.7	0.253	47.6	0.445	-99.4	1.01	7.1
3.000	0.409	100.4	1.384	19.7	0.268	45.3	0.457	-101.9	1.00	7.1

Note:

1. Gain Calculation:

$$\text{MAG} = \frac{|S_{21}|}{|S_{12}|} \left( K \pm \sqrt{K^2 - 1} \right). \text{ When } K \leq 1, \text{ MAG is undefined and MSG values are used. } \text{MSG} = \frac{|S_{21}|}{|S_{12}|}, K = \frac{1 + |\Delta|^2 - |S_{11}|^2 - |S_{22}|^2}{2 |S_{12} S_{21}|}, \Delta = S_{11} S_{22} - S_{21} S_{12}$$

MAG = Maximum Available Gain

MSG = Maximum Stable Gain

**TYPICAL COMMON EMITTER SCATTERING PARAMETERS** (T<sub>A</sub> = 25°C)

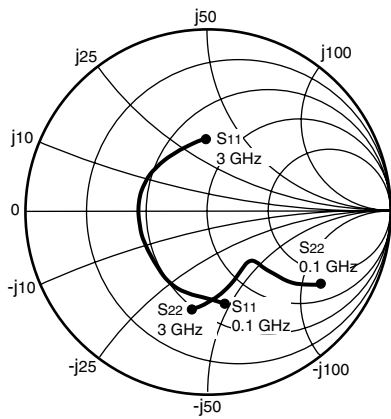

Coordinates in Ohms  
Frequency in GHz  
V<sub>CE</sub> = 10 V, I<sub>c</sub> = 20 mA

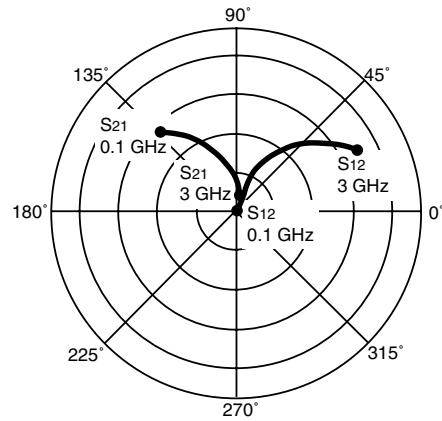

**NE856M02**

V<sub>CE</sub> = 10 V, I<sub>c</sub> = 20 mA

FREQUENCY (GHz)	S <sub>11</sub>		S <sub>21</sub>		S <sub>12</sub>		S <sub>22</sub>		K	MAG (dB)
	MAG	ANG	MAG	ANG	MAG	ANG	MAG	ANG		
0.100	0.508	-78.9	29.606	131.4	0.019	57.0	0.707	-34.0	0.43	32.0
0.200	0.425	-120.5	18.715	110.2	0.029	57.5	0.500	-42.7	0.65	28.1
0.400	0.384	-156.2	10.140	92.5	0.043	62.1	0.373	-45.9	0.91	23.7
0.600	0.376	-173.7	6.875	82.6	0.058	64.6	0.347	-48.9	1.01	20.0
0.800	0.374	174.4	5.192	75.0	0.074	65.4	0.346	-53.4	1.05	17.1
1.000	0.374	164.9	4.168	68.3	0.090	65.3	0.356	-58.2	1.07	15.0
1.200	0.375	156.8	3.481	62.2	0.106	64.5	0.370	-63.0	1.07	13.5
1.400	0.375	149.5	2.990	56.6	0.122	63.4	0.387	-67.7	1.07	12.3
1.600	0.375	142.7	2.620	51.2	0.137	61.9	0.406	-71.9	1.06	11.3
1.800	0.376	136.2	2.337	46.1	0.153	60.3	0.424	-75.9	1.05	10.4
2.000	0.377	130.1	2.109	41.2	0.168	58.6	0.443	-79.4	1.04	9.7
2.200	0.378	123.9	1.922	36.5	0.183	56.8	0.461	-82.9	1.03	9.2
2.400	0.380	118.2	1.770	32.1	0.198	54.8	0.478	-85.9	1.01	8.9
2.600	0.382	112.6	1.640	27.8	0.213	53.2	0.494	-88.8	0.99	8.9
2.800	0.385	107.0	1.531	23.7	0.227	51.1	0.508	-91.7	0.98	8.3
3.000	0.388	101.4	1.435	19.8	0.242	49.1	0.521	-94.5	0.97	7.7

Note:

1. Gain Calculation:

$$MAG = \frac{|S_{21}|}{|S_{12}|} (K \pm \sqrt{K^2 - 1}). \text{ When } K \leq 1, \text{ MAG is undefined and MSG values are used. } MSG = \frac{|S_{21}|}{|S_{12}|}, K = \frac{1 + |\Delta|^2 - |S_{11}|^2 - |S_{22}|^2}{2 |S_{12} S_{21}|}, \Delta = S_{11} S_{22} - S_{21} S_{12}$$

MAG = Maximum Available Gain

MSG = Maximum Stable Gain

## TYPICAL COMMON EMITTER SCATTERING PARAMETERS (T<sub>A</sub> = 25°C)

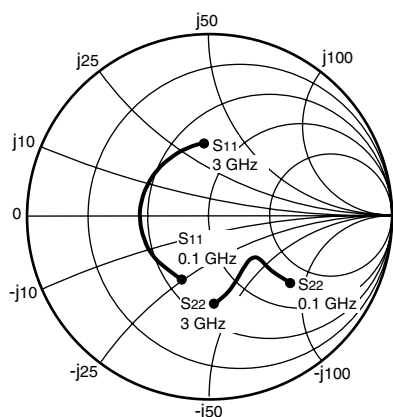

Coordinates in Ohms  
Frequency in GHz  
V<sub>CE</sub> = 10 V, I<sub>c</sub> = 50 mA

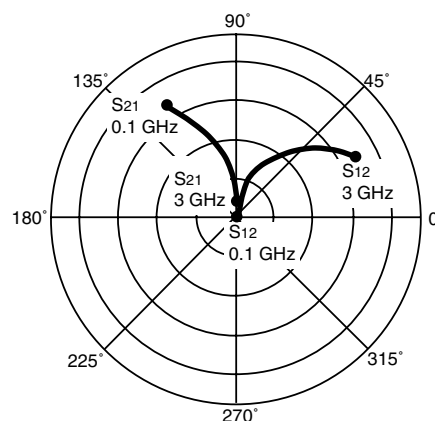

### NE856M02

V<sub>CE</sub> = 10 V, I<sub>c</sub> = 50 mA

FREQUENCY (GHz)	S <sub>11</sub>		S <sub>21</sub>		S <sub>12</sub>		S <sub>22</sub>		K	MAG (dB)
	MAG	ANG	MAG	ANG	MAG	ANG	MAG	ANG		
0.100	0.388	-113.0	35.396	119.8	0.015	64.1	0.569	-38.2	0.60	33.7
0.200	0.380	-147.3	20.013	102.2	0.023	66.1	0.399	-40.5	0.85	29.4
0.400	0.377	-172.1	10.398	88.1	0.040	70.5	0.325	-41.0	1.00	23.7
0.600	0.378	175.4	6.989	79.6	0.057	71.3	0.316	-44.8	1.05	19.5
0.800	0.379	166.1	5.262	72.7	0.075	71.0	0.324	-50.2	1.06	16.9
1.000	0.380	158.2	4.218	66.5	0.092	69.4	0.337	-55.9	1.07	15.1
1.200	0.381	151.2	3.521	60.7	0.109	67.8	0.354	-61.1	1.06	13.6
1.400	0.382	144.7	3.023	55.3	0.125	65.9	0.373	-66.2	1.06	12.4
1.600	0.381	138.5	2.650	50.1	0.141	64.0	0.393	-70.7	1.05	11.4
1.800	0.382	132.5	2.362	45.1	0.157	62.0	0.412	-74.9	1.04	10.6
2.000	0.383	126.8	2.132	40.2	0.173	59.9	0.432	-78.6	1.03	9.9
2.200	0.383	121.0	1.943	35.6	0.188	57.7	0.451	-82.1	1.01	9.4
2.400	0.385	115.6	1.789	31.2	0.203	55.6	0.468	-85.3	1.00	9.5
2.600	0.386	110.2	1.657	27.0	0.218	53.6	0.485	-88.3	0.98	8.8
2.800	0.389	104.8	1.547	22.9	0.232	51.3	0.500	-91.2	0.97	8.2
3.000	0.392	99.5	1.450	19.0	0.246	49.3	0.513	-94.0	0.96	7.7

Note:

1. Gain Calculation:

$$\text{MAG} = \frac{|S_{21}|}{|S_{12}|} \left( K \pm \sqrt{K^2 - 1} \right). \text{ When } K \leq 1, \text{ MAG is undefined and MSG values are used. } \text{MSG} = \frac{|S_{21}|}{|S_{12}|}, K = \frac{1 + |\Delta|^2 - |S_{11}|^2 - |S_{22}|^2}{2 |S_{12} S_{21}|}, \Delta = S_{11} S_{22} - S_{21} S_{12}$$

MAG = Maximum Available Gain

MSG = Maximum Stable Gain

#### Life Support Applications

These NEC products are not intended for use in life support devices, appliances, or systems where the malfunction of these products can reasonably be expected to result in personal injury. The customers of CEL using or selling these products for use in such applications do so at their own risk and agree to fully indemnify CEL for all damages resulting from such improper use or sale.

EXCLUSIVE NORTH AMERICAN AGENT FOR NEC RF, MICROWAVE & OPTOELECTRONIC SEMICONDUCTORS

**CEL** CALIFORNIA EASTERN LABORATORIES • Headquarters • 4590 Patrick Henry Drive • Santa Clara, CA 95054-1817 • (408) 988-3500 • Telex 34-6393 • FAX (408) 988-0279  
DATA SUBJECT TO CHANGE WITHOUT NOTICE

Internet: <http://WWW.CEL.COM>

11/14/2001

Subject: Compliance with EU Directives

CEL certifies, to its knowledge, that semiconductor and laser products detailed below are compliant with the requirements of European Union (EU) Directive 2002/95/EC Restriction on Use of Hazardous Substances in electrical and electronic equipment (RoHS) and the requirements of EU Directive 2003/11/EC Restriction on Penta and Octa BDE.

CEL Pb-free products have the same base part number with a suffix added. The suffix –A indicates that the device is Pb-free. The –AZ suffix is used to designate devices containing Pb which are exempted from the requirement of RoHS directive (\*). In all cases the devices have Pb-free terminals. All devices with these suffixes meet the requirements of the RoHS directive.

This status is based on CEL’s understanding of the EU Directives and knowledge of the materials that go into its products as of the date of disclosure of this information.

Restricted Substance per RoHS	Concentration Limit per RoHS (values are not yet fixed)	Concentration contained in CEL devices	
		-A	-AZ
Lead (Pb)	< 1000 PPM	Not Detected	(*)
Mercury	< 1000 PPM	Not Detected	
Cadmium	< 100 PPM	Not Detected	
Hexavalent Chromium	< 1000 PPM	Not Detected	
PBB	< 1000 PPM	Not Detected	
PBDE	< 1000 PPM	Not Detected	

If you should have any additional questions regarding our devices and compliance to environmental standards, please do not hesitate to contact your local representative.

Important Information and Disclaimer: Information provided by CEL on its website or in other communications concerning the substance content of its products represents knowledge and belief as of the date that it is provided. CEL bases its knowledge and belief on information provided by third parties and makes no representation or warranty as to the accuracy of such information. Efforts are underway to better integrate information from third parties. CEL has taken and continues to take reasonable steps to provide representative and accurate information but may not have conducted destructive testing or chemical analysis on incoming materials and chemicals. CEL and CEL suppliers consider certain information to be proprietary, and thus CAS numbers and other limited information may not be available for release.

In no event shall CEL’s liability arising out of such information exceed the total purchase price of the CEL part(s) at issue sold by CEL to customer on an annual basis.

See CEL Terms and Conditions for additional clarification of warranties and liability.