



RF Power Field Effect Transistors

N-Channel Enhancement-Mode Lateral MOSFETs

RF Power transistors designed for applications operating at frequencies between 960 and 1215 MHz. These devices are suitable for use in pulsed applications.

- Typical Pulsed Performance: $V_{DD} = 50$ Volts, $I_{DQ} = 200$ mA, Pulsed Width = 128 μ sec, Duty Cycle = 10%

| Application | P_{out} (W) | f (MHz) | G_{ps} (dB) | η_D (%) |
|-------------|---------------|----------|---------------|--------------|
| Narrowband | 500 Peak | 1030 | 19.7 | 62.0 |
| Broadband | 500 Peak | 960-1215 | 18.5 | 57.0 |

- Capable of Handling 10:1 VSWR, @ 50 Vdc, 1030 MHz, 500 Watts Peak Power

Features

- Characterized with Series Equivalent Large-Signal Impedance Parameters
- Internally Matched for Ease of Use
- Qualified Up to a Maximum of 50 V_{DD} Operation
- Integrated ESD Protection
- Greater Negative Gate-Source Voltage Range for Improved Class C Operation
- RoHS Compliant
- In Tape and Reel. R3 Suffix = 250 Units per 56 mm, 13 inch Reel.

MRF6V12500HR3
MRF6V12500HSR3

960-1215 MHz, 500 W, 50 V
PULSED
LATERAL N-CHANNEL
RF POWER MOSFETs

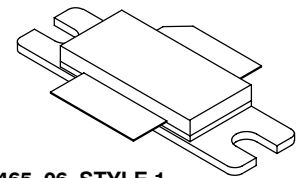

CASE 465-06, STYLE 1
NI-780
MRF6V12500HR3

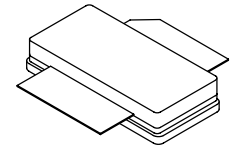

CASE 465A-06, STYLE 1
NI-780S
MRF6V12500HSR3

Table 1. Maximum Ratings

| Rating | Symbol | Value | Unit |
|--------------------------------------|-----------|-------------|--------------|
| Drain-Source Voltage | V_{DSS} | -0.5, +110 | Vdc |
| Gate-Source Voltage | V_{GS} | -6.0, +10 | Vdc |
| Storage Temperature Range | T_{stg} | -65 to +150 | $^{\circ}$ C |
| Case Operating Temperature | T_C | 150 | $^{\circ}$ C |
| Operating Junction Temperature (1,2) | T_J | 225 | $^{\circ}$ C |

Table 2. Thermal Characteristics

| Characteristic | Symbol | Value (2,3) | Unit |
|---|-----------------|-------------|----------------|
| Thermal Resistance, Junction to Case Case Temperature 80 $^{\circ}$ C, 500 W Pulsed, 128 μ sec Pulse Width, 10% Duty Cycle | $Z_{\theta JC}$ | 0.044 | $^{\circ}$ C/W |

- Continuous use at maximum temperature will affect MTTF.
- MTTF calculator available at <http://www.freescale.com/rf>. Select Software & Tools/Development Tools/Calculators to access MTTF calculators by product.
- Refer to AN1955, *Thermal Measurement Methodology of RF Power Amplifiers*. Go to <http://www.freescale.com/rf>. Select Documentation/Application Notes - AN1955.

Table 3. ESD Protection Characteristics

| Test Methodology | Class |
|---------------------------------------|--------------|
| Human Body Model (per JESD22-A114) | 2 (Minimum) |
| Machine Model (per EIA/JESD22-A115) | B (Minimum) |
| Charge Device Model (per JESD22-C101) | IV (Minimum) |

Table 4. Electrical Characteristics ($T_A = 25^\circ\text{C}$ unless otherwise noted)

| Characteristic | Symbol | Min | Typ | Max | Unit |
|----------------|--------|-----|-----|-----|------|
|----------------|--------|-----|-----|-----|------|

Off Characteristics

| | | | | | |
|---|---------------|-----|---|-----|-----------------|
| Gate-Source Leakage Current ($V_{GS} = 5\text{ Vdc}$, $V_{DS} = 0\text{ Vdc}$) | I_{GSS} | — | — | 10 | μAdc |
| Drain-Source Breakdown Voltage ($V_{GS} = 0\text{ Vdc}$, $I_D = 200\text{ mA}$) | $V_{(BR)DSS}$ | 110 | — | — | Vdc |
| Zero Gate Voltage Drain Leakage Current ($V_{DS} = 50\text{ Vdc}$, $V_{GS} = 0\text{ Vdc}$) | I_{DSS} | — | — | 20 | μAdc |
| Zero Gate Voltage Drain Leakage Current ($V_{DS} = 90\text{ Vdc}$, $V_{GS} = 0\text{ Vdc}$) | I_{DSS} | — | — | 200 | μAdc |

On Characteristics

| | | | | | |
|---|--------------|-----|------|-----|-----|
| Gate Threshold Voltage ($V_{DS} = 10\text{ Vdc}$, $I_D = 1.32\text{ mA}$) | $V_{GS(th)}$ | 0.9 | 1.7 | 2.4 | Vdc |
| Gate Quiescent Voltage ($V_{DD} = 50\text{ Vdc}$, $I_D = 200\text{ mA}$, Measured in Functional Test) | $V_{GS(Q)}$ | 1.7 | 2.4 | 3.2 | Vdc |
| Drain-Source On-Voltage ($V_{GS} = 10\text{ Vdc}$, $I_D = 3.26\text{ Adc}$) | $V_{DS(on)}$ | — | 0.25 | — | Vdc |

Dynamic Characteristics (1)

| | | | | | |
|---|-----------|---|------|---|----|
| Reverse Transfer Capacitance ($V_{DS} = 50\text{ Vdc} \pm 30\text{ mV(rms)ac}$ @ 1 MHz, $V_{GS} = 0\text{ Vdc}$) | C_{rss} | — | 0.2 | — | pF |
| Output Capacitance ($V_{DS} = 50\text{ Vdc} \pm 30\text{ mV(rms)ac}$ @ 1 MHz, $V_{GS} = 0\text{ Vdc}$) | C_{oss} | — | 697 | — | pF |
| Input Capacitance ($V_{DS} = 50\text{ Vdc}$, $V_{GS} = 0\text{ Vdc} \pm 30\text{ mV(rms)ac}$ @ 1 MHz) | C_{iss} | — | 1391 | — | pF |

Functional Tests (In Freescale Narrowband Test Fixture, 50 ohm system) $V_{DD} = 50\text{ Vdc}$, $I_{DQ} = 200\text{ mA}$, $P_{out} = 500\text{ W Peak}$ (50 W Avg.), $f = 1030\text{ MHz}$, Pulsed, 128 μsec Pulse Width, 10% Duty Cycle

| | | | | | |
|-------------------|----------|------|------|------|----|
| Power Gain | G_{ps} | 18.5 | 19.7 | 22.0 | dB |
| Drain Efficiency | η_D | 58.0 | 62.0 | — | % |
| Input Return Loss | IRL | — | -18 | -9 | dB |

Typical Broadband Performance — 960-1215 MHz (In Freescale 960-1215 MHz Test Fixture, 50 ohm system) $V_{DD} = 50\text{ Vdc}$, $I_{DQ} = 200\text{ mA}$, $P_{out} = 500\text{ W Peak}$ (50 W Avg.), $f = 960\text{-}1215\text{ MHz}$, Pulsed, 128 μsec Pulse Width, 10% Duty Cycle

| | | | | | |
|------------------|----------|---|------|---|----|
| Power Gain | G_{ps} | — | 18.5 | — | dB |
| Drain Efficiency | η_D | — | 57.0 | — | % |

1. Part internally matched both on input and output.

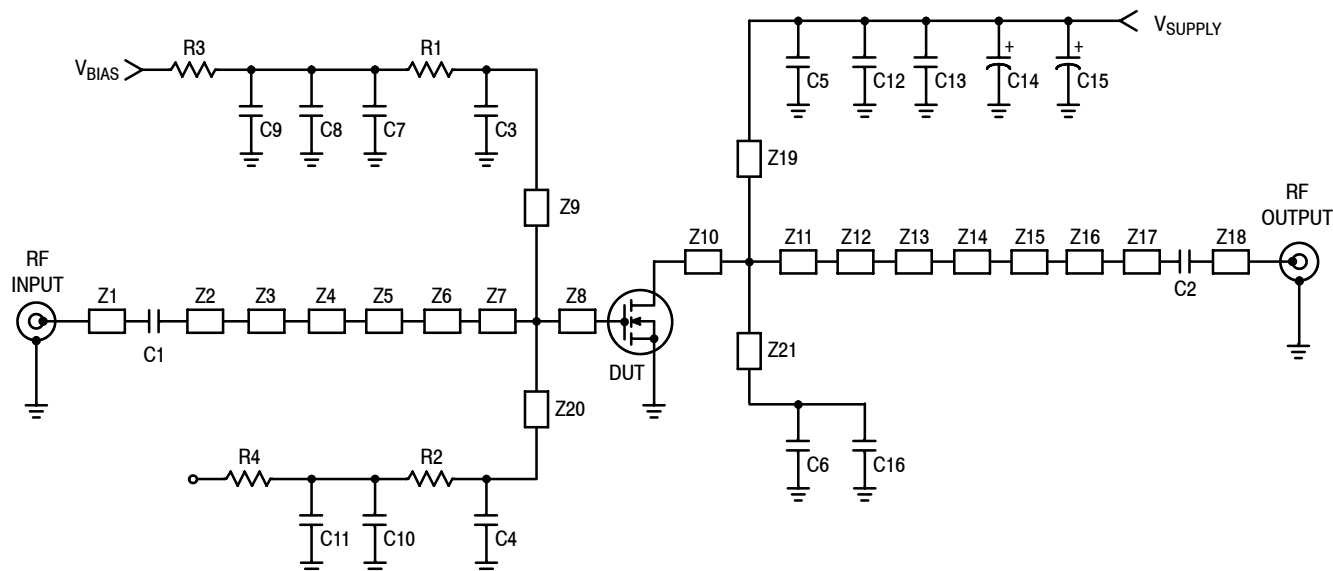

| | | | |
|---------|----------------------------|----------|--|
| Z1 | 0.457" x 0.080" Microstrip | Z11 | 0.161" x 1.500" Microstrip |
| Z2 | 0.250" x 0.080" Microstrip | Z12 | 0.613" x 1.281" Microstrip |
| Z3 | 0.605" x 0.040" Microstrip | Z13 | 0.248" x 0.865" Microstrip |
| Z4 | 0.080" x 0.449" Microstrip | Z14 | 0.087" x 0.425" Microstrip |
| Z5 | 0.374" x 0.608" Microstrip | Z15 | 0.309" x 0.090" Microstrip |
| Z6 | 0.118" x 1.252" Microstrip | Z16 | 0.193" x 0.516" Microstrip |
| Z7 | 0.778" x 1.710" Microstrip | Z17 | 0.279" x 0.080" Microstrip |
| Z8 | 0.095" x 1.710" Microstrip | Z18 | 0.731" x 0.080" Microstrip |
| Z9, Z20 | 0.482" x 0.050" Microstrip | Z19, Z21 | 0.507" x 0.040" Microstrip |
| Z10 | 0.138" x 1.500" Microstrip | PCB | Arlon CuClad 250GX-0300-55-22, 0.030", $\epsilon_r = 2.55$ |

Figure 1. MRF6V12500HR3(HSR3) Test Circuit Schematic

Table 5. MRF6V12500HR3(HSR3) Test Circuit Component Designations and Values

| Part | Description | Part Number | Manufacturer |
|-------------------|---|----------------------|--------------|
| C1, C2 | 5.1 pF Chip Capacitors | ATC100B5R1CT500XT | ATC |
| C3, C4, C5, C6 | 33 pF Chip Capacitors | ATC100B330JT500XT | ATC |
| C7, C10 | 10 μ F, 50 V Chip Capacitors | GRM55DR61H106KA88L | Murata |
| C8, C11, C13, C16 | 2.2 μ F, 100 V Chip Capacitors | 2225X7R225KT3AB | ATC |
| C9 | 22 μ F, 25 V Chip Capacitor | TPSD226M025R0200 | AVX |
| C12 | 1 μ F, 100 V Chip Capacitor | GRM31CR72A105KA01L | Murata |
| C14, C15 | 470 μ F, 63 V Electrolytic Capacitors | MCGPR63V477M13X26-RH | Multicomp |
| R1, R2 | 56 Ω , 1/4 W Chip Resistors | CRCW120656R0FKEA | Vishay |
| R3, R4 | 0 Ω , 3 A Chip Resistors | CRCW12060000Z0EA | Vishay |

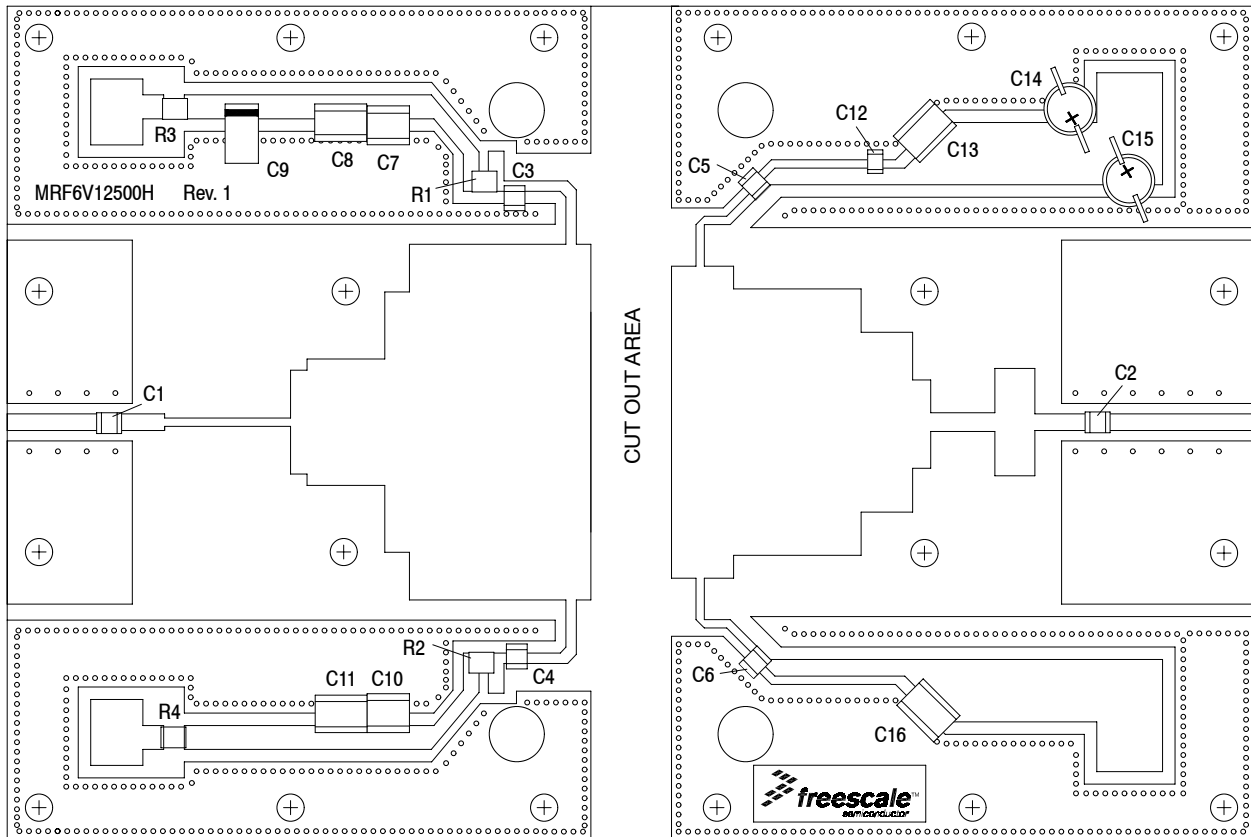

Figure 2. MRF6V12500HR3(HSR3) Test Circuit Component Layout

TYPICAL CHARACTERISTICS

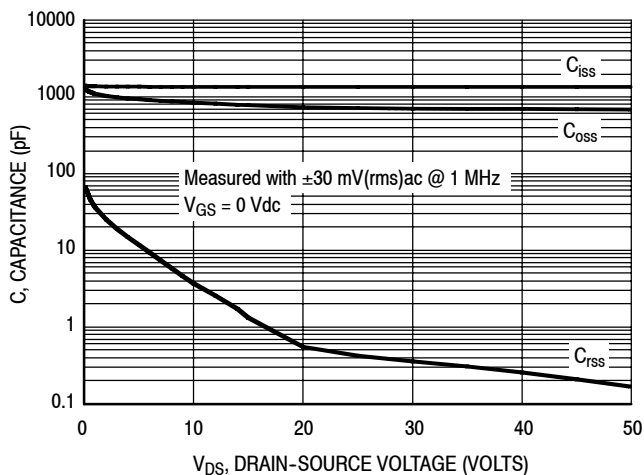

Figure 3. Capacitance versus Drain-Source Voltage

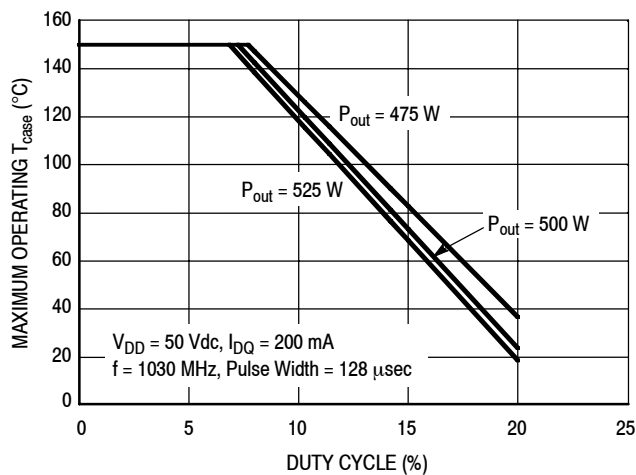

Figure 4. Safe Operating Area

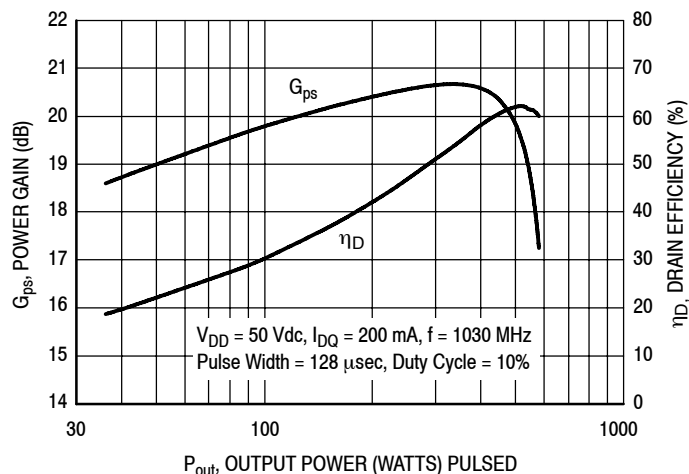

Figure 5. Pulsed Power Gain and Drain Efficiency versus Output Power

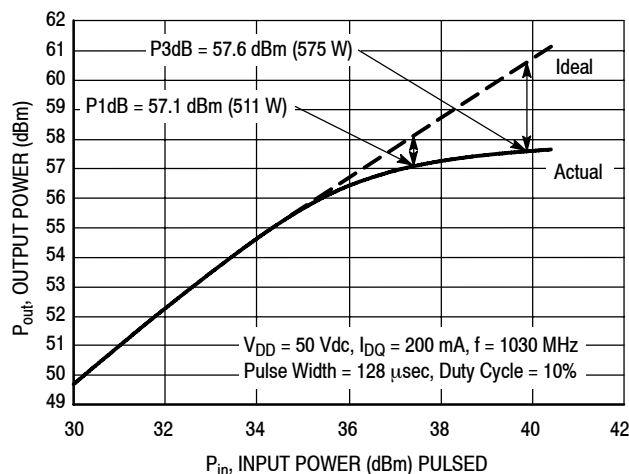

Figure 6. Pulsed Output Power versus Input Power

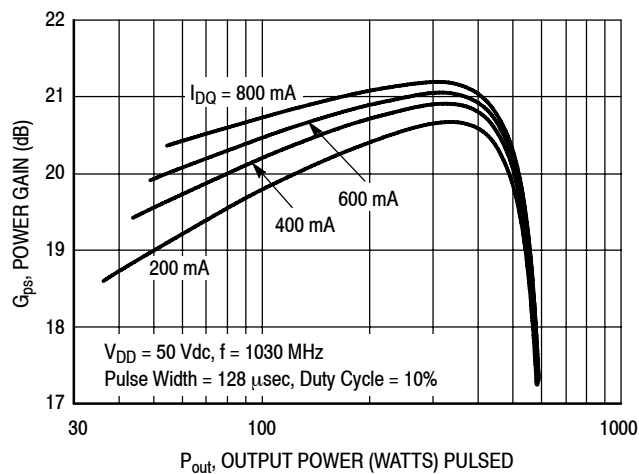

Figure 7. Pulsed Power Gain versus Output Power

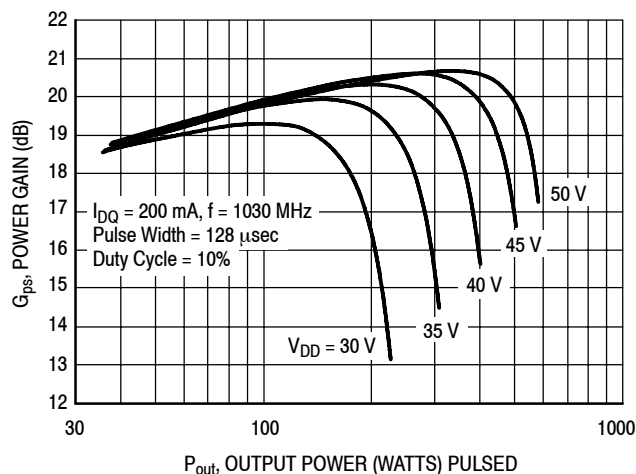

Figure 8. Pulsed Power Gain versus Output Power

TYPICAL CHARACTERISTICS

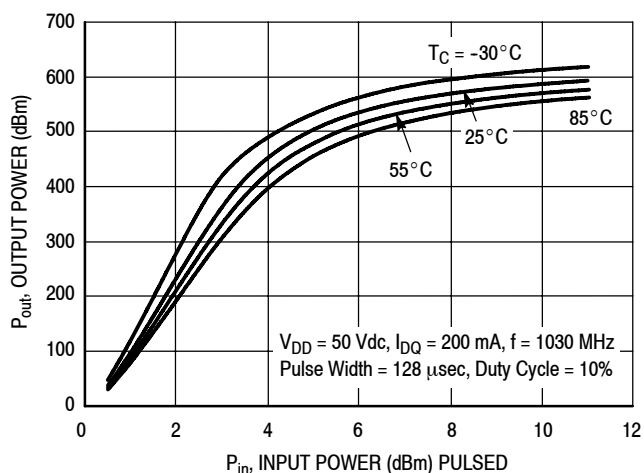

Figure 9. Pulsed Output Power versus Input Power

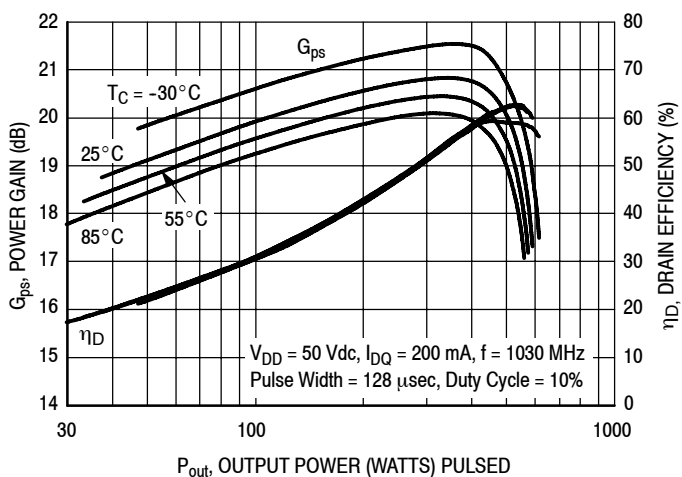
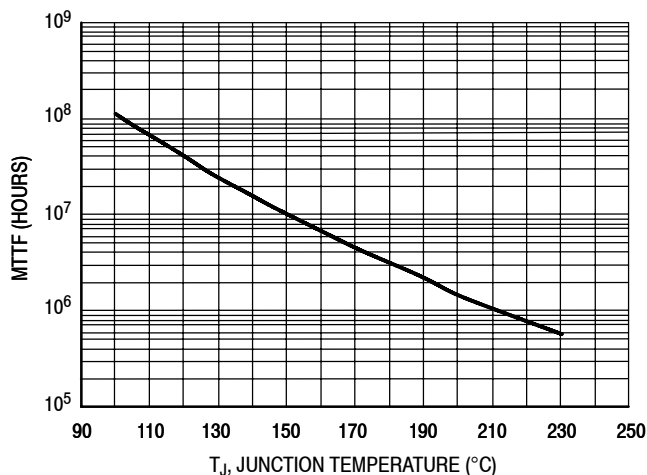

Figure 10. Pulsed Power Gain and Drain Efficiency versus Output Power



This above graph displays calculated MTTF in hours when the device is operated at $V_{DD} = 50$ Vdc, $P_{out} = 500$ W Peak, Pulse Width = 128 μ sec, Duty Cycle = 10%, and $\eta_D = 62\%$.

MTTF calculator available at <http://www.freescale.com/rf>. Select Software & Tools/Development Tools/Calculators to access MTTF calculators by product.

Figure 11. MTTF versus Junction Temperature

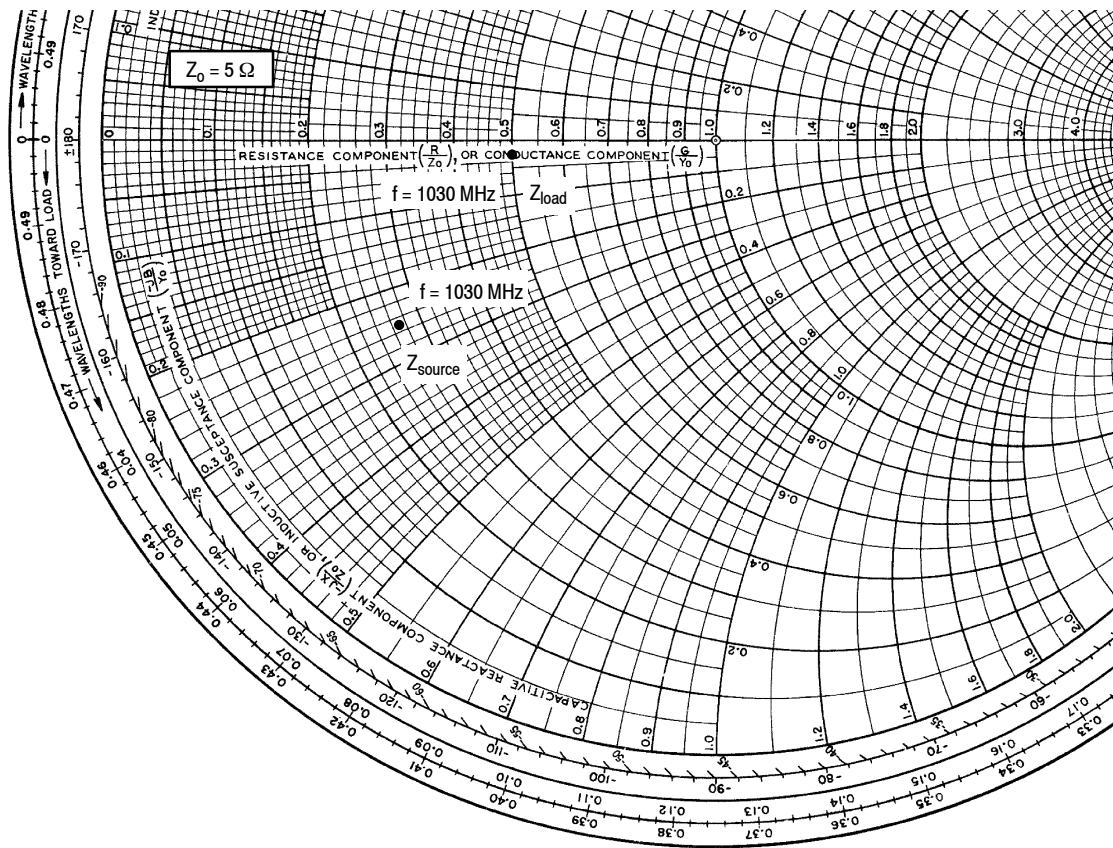

$V_{DD} = 50 \text{ Vdc}$, $I_{DQ} = 200 \text{ mA}$, $P_{out} = 500 \text{ W Peak}$

| f MHz | Z_{source} Ω | Z_{load} Ω |
|----------|-------------------|-----------------|
| 1030 | $1.36 - j1.27$ | $2.50 - j0.17$ |

Z_{source} = Test circuit impedance as measured from gate to ground.

Z_{load} = Test circuit impedance as measured from drain to ground.

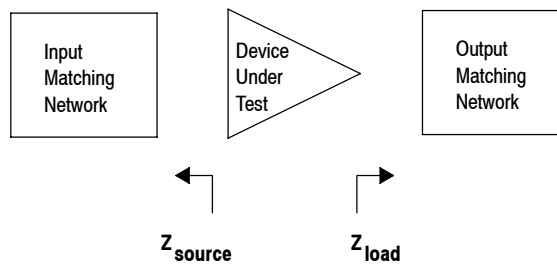

Figure 12. Series Equivalent Source and Load Impedance

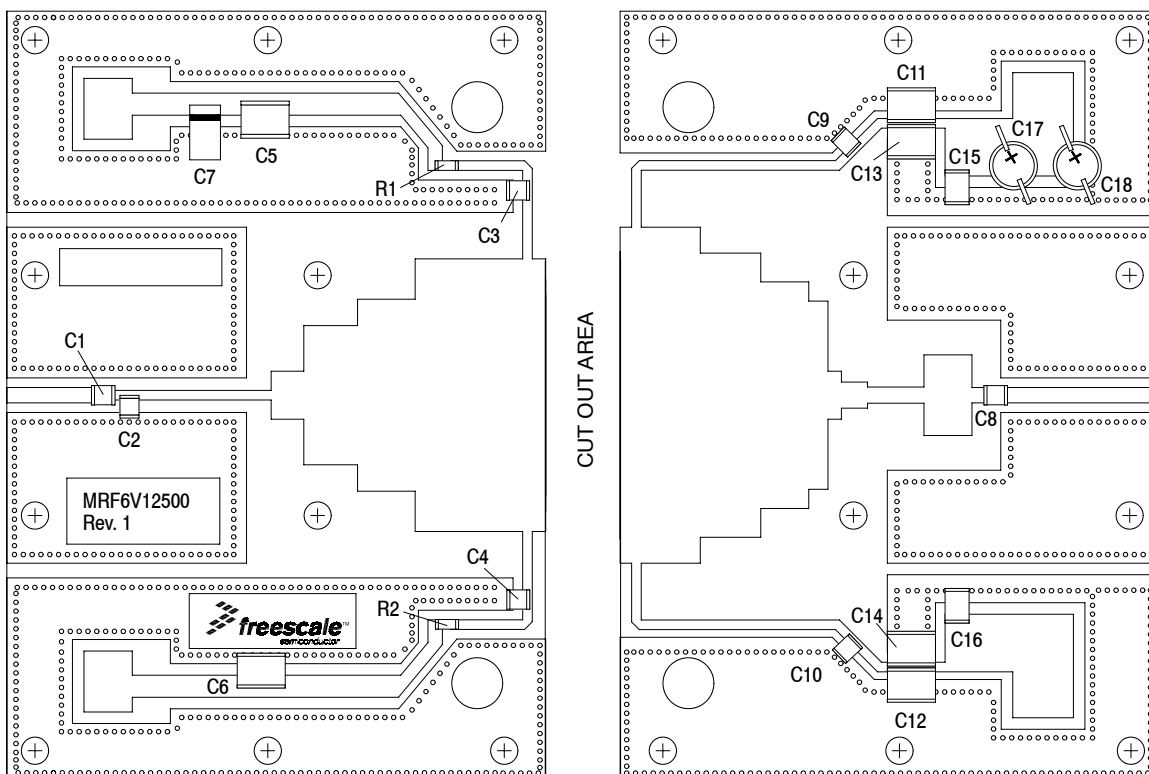

Figure 13. MRF6V12500H(HS) Test Circuit Component Layout — 960-1215 MHz

Table 6. MRF6V12500H(HS) Test Circuit Component Designations and Values — 960-1215 MHz

| Part | Description | Part Number | Manufacturer |
|------------------|---|----------------------|--------------|
| C1 | 2.2 pF Chip Capacitor | ATC100B2R2JT500XT | ATC |
| C2 | 0.2 pF Chip Capacitor | ATC100B0R2BT500XT | ATC |
| C3, C4 | 33 pF Chip Capacitors | ATC100B330JT500XT | ATC |
| C5, C6, C11, C12 | 2.2 μ F, 100 V Chip Capacitors | G2225X7R225KT3AB | ATC |
| C7 | 22 μ F, 35 V Tantalum Capacitor | T491X226K035AT | Kemet |
| C8 | 8.2 pF Chip Capacitor | ATC100B8R2CT500XT | ATC |
| C9, C10 | 39 pF Chip Capacitors | ATC100B390JT500XT | ATC |
| C13, C14 | 0.022 μ F, 100 V Chip Capacitors | C1825C223K1GAC | Kemet |
| C15, C16 | 0.10 μ F, 100 V Chip Capacitors | C1812F104K1RAC | Kemet |
| C17, C18 | 470 μ F, 63 V Electrolytic Capacitors | MCGPR63V477M13X26-RH | Multicomp |
| R1, R2 | 22 Ω , 1/4 W Chip Resistors | CRCW120622R0FKEA | Vishay |
| PCB | 0.030", $\epsilon_r = 2.55$ | AD255A | Arlon |

TYPICAL CHARACTERISTICS — 960-1215 MHz

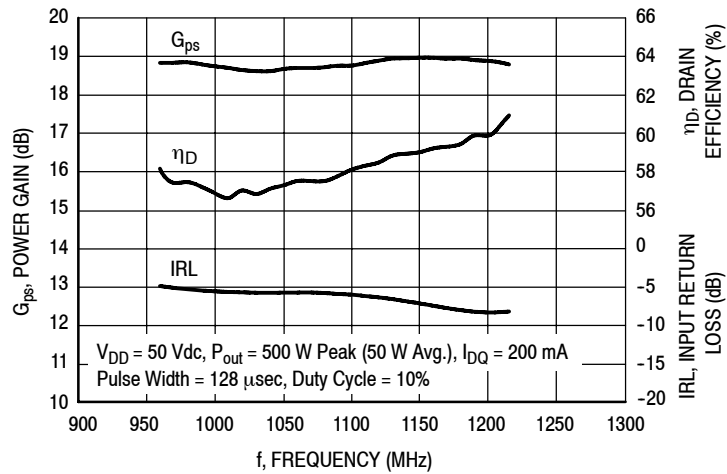

Figure 14. Pulsed Power Gain, Drain Efficiency and IRL versus Frequency

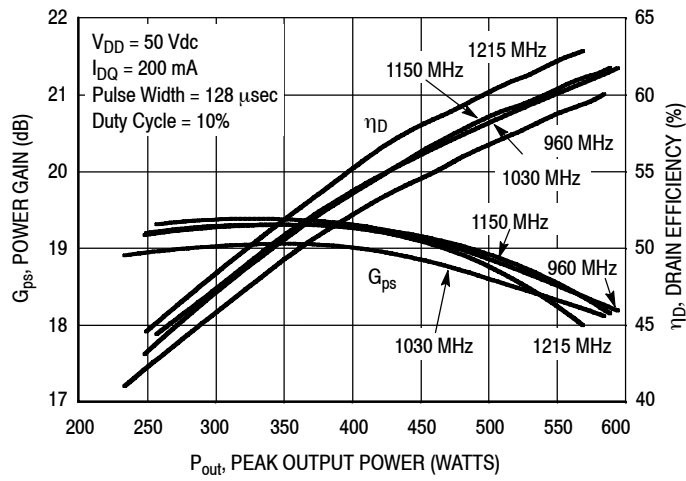
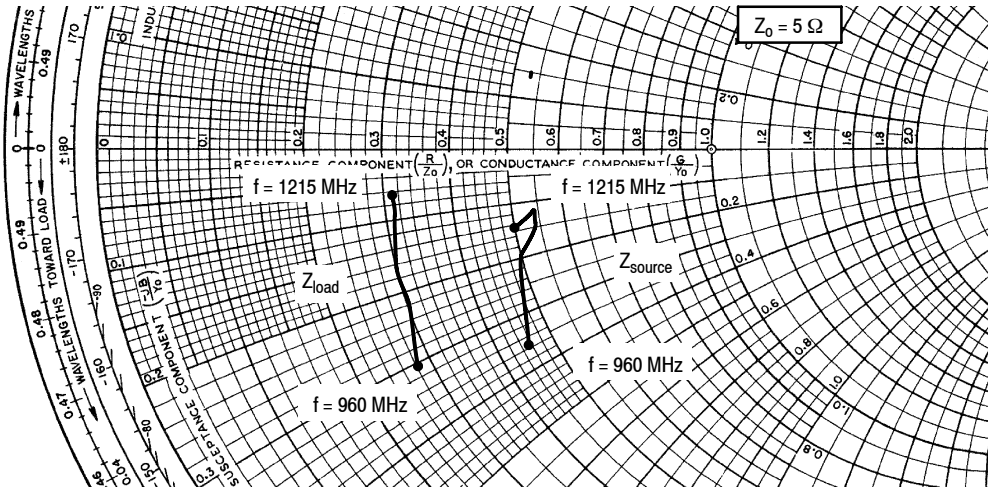

Figure 15. Power Gain and Drain Efficiency versus Output Power



$V_{DD} = 50 \text{ Vdc}$, $I_{DQ} = 200 \text{ mA}$, $P_{out} = 500 \text{ W Peak}$

| f MHz | Z_{source} Ω | Z_{load} Ω |
|----------|--------------------------|------------------------|
| 960 | $2.25 - j1.78$ | $1.38 - j1.53$ |
| 1030 | $2.51 - j1.02$ | $1.48 - j1.11$ |
| 1090 | $2.69 - j0.73$ | $1.51 - j0.78$ |
| 1150 | $2.71 - j0.65$ | $1.53 - j0.49$ |
| 1215 | $2.48 - j0.76$ | $1.53 - j0.33$ |

Z_{source} = Test circuit impedance as measured from gate to ground.

Z_{load} = Test circuit impedance as measured from drain to ground.

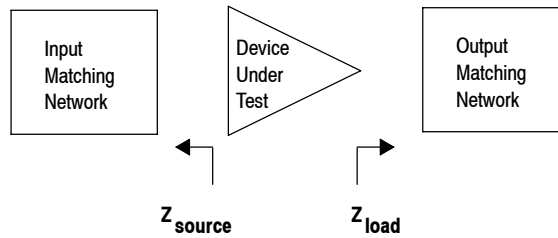
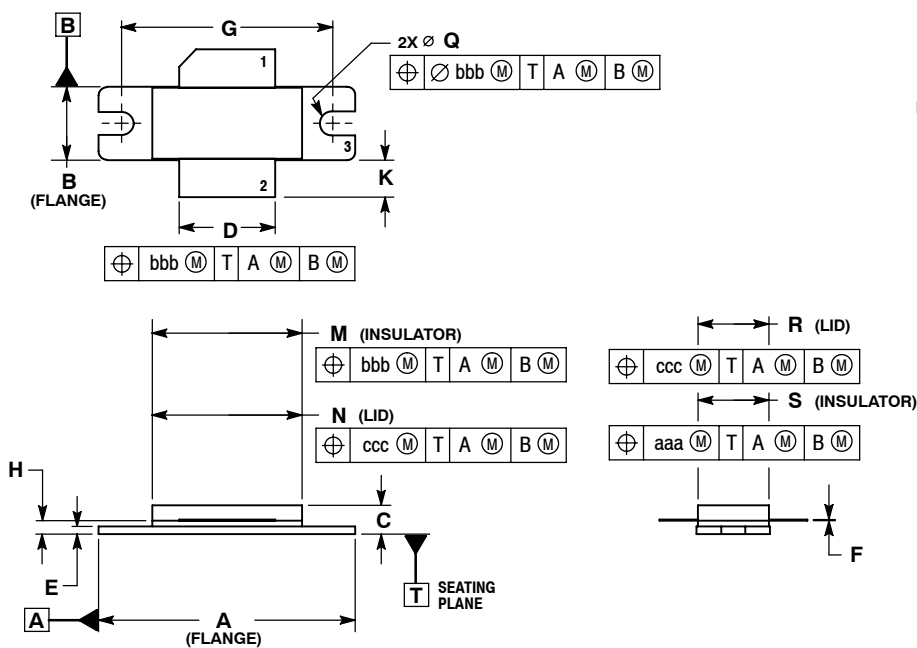

Figure 16. Series Equivalent Source and Load Impedance — 960-1215 MHz

PACKAGE DIMENSIONS



- NOTES:
1. DIMENSIONING AND TOLERANCING PER ANSI Y14.5M-1994.
 2. CONTROLLING DIMENSION: INCH.
 3. DELETED
 4. DIMENSION H IS MEASURED 0.030 (0.762) AWAY FROM PACKAGE BODY.

| DIM | INCHES | | MILLIMETERS | |
|-----|-----------|-------|-------------|--------|
| | MIN | MAX | MIN | MAX |
| A | 1.335 | 1.345 | 33.91 | 34.16 |
| B | 0.380 | 0.390 | 9.65 | 9.91 |
| C | 0.125 | 0.170 | 3.18 | 4.32 |
| D | 0.495 | 0.505 | 12.57 | 12.83 |
| E | 0.035 | 0.045 | 0.89 | 1.14 |
| F | 0.003 | 0.006 | 0.08 | 0.15 |
| G | 1.100 BSC | | 27.94 BSC | |
| H | 0.057 | 0.067 | 1.45 | 1.70 |
| K | 0.170 | 0.210 | 4.32 | 5.33 |
| M | 0.774 | 0.786 | 19.66 | 19.96 |
| N | 0.772 | 0.788 | 19.60 | 20.00 |
| Q | Ø 118 | Ø 138 | Ø 3.00 | Ø 3.51 |
| R | 0.365 | 0.375 | 9.27 | 9.53 |
| S | 0.365 | 0.375 | 9.27 | 9.52 |
| aaa | 0.005 REF | | 0.127 REF | |
| bbb | 0.010 REF | | 0.254 REF | |
| ccc | 0.015 REF | | 0.381 REF | |

- STYLE 1:
 PIN 1. DRAIN
 2. GATE
 3. SOURCE

**CASE 465-06
 ISSUE G
 NI-780
 MRF6V12500HR3**

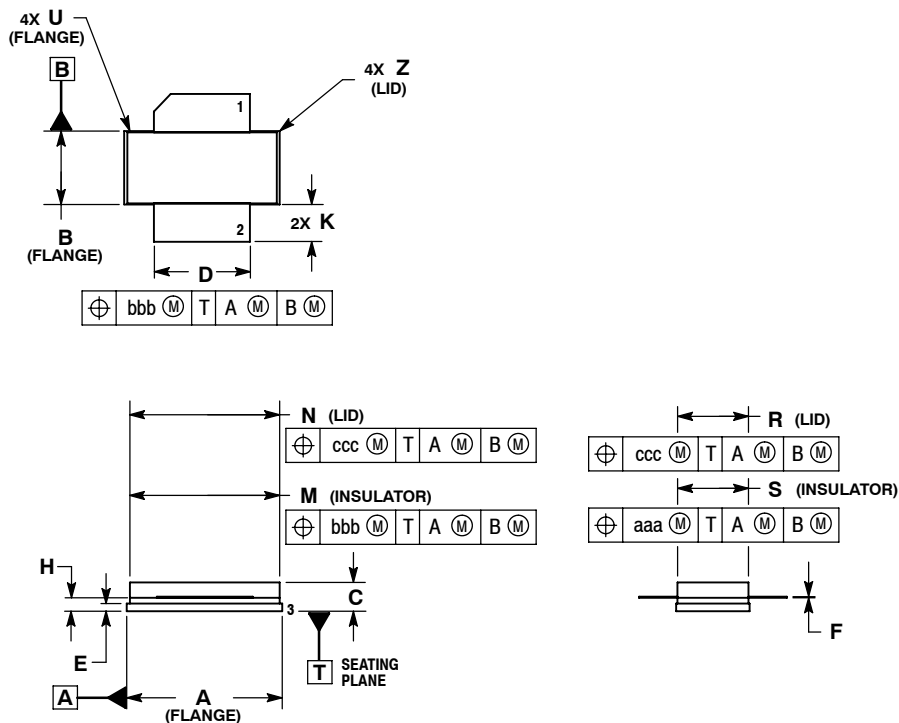

- NOTES:
1. DIMENSIONING AND TOLERANCING PER ANSI Y14.5M-1994.
 2. CONTROLLING DIMENSION: INCH.
 3. DELETED
 4. DIMENSION H IS MEASURED 0.030 (0.762) AWAY FROM PACKAGE BODY.

| DIM | INCHES | | MILLIMETERS | |
|-----|-----------|-------|-------------|-------|
| | MIN | MAX | MIN | MAX |
| A | 0.805 | 0.815 | 20.45 | 20.70 |
| B | 0.380 | 0.390 | 9.65 | 9.91 |
| C | 0.125 | 0.170 | 3.18 | 4.32 |
| D | 0.495 | 0.505 | 12.57 | 12.83 |
| E | 0.035 | 0.045 | 0.89 | 1.14 |
| F | 0.003 | 0.006 | 0.08 | 0.15 |
| H | 0.057 | 0.067 | 1.45 | 1.70 |
| K | 0.170 | 0.210 | 4.32 | 5.33 |
| M | 0.774 | 0.786 | 19.61 | 20.02 |
| N | 0.772 | 0.788 | 19.61 | 20.02 |
| R | 0.365 | 0.375 | 9.27 | 9.53 |
| S | 0.365 | 0.375 | 9.27 | 9.52 |
| U | --- | 0.040 | --- | 1.02 |
| Z | --- | 0.030 | --- | 0.76 |
| aaa | 0.005 REF | | 0.127 REF | |
| bbb | 0.010 REF | | 0.254 REF | |
| ccc | 0.015 REF | | 0.381 REF | |

- STYLE 1:
 PIN 1. DRAIN
 2. GATE
 5. SOURCE

**CASE 465A-06
 ISSUE H
 NI-780S
 MRF6V12500HSR3**

MRF6V12500HR3 MRF6V12500HSR3

PRODUCT DOCUMENTATION AND SOFTWARE

Refer to the following documents, tools and software to aid your design process.

Application Notes

- AN1955: Thermal Measurement Methodology of RF Power Amplifiers

Engineering Bulletins

- EB212: Using Data Sheet Impedances for RF LDMOS Devices

Software

- Electromigration MTTF Calculator
- RF High Power Model

For Software, do a Part Number search at <http://www.freescale.com>, and select the "Part Number" link. Go to the Software & Tools tab on the part's Product Summary page to download the respective tool.

REVISION HISTORY

The following table summarizes revisions to this document.

| Revision | Date | Description |
|----------|------------|--|
| 0 | Sept. 2009 | <ul style="list-style-type: none">• Initial Release of Data Sheet |
| 1 | Apr. 2010 | <ul style="list-style-type: none">• Operating Junction Temperature increased from 200°C to 225°C in Maximum Ratings table and related "Continuous use at maximum temperature will affect MTTF" footnote added, p. 1• Added RF High Power Model availability to Product Software, p. 9 |
| 2 | Sept. 2010 | <ul style="list-style-type: none">• Maximum Ratings table: corrected V_{DSS} from -0.5, +100 to -0.5, +110 Vdc, p. 2• Added 960-1215 MHz Broadband application as follows:<ul style="list-style-type: none">- Typical Performance, p. 1, 2- Fig. 13, Test Circuit Component Layout and Table 6, Test Circuit Component Designations and Values, p. 8- Fig. 14, Pulsed Power Gain, Drain Efficiency and IRL versus Frequency, p. 9- Fig. 15, Power Gain and Drain Efficiency versus Output Power, p. 9- Fig. 16, Series Equivalent Source and Load Impedance, p. 10 |

How to Reach Us:

Home Page:

www.freescale.com

Web Support:

<http://www.freescale.com/support>

USA/Europe or Locations Not Listed:

Freescale Semiconductor, Inc.
Technical Information Center, EL516
2100 East Elliot Road
Tempe, Arizona 85284
1-800-521-6274 or +1-480-768-2130
www.freescale.com/support

Europe, Middle East, and Africa:

Freescale Halbleiter Deutschland GmbH
Technical Information Center
Schatzbogen 7
81829 Muenchen, Germany
+44 1296 380 456 (English)
+46 8 52200080 (English)
+49 89 92103 559 (German)
+33 1 69 35 48 48 (French)
www.freescale.com/support

Japan:

Freescale Semiconductor Japan Ltd.
Headquarters
ARCO Tower 15F
1-8-1, Shimo-Meguro, Meguro-ku,
Tokyo 153-0064
Japan
0120 191014 or +81 3 5437 9125
support.japan@freescale.com

Asia/Pacific:

Freescale Semiconductor China Ltd.
Exchange Building 23F
No. 118 Jianguo Road
Chaoyang District
Beijing 100022
China
+86 10 5879 8000
support.asia@freescale.com

For Literature Requests Only:

Freescale Semiconductor Literature Distribution Center
1-800-441-2447 or +1-303-675-2140
Fax: +1-303-675-2150
LDCForFreescaleSemiconductor@hibbertgroup.com

Information in this document is provided solely to enable system and software implementers to use Freescale Semiconductor products. There are no express or implied copyright licenses granted hereunder to design or fabricate any integrated circuits or integrated circuits based on the information in this document.

Freescale Semiconductor reserves the right to make changes without further notice to any products herein. Freescale Semiconductor makes no warranty, representation or guarantee regarding the suitability of its products for any particular purpose, nor does Freescale Semiconductor assume any liability arising out of the application or use of any product or circuit, and specifically disclaims any and all liability, including without limitation consequential or incidental damages. "Typical" parameters that may be provided in Freescale Semiconductor data sheets and/or specifications can and do vary in different applications and actual performance may vary over time. All operating parameters, including "Typicals", must be validated for each customer application by customer's technical experts. Freescale Semiconductor does not convey any license under its patent rights nor the rights of others. Freescale Semiconductor products are not designed, intended, or authorized for use as components in systems intended for surgical implant into the body, or other applications intended to support or sustain life, or for any other application in which the failure of the Freescale Semiconductor product could create a situation where personal injury or death may occur. Should Buyer purchase or use Freescale Semiconductor products for any such unintended or unauthorized application, Buyer shall indemnify and hold Freescale Semiconductor and its officers, employees, subsidiaries, affiliates, and distributors harmless against all claims, costs, damages, and expenses, and reasonable attorney fees arising out of, directly or indirectly, any claim of personal injury or death associated with such unintended or unauthorized use, even if such claim alleges that Freescale Semiconductor was negligent regarding the design or manufacture of the part.

Freescale™ and the Freescale logo are trademarks of Freescale Semiconductor, Inc. All other product or service names are the property of their respective owners.

© Freescale Semiconductor, Inc. 2009-2010. All rights reserved.

