



PD54008-E PD54008S-E

RF POWER transistor, LdmoST plastic family N-channel enhancement-mode, lateral MOSFETs

Features

- Excellent thermal stability
- Common source configuration
- $P_{OUT} = 8\text{ W}$ with 11.5dB gain @ 500 MHz/7.5 V
- New RF plastic package

Description

The device is a common source N-channel, enhancement-mode lateral field-effect RF power transistor. It is designed for high gain, broad band commercial and industrial applications. It operates at 7 V in common source mode at frequencies of up to 1 GHz. The device boasts the excellent gain, linearity and reliability of ST's latest LDMOS technology mounted in the first true SMD plastic RF power package, PowerSO-10RF. Device's superior linearity performance makes it an ideal solution for portable radio.

The PowerSO-10 plastic package, designed to offer high reliability, is the first ST JEDEC approved, high power SMD package. It has been specially optimized for RF needs and offers excellent RF performances and ease of assembly.

Mounting recommendations are available in www.st.com/rf/ (look for application note AN1294).

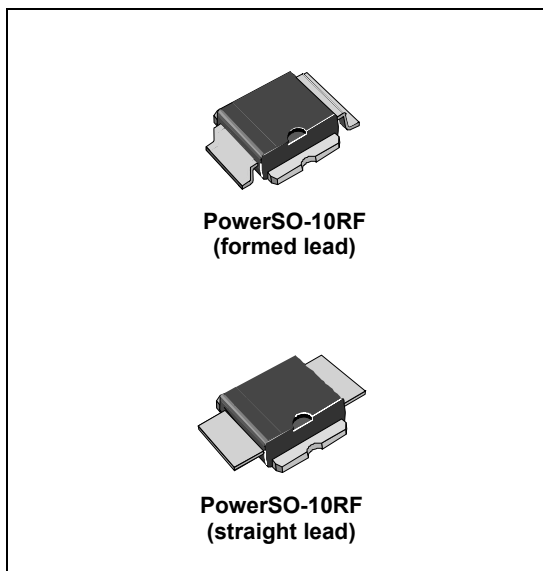

Figure 1. Pin connection

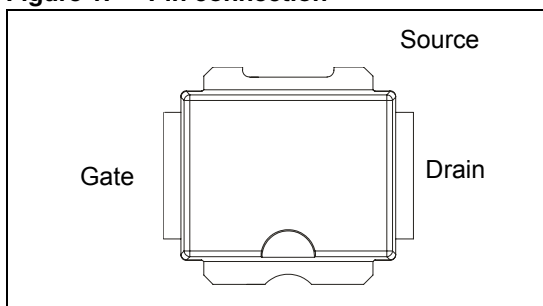

Table 1. Device summary

Order code	Package	Packing
PD54008-E-E	PowerSO-10RF (formed lead)	Tube
PD54008S-E-E	PowerSO-10RF (straight lead)	Tube
PD54008TR-E	PowerSO-10RF (formed lead)	Tape and reel
PD54008STR-E	PowerSO-10RF (straight lead)	Tape and reel

Contents

1	Electrical data	3
1.1	Maximum ratings	3
1.2	Thermal data	3
2	Electrical characteristics	4
2.1	Static	4
2.2	Dynamic	4
2.3	Moisture sensitivity level	4
3	Impedance	5
4	Typical performance	6
4.1	PD54008-E	7
4.2	PD54008S-E	10
5	Test circuit	13
6	Circuit layout	15
7	Common source s-parameter	16
8	Package mechanical data	22
9	Revision history	28

1 Electrical data

1.1 Maximum ratings

Table 2. Absolute maximum ratings ($T_{CASE} = 25^{\circ}C$)

Symbol	Parameter	Value	Unit
$V_{(BR)DSS}$	Drain-source voltage	25	V
V_{GS}	Gate-source voltage	± 20	V
I_D	Drain current	5	A
P_{DISS}	Power dissipation (@ $T_C = 70^{\circ}C$)	73	W
T_J	Max. operating junction temperature	165	$^{\circ}C$
T_{STG}	Storage temperature	-65 to +150	$^{\circ}C$

1.2 Thermal data

Table 3. Thermal data

Symbol	Parameter	Value	Unit
R_{thJC}	Junction - case thermal resistance	1.2	$^{\circ}C/W$

2 Electrical characteristics

$T_{CASE} = +25\text{ }^{\circ}\text{C}$

2.1 Static

Table 4. Static

Symbol	Test conditions		Min.	Typ.	Max.	Unit
I_{DSS}	$V_{GS} = 0$	$V_{DS} = 25\text{ V}$			1	μA
I_{GSS}	$V_{GS} = 20\text{ V}$	$V_{DS} = 0$			1	μA
$V_{GS(Q)}$	$V_{DS} = 10\text{ V}$	$I_D = 150\text{ mA}$	2.0		5.0	V
$V_{DS(ON)}$	$V_{GS} = 10\text{ V}$	$I_D = 2\text{ A}$			0.6	V
g_{FS}	$V_{DS} = 10\text{ V}$	$I_D = 2\text{ A}$	2.0	2.5		mho
C_{ISS}	$V_{GS} = 0$	$V_{DS} = 7.5\text{ V}$		91		pF
C_{OSS}	$V_{GS} = 0$	$V_{DS} = 7.5\text{ V}$		68		pF
C_{RSS}	$V_{GS} = 0$	$V_{DS} = 7.5\text{ V}$		8.5		pF

2.2 Dynamic

Table 5. Dynamic

Symbol	Test conditions		Min.	Typ.	Max.	Unit
P_{1dB}	$V_{DD} = 7.5\text{ V}$, $I_{DQ} = 150\text{ mA}$	$f = 500\text{ MHz}$	8			W
G_P	$V_{DD} = 7.5\text{ V}$, $I_{DQ} = 150\text{ mA}$, $P_{OUT} = 8\text{ W}$	$f = 500\text{ MHz}$	10	11.5		dB
h_D	$V_{DD} = 7.5\text{ V}$, $I_{DQ} = 150\text{ mA}$, $P_{OUT} = 8\text{ W}$	$f = 500\text{ MHz}$	50	55		%
Load mismatch	$V_{DD} = 9.5\text{ V}$, $I_{DQ} = 150\text{ mA}$, $P_{OUT} = 8\text{ W}$, $f = 500\text{ MHz}$ All phase angles		20:1			VSWR

2.3 Moisture sensitivity level

Table 6. Moisture sensitivity level

Test methodology	Rating
J-STD-020B	MSL 3

3 Impedance

Figure 2. Current conventions

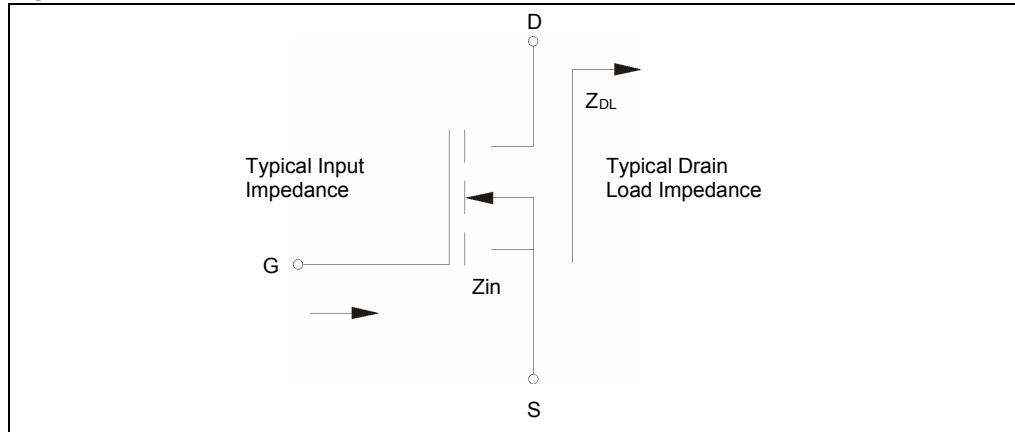

Table 7. Impedance data

PD54008-E			PD54008S-E		
Freq. (MHz)	Z _{IN} (Ω)	Z _{DL} (Ω)	Freq. (MHz)	Z _{IN} (Ω)	Z _{DL} (Ω)
175	2.3 - j 4.8	1.9 + j 1.9	480	1.22 - j 0.91	1.04 - j 0.65
200	2.1 - j 4.0	2.8 + j 1.1	500	1.20 - j 0.48	1.28 - j 0.55
250	1.3 - j 3.8	2.3 + j 0.0	520	1.28 - j 0.74	1.44 - j 0.99
480	1.65 + j 0.53	1.35 - j 1.57			
500	1.73 + j 0.96	1.48 - j 1.62			
520	1.73 + j 1.15	1.47 - j 1.97			

4 Typical performance

Figure 3. Capacitance vs. drain voltage

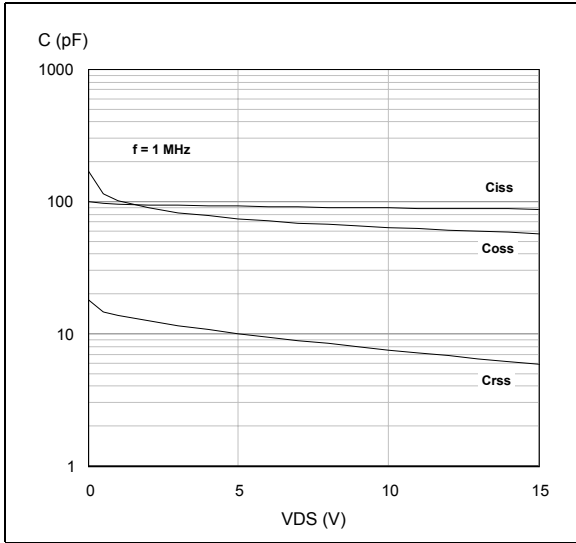

Figure 4. Drain current vs. gate-source voltage

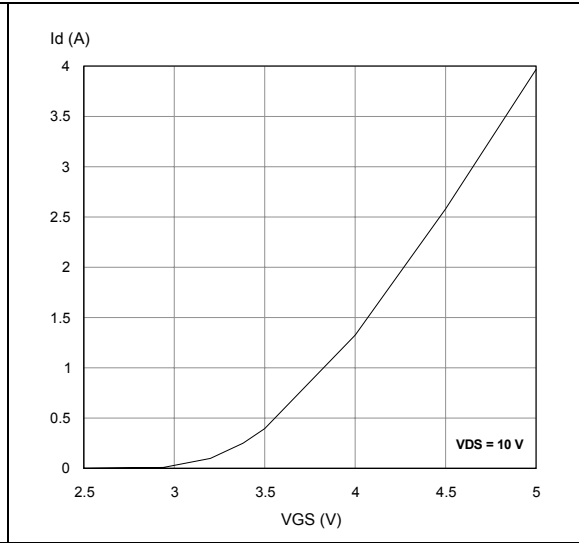
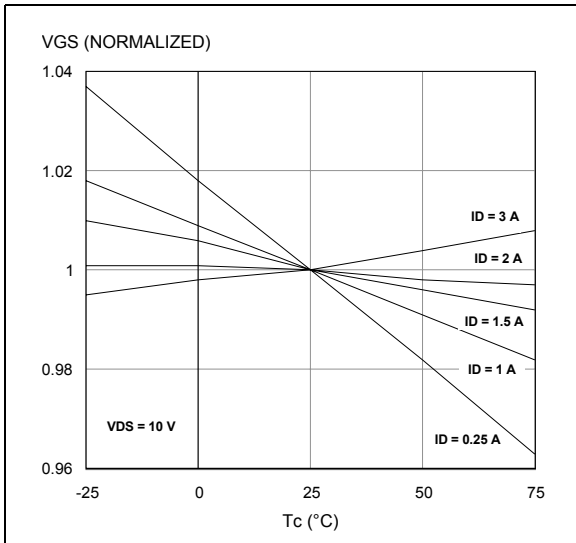

Figure 5. Gate-source voltage vs. case temperature



4.1 PD54008-E

Figure 6. Output power vs. input power

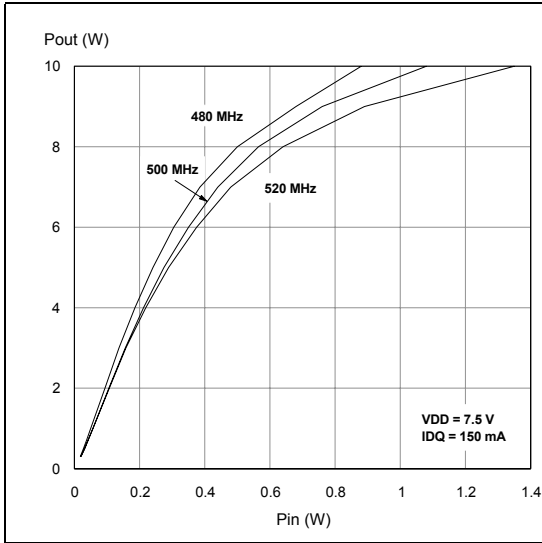

Figure 7. Power gain vs. output power

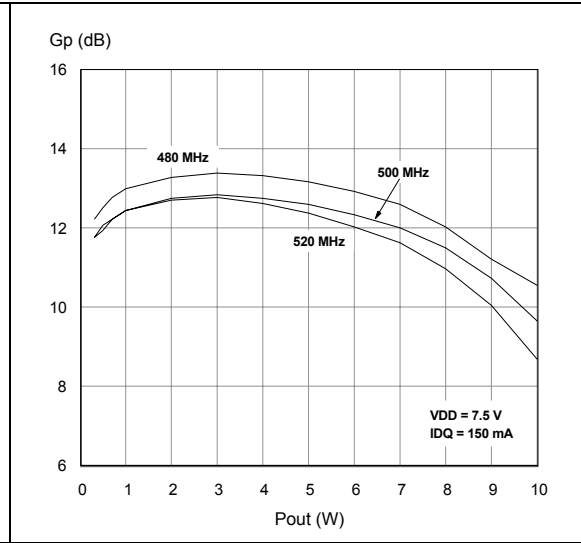

Figure 8. Drain efficiency vs. output power

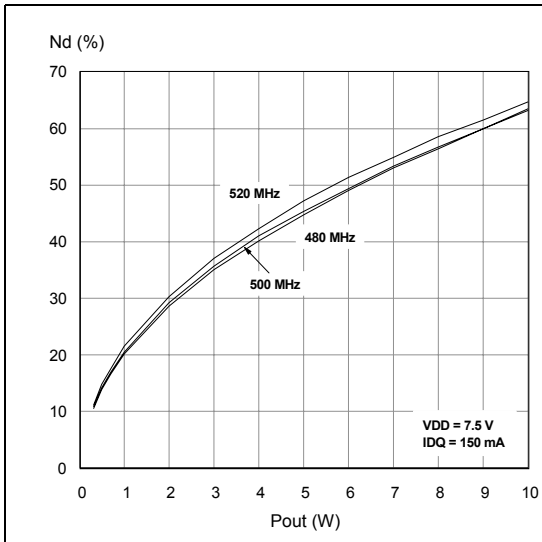

Figure 9. Return loss vs. output power

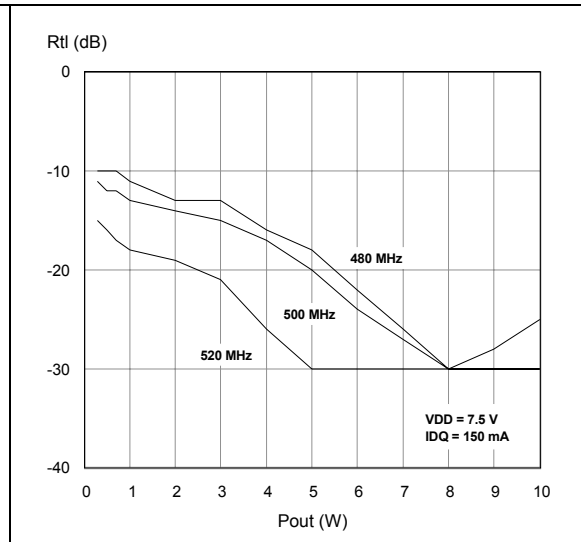

Figure 10. Output power vs. bias current

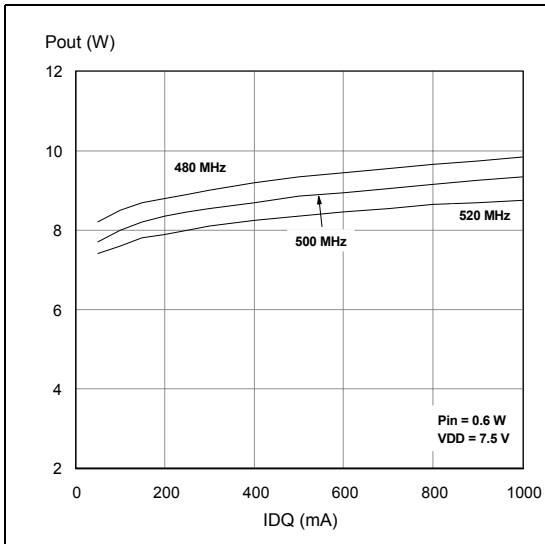

Figure 11. Drain efficiency vs. bias current

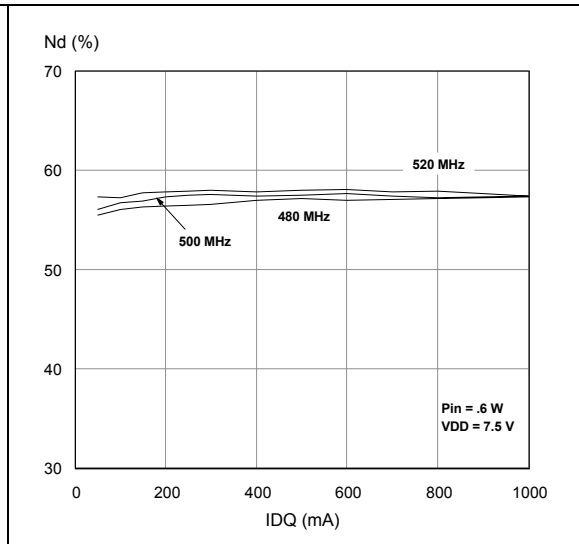

Figure 12. Output power vs. drain voltage

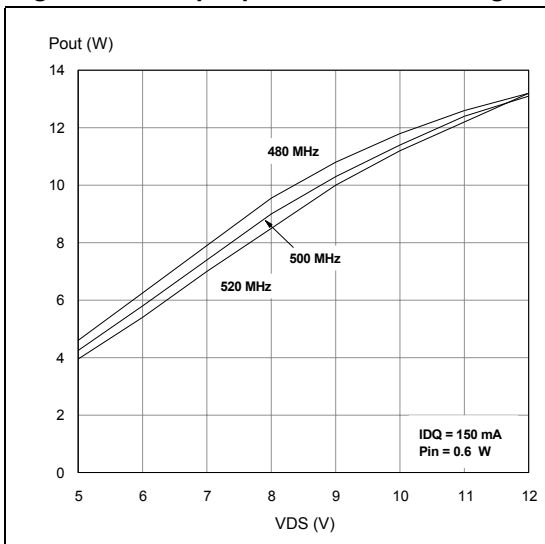

Figure 13. Drain efficiency vs. drain voltage

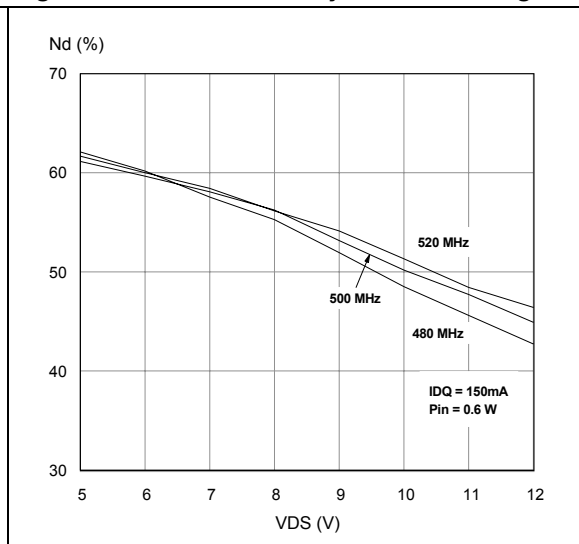

Figure 14. Output power vs. gate bias voltage Table 8. IMD3 vs. output power (470MHz)

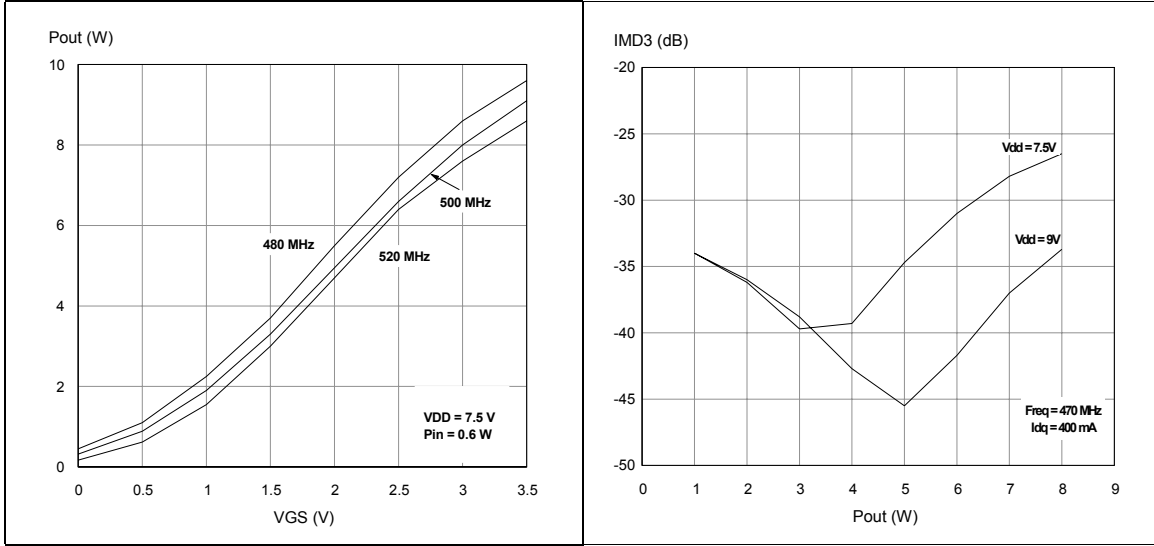

Figure 15. Power gain vs. output power

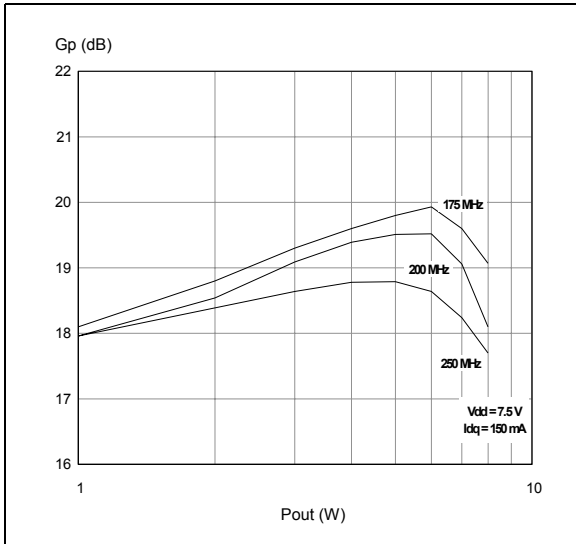
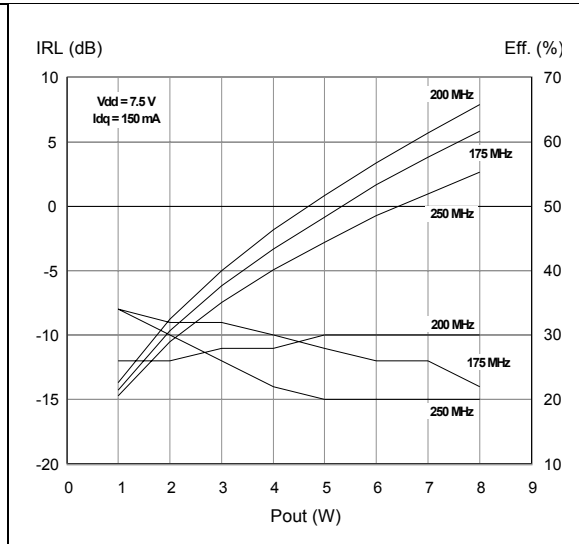

Table 9. Return loss and efficiency vs. output power



4.2 PD54008S-E

Figure 16. Output power vs. input power

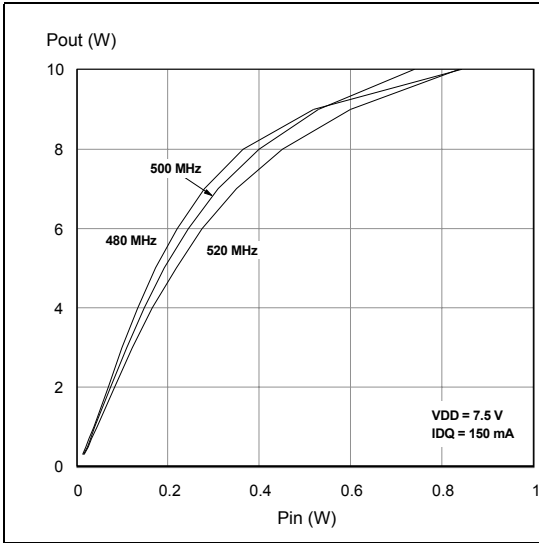

Figure 17. Power gain vs. output power

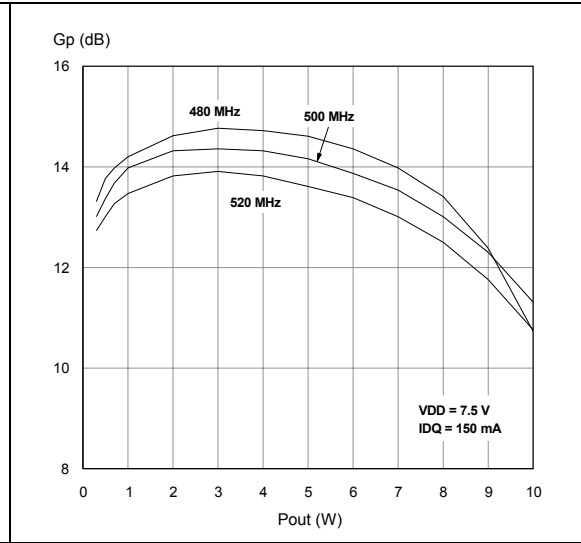

Figure 18. Drain efficiency vs. output power

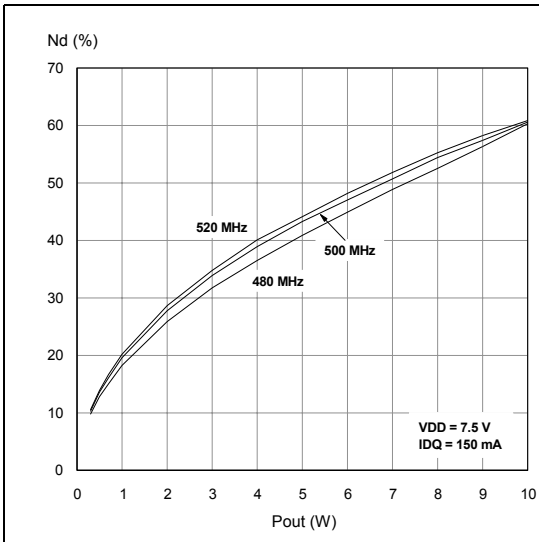

Figure 19. Return loss vs. output power

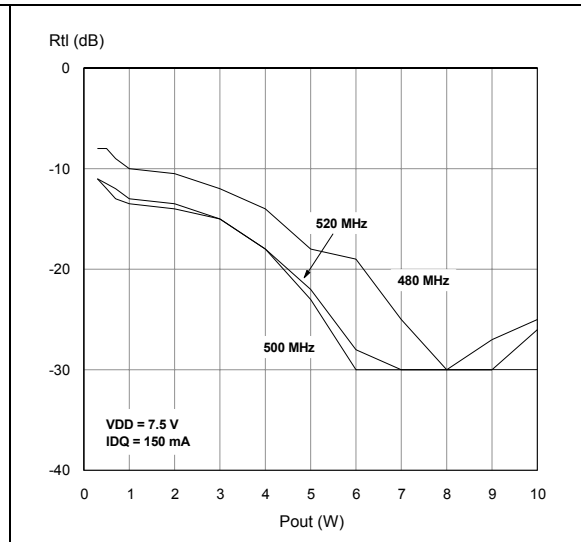

Figure 20. Output power vs. bias current

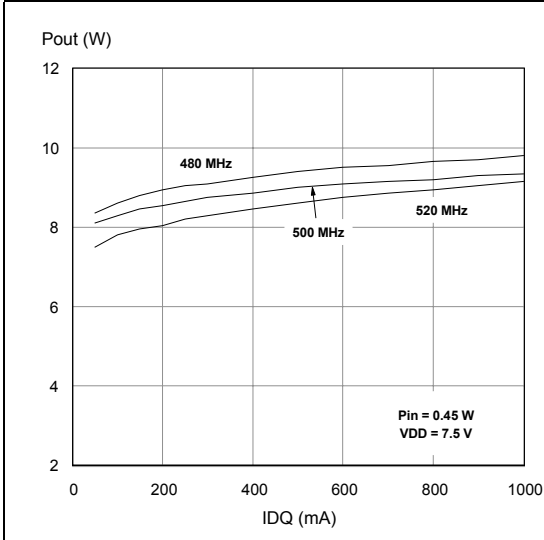

Figure 21. Drain efficiency vs. bias current

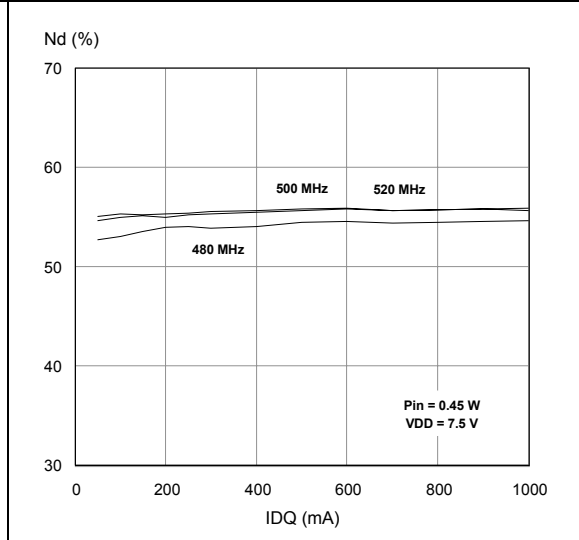

Figure 22. Output power vs. drain voltage

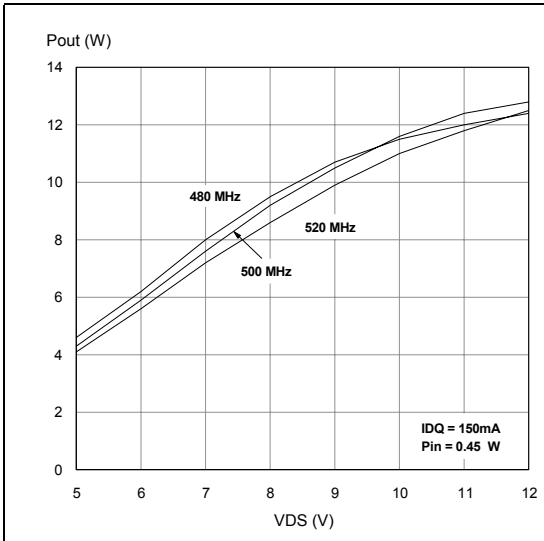

Figure 23. Drain efficiency vs. drain voltage

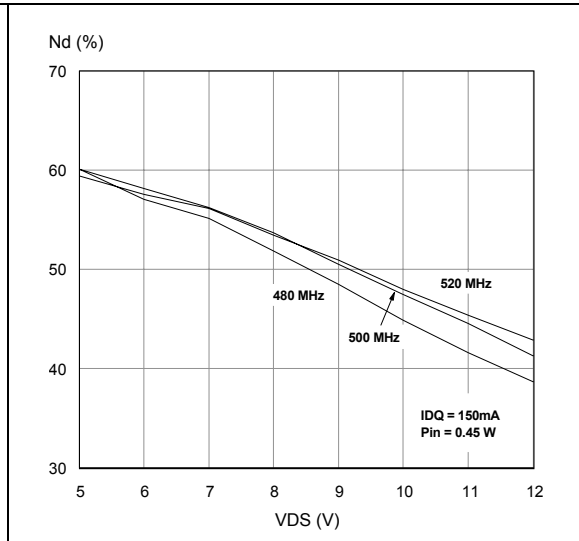
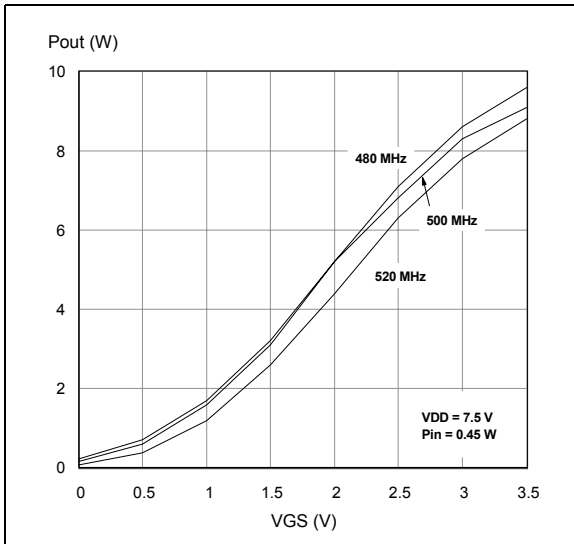

Figure 24. Output power vs. gate bias voltage



5 Test circuit

Figure 25. Test circuit schematic

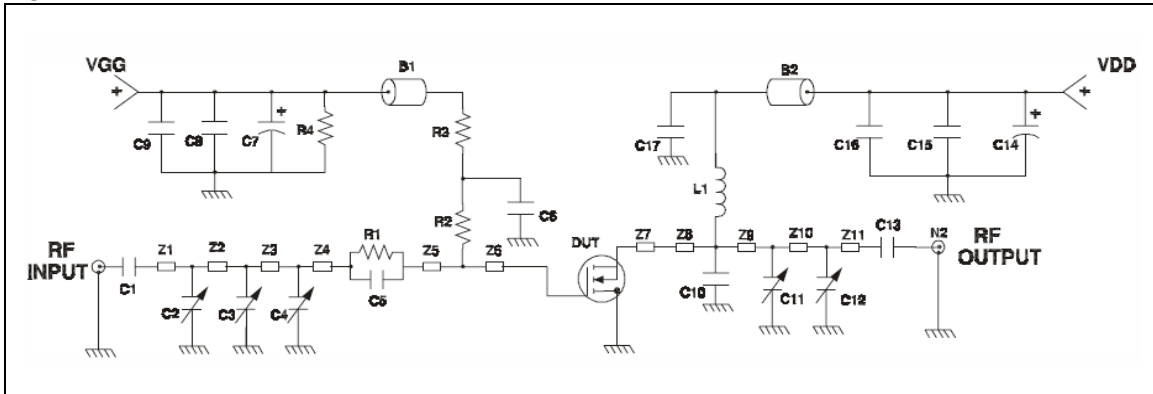

Table 10. Test circuit component part list

Component	Description
B1,B2	Short ferrite bead, fair rite products (2743021446)
C1,C13	240 pF, 100 mil chip capacitor
C2,C3,C4,C10,C11,C12	0 to 20 pF trimmer capacitor
C5	130 pF, 100 mil chip capacitor
C6,C17	120 pF, 100 mil chip capacitor
C7,C14	10 μ F, 50 V electrolytic capacitor
C8,C15	1.200 pF, 100 mil chip capacitor
C9,C16	0.1 F, 100 mil chip capacitor
L1	55,5 Nh, 5 turn, Coilcraft
N1,N2	Type N flange mount
R1	15 Ω , 0805 chip resistor
R2	1.0 k Ω , 1/8 W resistor
R3	15 Ω , 0805 chip resistor
R4	33 k Ω , 1/8 W resistor
Z1	0.175" X 0.080" microstrip
Z2	1.049" X 0.080" microstrip
Z3	0.289" X 0.080" microstrip
Z4	0.026" X 0.080" microstrip
Z5	0.192" X 0.223" microstrip
Z6,Z7	0.260" X 0.223" microstrip
Z8	0.064" X 0.080" microstrip

Table 10. Test circuit component part list (continued)

Component	Description
Z9	0.334" X 0.080" microstrip
Z10	0.985" X 0.080" microstrip
Z11	0.472" X 0.080" microstrip
Board	ROGER, ultra lam 2000 THK 0.030", $\epsilon_r = 2.55$ 2oz. ED cu 2 SIDES.

6 Circuit layout

Figure 26. Test fixture component layout

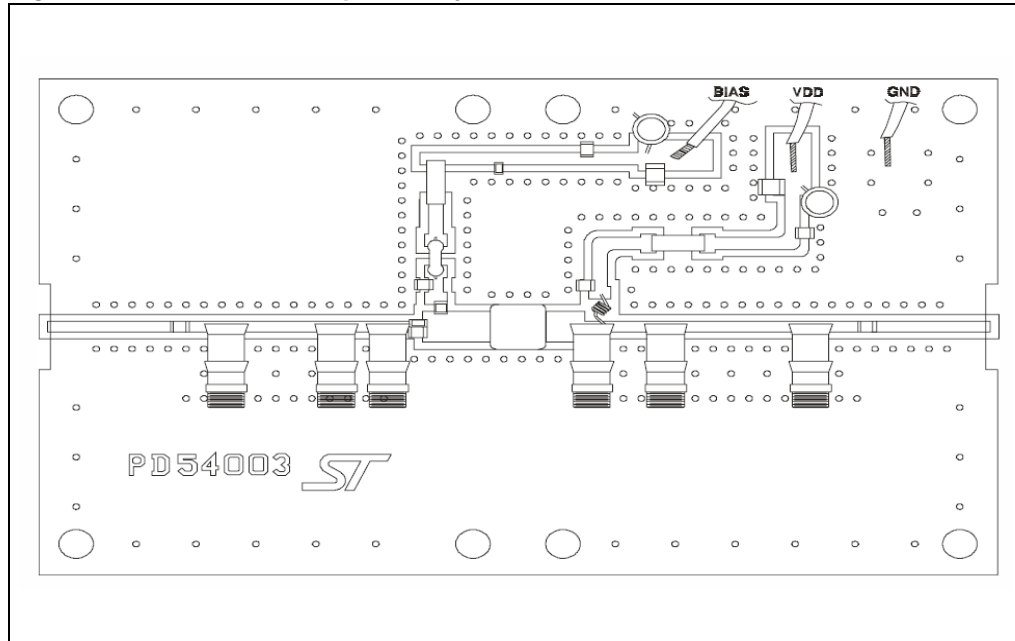
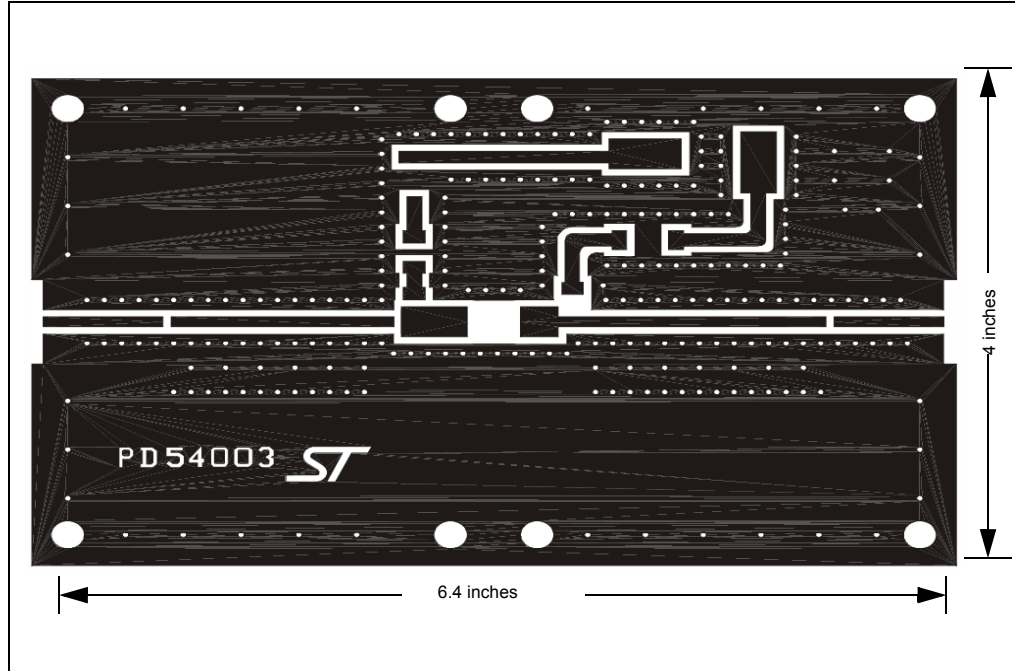

Figure 27. Test circuit photomaster



7 Common source s-parameter

Table 11. S-parameter for PD54008-E ($V_{DS} = 7.5\text{ V}$ $I_{DS} = 150\text{ mA}$)

Freq (MHz)	IS11I	S11.F	IS21I	S21.F	IS12I	S12.F	IS22I	S22.F
50	0.771	-164	7.80	86	0.036	-4	0.773	-164
100	0.819	-170	3.81	75	0.034	-14	0.786	-170
150	0.850	-172	2.47	65	0.033	-21	0.800	-171
200	0.865	-174	1.76	57	0.030	-28	0.826	-172
250	0.881	-175	1.32	50	0.028	-35	0.847	-172
300	0.896	-176	1.03	43	0.025	-39	0.867	-173
350	0.909	-176	0.82	38	0.023	-43	0.886	-174
400	0.921	-177	0.67	33	0.021	-46	0.897	-175
450	0.930	-178	0.56	29	0.018	-51	0.912	-176
500	0.939	-179	0.47	24	0.016	-52	0.924	-177
550	0.944	179	0.40	21	0.014	-53	0.930	-178
600	0.952	179	0.35	18	0.013	-56	0.938	-179
650	0.956	178	0.30	15	0.011	-55	0.943	180
700	0.960	177	0.27	13	0.009	-54	0.949	179
750	0.961	176	0.24	10	0.008	-54	0.952	179
800	0.963	175	0.21	8	0.007	-51	0.955	178
850	0.966	174	0.19	6	0.006	-49	0.960	177
900	0.967	174	0.17	4	0.004	-34	0.964	176
950	0.968	173	0.16	3	0.004	-34	0.964	175
1000	0.969	172	0.14	1	0.003	-28	0.962	175
1050	0.972	171	0.13	0	0.003	-6	0.969	174
1100	0.970	171	0.12	-1	0.002	7	0.967	173
1150	0.969	170	0.11	-2	0.003	25	0.963	173
1200	0.971	169	0.10	-3	0.003	49	0.966	172
1250	0.970	169	0.10	-4	0.005	58	0.969	172
1300	0.970	168	0.09	-5	0.005	61	0.969	171
1350	0.970	167	0.09	-6	0.006	68	0.966	170
1400	0.969	167	0.08	-6	0.006	70	0.965	169
1450	0.967	166	0.07	-7	0.007	79	0.965	169
1500	0.963	166	0.07	-8	0.008	92	0.964	168

Table 12. S-parameter PD54008-E ($V_{DS} = 7.5\text{ V}$ $I_{DS} = 800\text{ mA}$)

Freq (MHz)	IS11I	S11.F	IS21I	S21.F	IS12I	S12.F	IS22I	S22.F
50	0.837	-173	8.92	84	0.017	-2	0.867	-174
100	0.882	-176	4.35	79	0.017	-7	0.870	-177
150	0.902	-178	3.00	75	0.017	-8	0.868	-178
200	0.909	-179	2.17	71	0.016	-12	0.876	-178
250	0.912	-180	1.71	66	0.016	-14	0.878	-179
300	0.918	180	1.40	61	0.015	-16	0.884	-179
350	0.920	179	1.17	57	0.014	-18	0.890	-180
400	0.925	179	1.00	52	0.013	-19	0.893	-180
450	0.928	178	0.86	48	0.013	-21	0.902	180
500	0.932	177	0.75	44	0.012	-22	0.911	179
550	0.935	177	0.66	41	0.011	-20	0.914	179
600	0.939	176	0.59	38	0.01	-22	0.920	178
650	0.944	175	0.53	34	0.009	-17	0.924	178
700	0.947	175	0.47	32	0.008	-13	0.927	177
750	0.946	174	0.43	29	0.008	-12	0.932	177
800	0.951	174	0.39	26	0.007	-9	0.933	176
850	0.953	173	0.36	24	0.007	-4	0.939	175
900	0.954	172	0.33	22	0.006	6	0.942	175
950	0.955	172	0.30	19	0.006	9	0.944	174
1000	0.958	171	0.28	17	0.006	15	0.943	174
1050	0.958	170	0.26	15	0.005	23	0.950	173
1100	0.957	170	0.24	13	0.006	31	0.947	173
1150	0.959	169	0.23	11	0.006	40	0.946	172
1200	0.969	169	0.21	10	0.006	46	0.950	172
1250	0.961	168	0.20	8	0.007	50	0.953	171
1300	0.960	167	0.19	5	0.008	51	0.954	171
1350	0.958	167	0.18	3	0.008	54	0.951	170
1400	0.959	166	0.16	1	0.008	61	0.950	169
1450	0.958	166	0.15	1	0.009	67	0.951	169
1500	0.953	165	0.14	0	0.009	80	0.950	168

Table 13. S-parameter for PD54008-E ($V_{DS} = 7.5\text{ V}$ $I_{DS} = 1.5\text{ A}$)

Freq (MHz)	IS11I	S11.F	IS21I	S21.F	IS12I	S12.F	IS22I	S22.F
50	0.852	-174	8.94	84	0.014	-1	0.885	-175
100	0.896	-176	4.37	80	0.014	-5	0.887	-178
150	0.917	-178	2.96	77	0.014	-6	0.886	-179
200	0.923	-180	2.20	73	0.014	-8	0.891	-179
250	0.924	180	1.75	69	0.013	-8	0.891	-180
300	0.927	179	1.44	65	0.013	-10	0.897	180
350	0.930	178	1.21	60	0.012	-11	0.900	179
400	0.931	178	1.04	57	0.012	-13	0.901	179
450	0.933	177	0.91	53	0.011	-12	0.905	179
500	0.936	177	0.79	49	0.010	-11	0.913	178
550	0.938	176	0.70	45	0.010	-10	0.916	178
600	0.942	175	0.63	42	0.009	-10	0.920	177
650	0.945	175	0.57	39	0.008	-8	0.924	177
700	0.947	174	0.51	37	0.008	-4	0.927	177
750	0.947	174	0.47	34	0.008	-1	0.931	176
800	0.951	173	0.43	31	0.007	4	0.932	175
850	0.951	173	0.39	29	0.007	7	0.938	175
900	0.952	172	0.36	26	0.007	14	0.938	175
950	0.955	171	0.33	24	0.007	19	0.940	174
1000	0.957	171	0.31	22	0.006	24	0.941	174
1050	0.957	170	0.29	20	0.007	29	0.946	173
1100	0.957	169	0.27	18	0.007	30	0.947	172
1150	0.956	169	0.25	16	0.007	38	0.945	172
1200	0.958	168	0.24	14	0.007	45	0.947	172
1250	0.957	168	0.23	11	0.008	50	0.950	171
1300	0.958	167	0.21	9	0.008	50	0.952	170
1350	0.957	167	0.20	7	0.008	53	0.946	170
1400	0.957	166	0.18	5	0.008	60	0.949	169
1450	0.957	166	0.17	4	0.010	66	0.948	169
1500	0.952	165	0.16	3	0.009	76	0.948	168

Table 14. S-parameter for PD54008S-E ($V_{DS} = 7.5\text{ V}$ $I_{DS} = 150\text{ mA}$)

Freq (MHz)	IS11I	S11.F	IS21I	S21.F	IS12I	S12.F	IS22I	S22.F
50	0.760	-161	9.32	84	0.034	-3	0.743	-160
100	0.810	-167	4.44	72	0.003	-16	0.761	-166
150	0.838	-169	2.86	63	0.031	-24	0.783	-167
200	0.862	-171	2.01	56	0.028	-31	0.817	-168
250	0.881	-172	1.50	48	0.026	-38	0.845	-169
300	0.900	-173	1.16	42	0.023	-43	0.866	-170
350	0.916	-174	0.92	37	0.021	-47	0.888	-171
400	0.927	0	0.75	32	0.019	-51	0.906	-172
450	0.938	-175	0.61	28	0.017	-54	0.918	-173
500	0.945	-176	0.52	25	0.015	-56	0.932	-174
550	0.952	-177	0.44	22	0.013	-59	0.940	-175
600	0.957	-178	0.38	19	0.012	-60	0.950	-176
650	0.963	-178	0.33	16	0.011	-61	0.951	-176
700	0.965	-179	0.29	14	0.009	-60	0.958	-177
750	0.968	-180	0.25	12	0.008	-63	0.960	-178
800	0.973	180	0.23	10	0.007	-65	0.962	-178
850	0.973	179	0.20	9	0.006	-65	0.961	-179
900	0.974	179	0.18	7	0.005	-55	0.971	-180
950	0.976	178	0.17	5	0.005	-58	0.970	180
1000	0.979	178	0.15	4	0.003	-58	0.967	179
1050	0.981	177	0.14	3	0.002	-50	0.970	179
1100	0.978	177	0.13	2	0.002	-36	0.974	178
1150	0.979	177	0.12	1	0.001	-16	0.975	179
1200	0.980	176	0.11	0	0.001	36	0.973	179
1250	0.981	176	0.10	-1	0.001	49	0.990	178
1300	0.981	175	0.10	-3	0.002	60	0.994	176
1350	0.981	175	0.09	-3	0.002	92	0.976	176
1400	0.980	175	0.08	-4	0.002	98	0.977	176
1450	0.977	174	0.08	-4	0.004	110	0.975	175
1500	0.977	174	0.07	-4	0.005	118	0.978	175

Table 15. S-parameter for PD54008S-E ($V_{DS} = 7.5\text{ V}$ $I_{DS} = 800\text{ mA}$)

Freq (MHz)	IS11I	S11.F	IS21I	S21.F	IS12I	S12.F	IS22I	S22.F
50	0.825	-171	10.81	84	0.017	-2	0.844	-172
100	0.871	-174	5.27	79	0.017	-8	0.846	-175
150	0.890	-176	3.54	74	0.017	-11	0.849	-176
200	0.901	-177	2.61	70	0.016	-15	0.857	-176
250	0.905	-177	2.04	64	0.016	-18	0.862	-176
300	0.910	-178	1.66	60	0.015	-22	0.871	-177
350	0.916	-178	1.38	55	0.014	-24	0.879	-177
400	0.922	-178	1.17	51	0.013	-27	0.891	-177
450	0.927	-179	1.00	47	0.012	-30	0.899	-177
500	0.935	-179	0.86	43	0.011	-32	0.908	-177
550	0.938	-180	0.75	40	0.010	-32	0.914	-178
600	0.944	-180	0.66	37	0.009	-35	0.925	-178
650	0.949	180	0.59	34	0.008	-33	0.926	-179
700	0.951	179	0.53	31	0.007	-33	0.932	-179
750	0.953	179	0.47	29	0.007	-32	0.937	-180
800	0.958	178	0.43	26	0.006	-28	0.944	-180
850	0.960	178	0.39	24	0.006	-25	0.940	180
900	0.961	178	0.36	22	0.005	-26	0.951	179
950	0.964	177	0.33	20	0.004	-19	0.950	179
1000	0.966	177	0.30	18	0.004	-17	0.947	178
1050	0.968	176	0.28	16	0.004	-7	0.954	178
1100	0.967	176	0.26	15	0.003	7	0.958	178
1150	0.968	176	0.24	13	0.003	14	0.958	178
1200	0.970	176	0.23	12	0.003	37	0.957	178
1250	0.971	175	0.22	10	0.003	45	0.974	177
1300	0.970	175	0.20	8	0.003	48	0.979	176
1350	0.973	174	0.19	7	0.003	59	0.963	176
1400	0.972	174	0.17	5	0.004	75	0.966	175
1450	0.970	174	0.16	4	0.004	88	0.961	175
1500	0.970	174	0.15	3	0.005	102	0.967	174

Table 16. S-parameter for PD54008S-E ($V_{DS} = 7.5\text{ V}$ $I_{DS} = 1.5\text{ A}$)

Freq (MHz)	IS11I	S11.F	IS21I	S21.F	IS12I	S12.F	IS22I	S22.F
50	0.843	-173	10.89	84	0.001	-2	0.864	-174
100	0.888	-175	5.32	80	0.014	-6	0.863	-176
150	0.905	-177	3.60	76	0.014	-8	0.866	-177
200	0.915	-178	2.66	72	0.013	-11	0.870	-177
250	0.916	-178	2.11	68	0.013	-13	0.875	-178
300	0.920	-179	1.73	63	0.013	-16	0.881	-178
350	0.924	-179	1.44	59	0.012	-18	0.889	-178
400	0.927	-179	1.23	55	0.011	-18	0.893	-178
450	0.934	-180	1.00	51	0.010	-23	0.901	-178
500	0.937	-180	0.93	48	0.010	-22	0.907	-178
550	0.939	180	0.82	44	0.009	-23	0.916	-179
600	0.944	180	0.72	42	0.008	-26	0.923	-179
650	0.948	179	0.65	38	0.008	-24	0.921	-179
700	0.949	179	0.58	36	0.007	-23	0.932	-180
750	0.952	178	0.53	33	0.007	-22	0.934	180
800	0.957	178	0.48	31	0.006	-20	0.937	180
850	0.958	178	0.44	29	0.005	-13	0.936	179
900	0.959	177	0.40	27	0.005	-12	0.946	178
950	0.961	177	0.37	25	0.004	-5	0.945	179
1000	0.963	177	0.35	23	0.005	-2	0.946	178
1050	0.965	176	0.32	21	0.004	7	0.947	178
1100	0.964	176	0.30	19	0.003	15	0.954	177
1150	0.967	176	0.28	17	0.004	28	0.952	178
1200	0.967	175	0.27	15	0.004	39	0.953	178
1250	0.969	175	0.25	13	0.004	46	0.970	177
1300	0.970	175	0.23	11	0.004	50	0.973	176
1350	0.971	174	0.22	10	0.004	56	0.957	176
1400	0.970	174	0.20	8	0.004	69	0.961	175
1450	0.968	174	0.19	7	0.005	81	0.958	175
1500	0.970	173	0.17	6	0.006	95	0.962	174

8 Package mechanical data

In order to meet environmental requirements, ST offers these devices in different grades of ECOPACK[®] packages, depending on their level of environmental compliance. ECOPACK[®] specifications, grade definitions and product status are available at: www.st.com. ECOPACK[®] is an ST trademark.

Table 17. PowerSO-10RF formed lead (Gull Wing) mechanical data

Dim.	mm.			Inch		
	Min.	Typ.	Max.	Min.	Typ.	Max.
A1	0	0.05	0.1	0.	0.0019	0.0038
A2	3.4	3.5	3.6	0.134	0.137	0.142
A3	1.2	1.3	1.4	0.046	0.05	0.054
A4	0.15	0.2	0.25	0.005	0.007	0.009
a		0.2			0.007	
b	5.4	5.53	5.65	0.212	0.217	0.221
c	0.23	0.27	0.32	0.008	0.01	0.012
D	9.4	9.5	9.6	0.370	0.374	0.377
D1	7.4	7.5	7.6	0.290	0.295	0.298
E	13.85	14.1	14.35	0.544	0.555	0.565
E1	9.3	9.4	9.5	0.365	0.37	0.375
E2	7.3	7.4	7.5	0.286	0.292	0.294
E3	5.9	6.1	6.3	0.231	0.24	0.247
F		0.5			0.019	
G		1.2			0.047	
L	0.8	1	1.1	0.030	0.039	0.042
R1			0.25			0.01
R2		0.8			0.031	
T	2 deg	5 deg	8 deg	2 deg	5 deg	8 deg
T1		6 deg			6 deg	
T2		10 deg			10 deg	

Note: Resin protrusions not included (max value: 0.15 mm per side)

Figure 28. Package dimensions

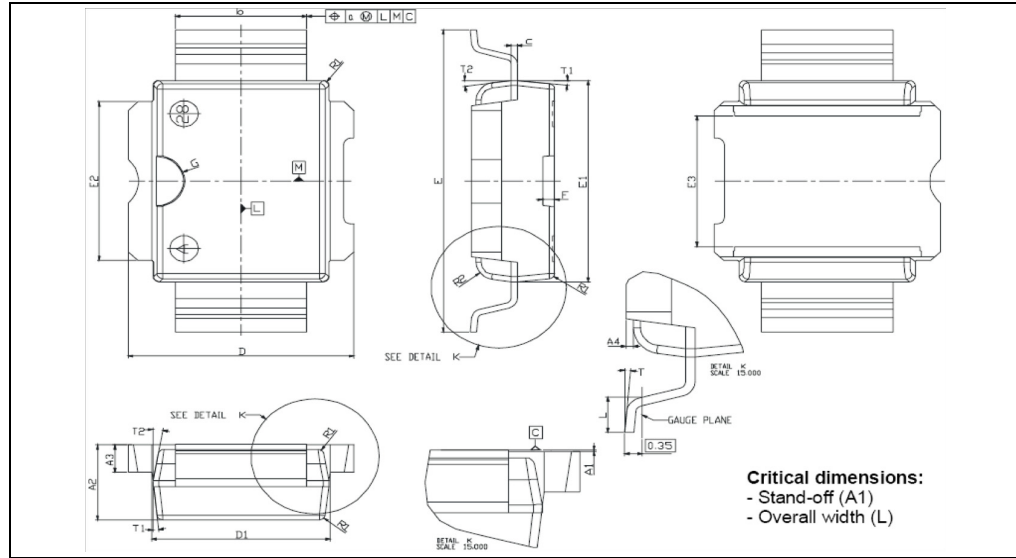

Table 18. PowerSO-10RF straight lead mechanical data

Dim.	mm.			Inch		
	Min.	Typ.	Max.	Min.	Typ.	Max.
A1	1.62	1.67	1.72	0.064	0.065	0.068
A2	3.4	3.5	3.6	0.134	0.137	0.142
A3	1.2	1.3	1.4	0.046	0.05	0.054
A4	0.15	0.2	0.25	0.005	0.007	0.009
a		0.2			0.007	
b	5.4	5.53	5.65	0.212	0.217	0.221
c	0.23	0.27	0.32	0.008	0.01	0.012
D	9.4	9.5	9.6	0.370	0.374	0.377
D1	7.4	7.5	7.6	0.290	0.295	0.298
E	15.15	15.4	15.65	0.595	0.606	0.615
E1	9.3	9.4	9.5	0.365	0.37	0.375
E2	7.3	7.4	7.5	0.286	0.292	0.294
E3	5.9	6.1	6.3	0.231	0.24	0.247
F		0.5			0.019	
G		1.2			0.047	
R1			0.25			0.01
R2		0.8			0.031	
T1		6 deg			6 deg	
T2		10 deg			10 deg	

Note: Resin protrusions not included (max value: 0.15 mm per side)

Figure 29. Package dimensions

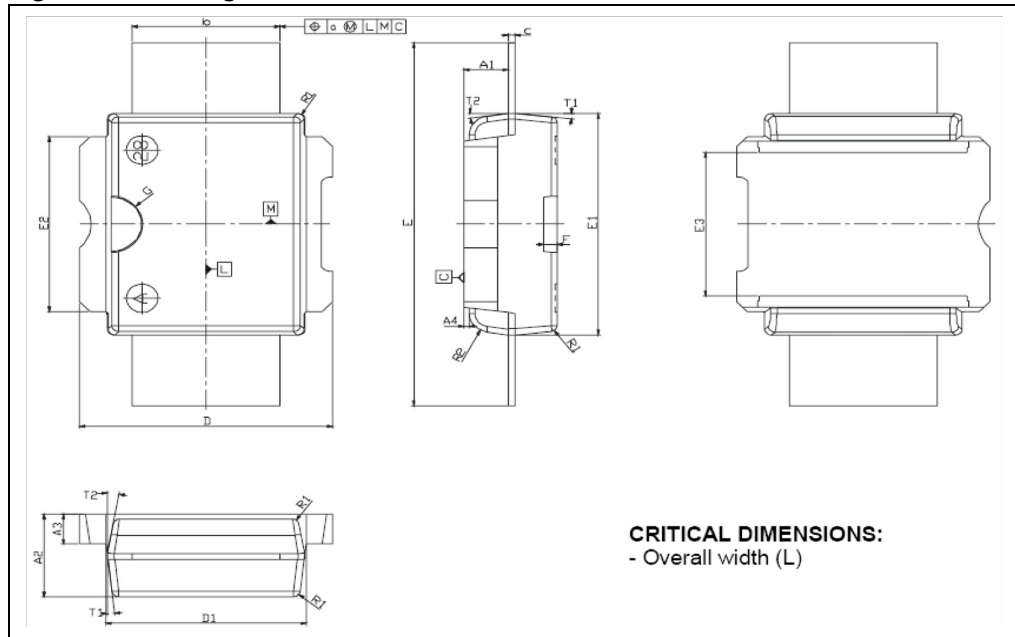

Figure 30. Tube information

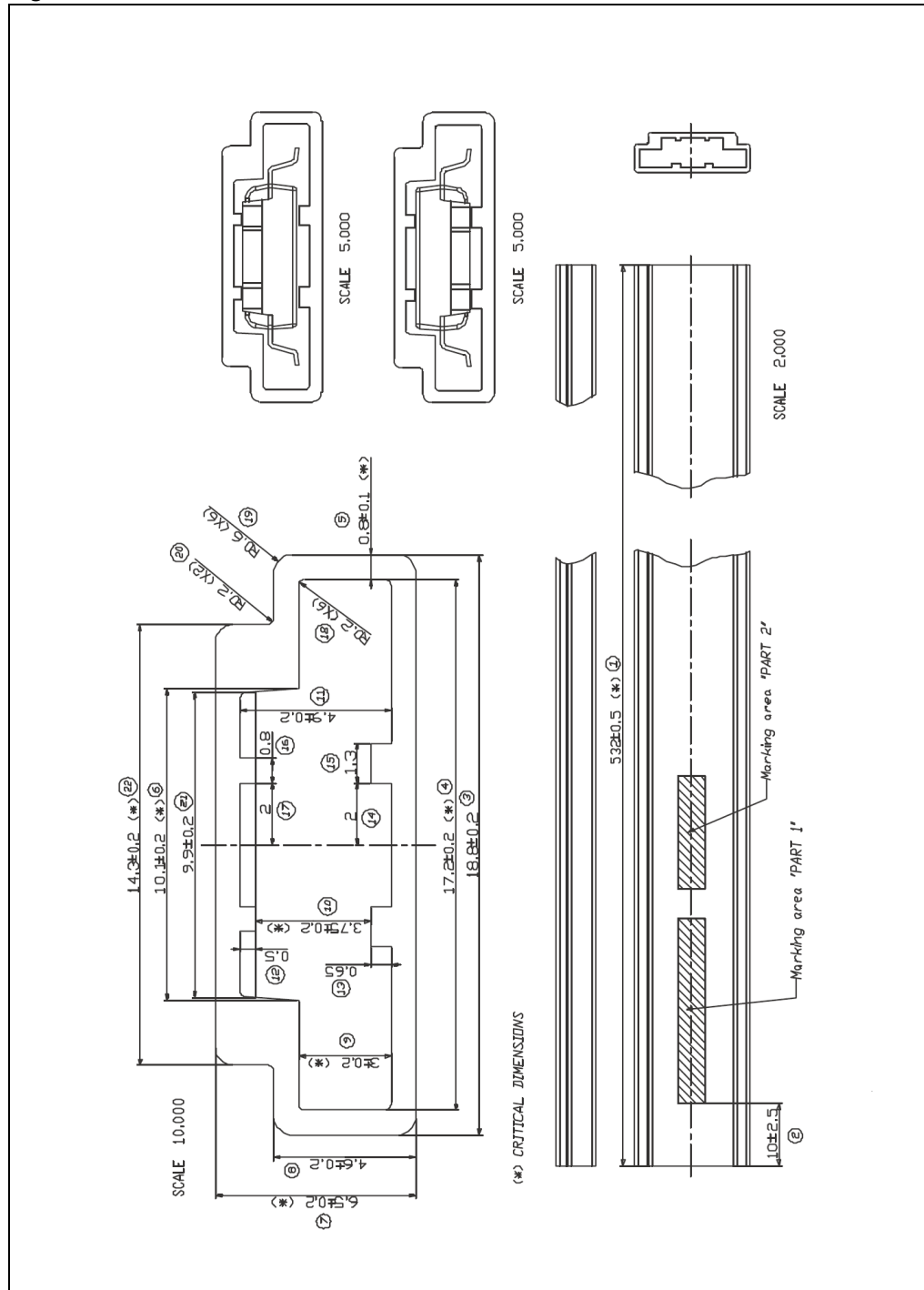
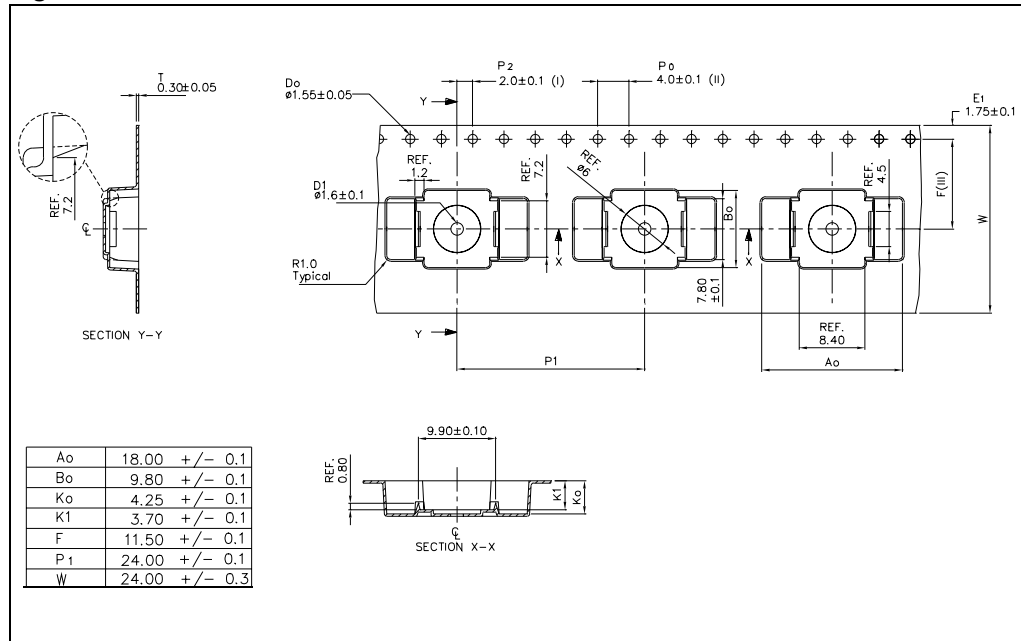

Figure 31. Reel information



9 Revision history

Table 19. Document revision history

Date	Revision	Changes
06-Apr-2006	1	Initial release.
21-May-2010	2	Added: Table 6: Moisture sensitivity level.

Please Read Carefully:

Information in this document is provided solely in connection with ST products. STMicroelectronics NV and its subsidiaries ("ST") reserve the right to make changes, corrections, modifications or improvements, to this document, and the products and services described herein at any time, without notice.

All ST products are sold pursuant to ST's terms and conditions of sale.

Purchasers are solely responsible for the choice, selection and use of the ST products and services described herein, and ST assumes no liability whatsoever relating to the choice, selection or use of the ST products and services described herein.

No license, express or implied, by estoppel or otherwise, to any intellectual property rights is granted under this document. If any part of this document refers to any third party products or services it shall not be deemed a license grant by ST for the use of such third party products or services, or any intellectual property contained therein or considered as a warranty covering the use in any manner whatsoever of such third party products or services or any intellectual property contained therein.

UNLESS OTHERWISE SET FORTH IN ST'S TERMS AND CONDITIONS OF SALE ST DISCLAIMS ANY EXPRESS OR IMPLIED WARRANTY WITH RESPECT TO THE USE AND/OR SALE OF ST PRODUCTS INCLUDING WITHOUT LIMITATION IMPLIED WARRANTIES OF MERCHANTABILITY, FITNESS FOR A PARTICULAR PURPOSE (AND THEIR EQUIVALENTS UNDER THE LAWS OF ANY JURISDICTION), OR INFRINGEMENT OF ANY PATENT, COPYRIGHT OR OTHER INTELLECTUAL PROPERTY RIGHT.

UNLESS EXPRESSLY APPROVED IN WRITING BY AN AUTHORIZED ST REPRESENTATIVE, ST PRODUCTS ARE NOT RECOMMENDED, AUTHORIZED OR WARRANTED FOR USE IN MILITARY, AIR CRAFT, SPACE, LIFE SAVING, OR LIFE SUSTAINING APPLICATIONS, NOR IN PRODUCTS OR SYSTEMS WHERE FAILURE OR MALFUNCTION MAY RESULT IN PERSONAL INJURY, DEATH, OR SEVERE PROPERTY OR ENVIRONMENTAL DAMAGE. ST PRODUCTS WHICH ARE NOT SPECIFIED AS "AUTOMOTIVE GRADE" MAY ONLY BE USED IN AUTOMOTIVE APPLICATIONS AT USER'S OWN RISK.

Resale of ST products with provisions different from the statements and/or technical features set forth in this document shall immediately void any warranty granted by ST for the ST product or service described herein and shall not create or extend in any manner whatsoever, any liability of ST.

ST and the ST logo are trademarks or registered trademarks of ST in various countries.

Information in this document supersedes and replaces all information previously supplied.

The ST logo is a registered trademark of STMicroelectronics. All other names are the property of their respective owners.

© 2010 STMicroelectronics - All rights reserved

STMicroelectronics group of companies

Australia - Belgium - Brazil - Canada - China - Czech Republic - Finland - France - Germany - Hong Kong - India - Israel - Italy - Japan - Malaysia - Malta - Morocco - Philippines - Singapore - Spain - Sweden - Switzerland - United Kingdom - United States of America

www.st.com

