



PD54008L-E

RF power transistors
The LdmoST Plastic family

Features

- Excellent thermal stability
- Common source configuration
- Broadband performances $P_{OUT} = 8W$ with 15 dB gain @ 500MHz
- New leadless plastic package
- EDS protection
- Supplied in tape & reel of 3K units
- In compliance with the 2002/93/EC european directive

Description

The PD54008L-E is a common source N-Channel, enhancement-mode lateral Field-Effect RF power transistor. It is designed for high gain, broad band commercial and industrial applications. It operates at 7 V in common source mode at frequencies of up to 1 GHz. PD54008L-E boasts the excellent gain, linearity and reliability of STH1LV latest LDMOS technology mounted in the innovative leadless SMD plastic package, PowerFLAT™.

PD54008L-E's superior linearity performance makes it an ideal solution for portable radio.

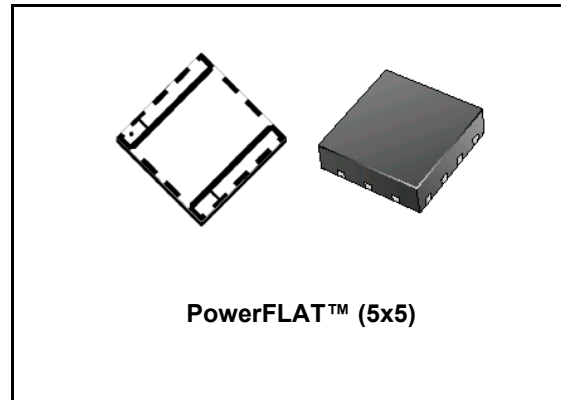

Pin connection

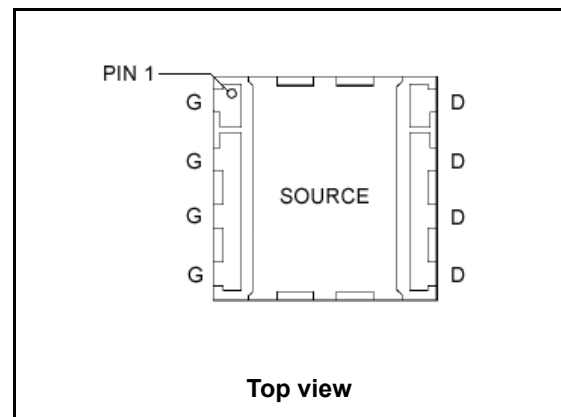

Order codes

Part Number	Marking	Package	Packaging
PD54008L-E	54008	PowerFLAT (5x5)	Tape & Reel

Contents

1	Electrical data	3
	1.1 Maximum ratings	3
	1.2 Thermal data	3
	1.3 Electrical characteristics	4
2	Impedances	5
3	Typical performance	6
	3.1 Typical performance (Broadband)	7
4	Test circuit schematic	8
5	Package mechanical data	10
6	Revision history	14

1 Electrical data

1.1 Maximum ratings

Table 1. Absolute maximum ratings ($T_{CASE} = 25^{\circ}C$)

Symbol	Parameter	Value	Unit
$V_{(BR)DSS}$	Drain source voltage	25	V
V_{GS}	Gate-source voltage	-0.5 to +15	V
I_D	Drain current	5	A
P_{DISS}	Power dissipation ($t_{CASE} = 70^{\circ}C$)	26.7	W
T_J	Maximum operating junction temperature	150	$^{\circ}C$
T_{STG}	Storage temperature	-65 to +150	$^{\circ}C$

1.2 Thermal data

Table 2. Thermal data

Symbol	Parameter	Value	Unit
R_{thJC}	Junction to case thermal resistance	3	$^{\circ}C/W$

1.3 Electrical characteristics

Table 3. Static ($T_{CASE} = 25^{\circ}C$)

Symbol	Test conditions		Min	Typ	Max	Unit
I_{DSS}	$V_{GS} = 0V$	$V_{DS} = 25V$			1	μA
I_{GSS}	$V_{GS} = 5V$	$V_{DS} = 0V$			1	μA
$V_{GS(Q)}$	$V_{DS} = 10V$	$I_D = 50mA$	2.0		5.0	V
$V_{DS(ON)}$	$V_{GS} = 10V$	$I_D = 0.5A$		0.09		V
C_{ISS}	$V_{GS} = 0V$	$V_{DS} = 7.5V$		80		pF
C_{OSS}	$V_{GS} = 0V$	$V_{DS} = 7.5V$		60		pF
C_{RSS}	$V_{GS} = 0V$	$V_{DS} = 7.5V$		6.6		pF

Table 4. Dynamic

Symbol	Test conditions		Min.	Typ.	Max.	Unit
P_{1dB}	$V_{DD} = 7.5 V$	$I_{DQ} = 200 mA$ $f = 500MHz$	8			W
G_{PS}	$V_{DD} = 7.5 V$	$I_{DQ} = 200 mA$ $P_{OUT} = 8 W$ $f = 500MHz$	15			dB
η_D	$V_{DD} = 7.5 V$	$I_{DQ} = 200 mA$ $P_{OUT} = 8 W$ $f = 500MHz$	50			%
Load Mismatch	$V_{DD} = 7.5 V$	$I_{DQ} = 200 mA$ $P_{OUT} = 8W$ $f = 500MHz$ All Phase Angles	20:1			VSW R

Table 5. ESD protection characteristics

Test conditions	Class
Human body model	2
Machine model	M3

Table 6. Moisture sensitivity level

Test methodology	Rating
J-STD-020B	MSL 3

2 Impedances

Figure 1. Impedance data schematic

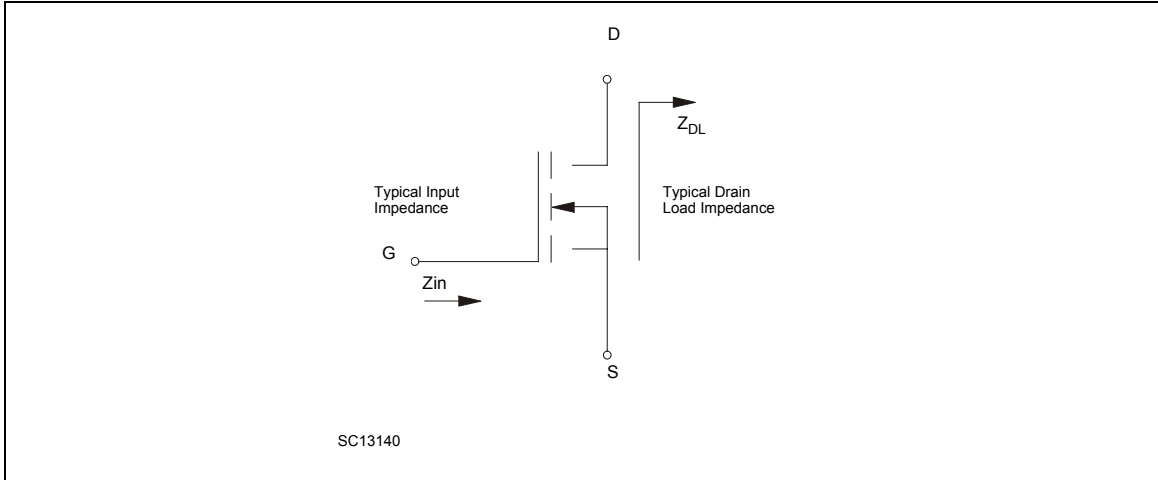

Table 7. Impedance data (1)

f	$Z_{IN} (\Omega)$	$Z_{DL} (\Omega)$
480MHz	1.12 - j 2.02	2.01 + j 0.13
500MHz	1.3 - j 2.01	1.84 + j 0.7
520MHz	1.66 - j 2.55	1.66 + j 1.51

1. In Broadband amplifier

3 Typical performance

Figure 2. Power gain vs output power

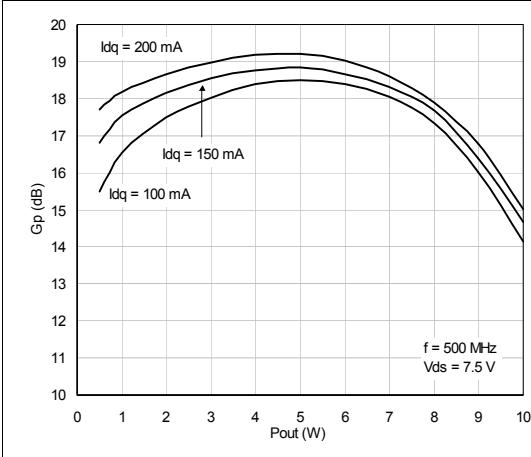

Figure 3. Efficiency vs output power

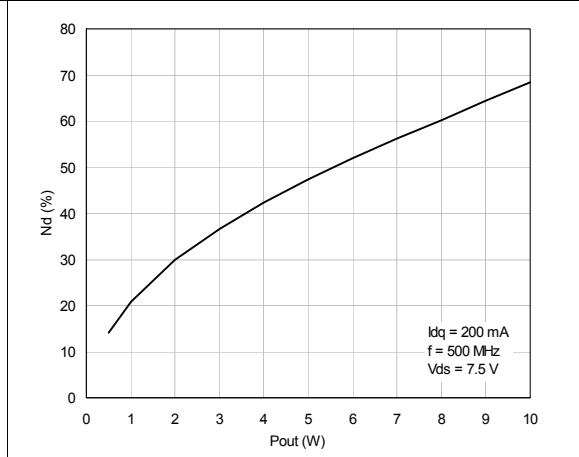

Figure 4. Return loss vs output power

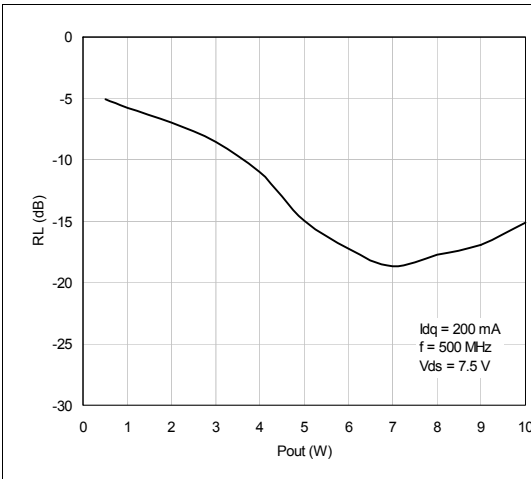
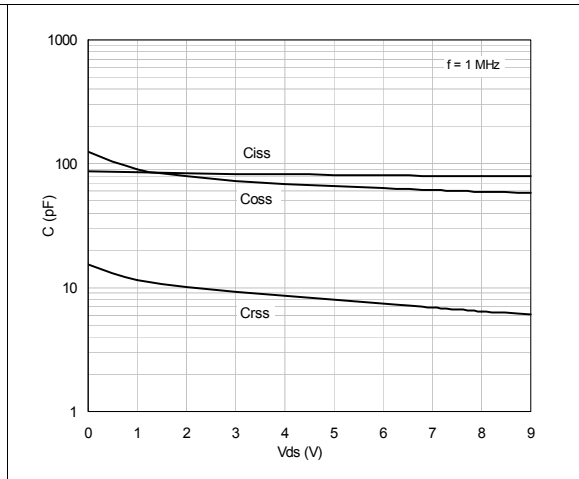

Figure 5. Capacitance vs supply voltage



3.1 Typical performance (Broadband)

Figure 6. Power gain vs frequency

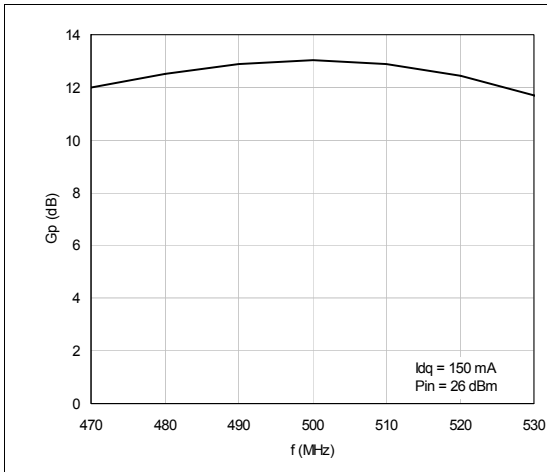

Figure 7. Efficiency vs frequency

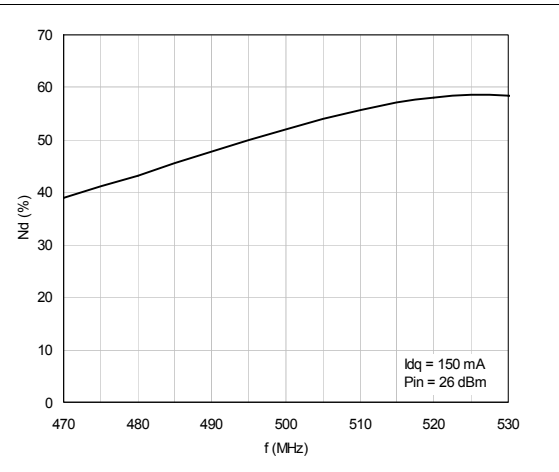
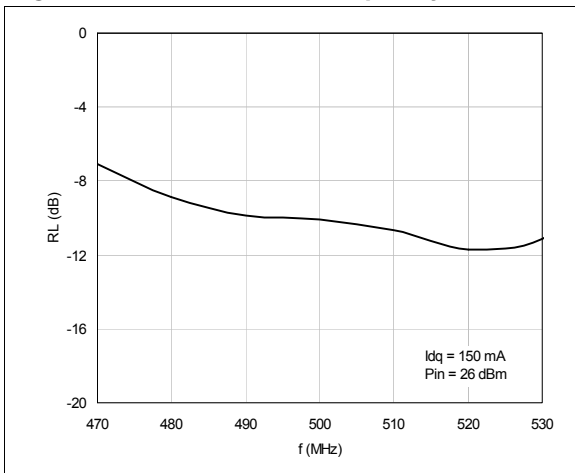

Figure 8. Return loss vs frequency



4 Test circuit schematic

Figure 9. Internal schematic

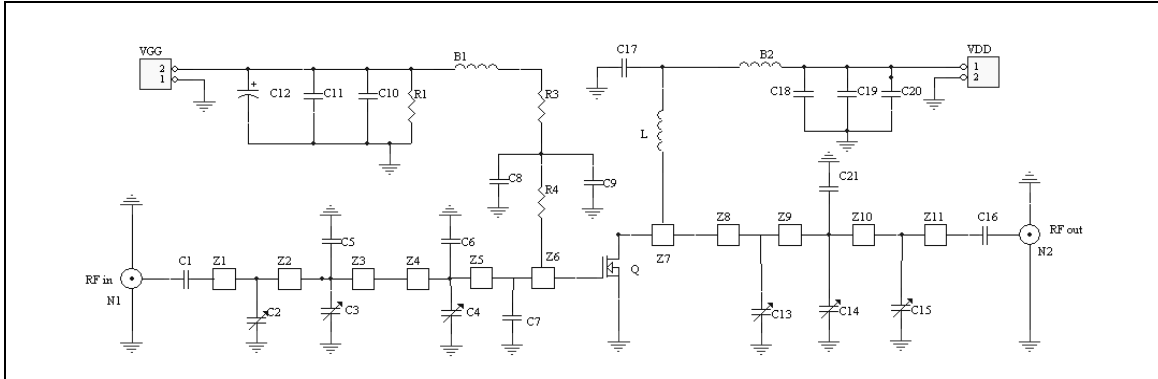

Table 8. Test circuit component part list

Component	Description
B1, B2	Ferrite bead
C1, C16	300 pF, 100 mil ATC
C2, C3, C4, C13,C14	1 -:- 20 pF Trimmer cap - JOHANSON
C15	0.8 -:- 10 pF Trimmer cap - JOHANSON
C5	36 pF, 100 mil ATC
C6	51 pF, 100 mil ATC
C7	62 pF, 100 mil ATC
C8, C17	150 pF, 100 mil CHIP CAP
C9	1 nF, 100 mil CHIP CAP
C10, C18	1000 pF, 100 mil CHIP CAP
C11, C19	0.1 nF, 100 mil CHIP CAP
C12, C20	10 μ F 50 V Electrolytic Capacitor
C21	15 pF, 100 mil ATC
L	43nH, Coilcraft
R1	33 K Ω , 1W CHIP Resistor
R3	1 K Ω , 1W CHIP Resistor
R4	15 Ω , 1W CHIP Resistor
Z1	0.49" X 0.080" MICROSTRIP
Z2	1.024" X 0.080" MICROSTRIP
Z3	0.079" X 0.080" MICROSTRIP
Z4	0.24" X 0.223" MICROSTRIP
Z5	0.079" X 0.223" MICROSTRIP

Table 8. Test circuit component part list

Z6	0.138" X 0.223" MICROSTRIP
Z7	0.259" X 0.223" MICROSTRIP
Z8	0.079" X 0.080" MICROSTRIP
Z9	0.413" X 0.080" MICROSTRIP
Z10	0.756" X 0.080" MICROSTRIP
Z11	0.61" X 0.080" MICROSTRIP
N1, N2	Type N Flange Mount
Board	ROGER, ULTRA LAM 2000 THK 0.030", $\epsilon_r = 2.55$ 2oz. ED cu SIDES

5 Package mechanical data

In order to meet environmental requirements, ST offers these devices in ECOPACK® packages. These packages have a Lead-free second level interconnect . The category of second level interconnect is marked on the package and on the inner box label, in compliance with JEDEC Standard JESD97. The maximum ratings related to soldering conditions are also marked on the inner box label. ECOPACK is an ST trademark. ECOPACK specifications are available at: www.st.com

Table 9. PowerFLAT™ mechanical data

Dim.	mm			inch		
	Min.	Typ.	Max.	Min.	Typ.	Max.
A		0.90	1.00		0.035	0.039
A1		0.02	0.05		0.001	0.002
A3		0.24			0.009	
AA	0.15	0.25	0.35	0.006	0.01	0.014
b	0.43	0.51	0.58	0.017	0.020	0.023
c	0.64	0.71	0.79	0.025	0.028	0.031
D		5.00			0.197	
d		0.30			0.011	
E		5.00			0.197	
E2	2.49	2.57	2.64	0.098	0.101	0.104
e		1.27			0.050	
f		3.37			0.132	
g		0.74			0.03	
h		0.21			0.008	

Figure 10. PowerFLAT™ package dimensions

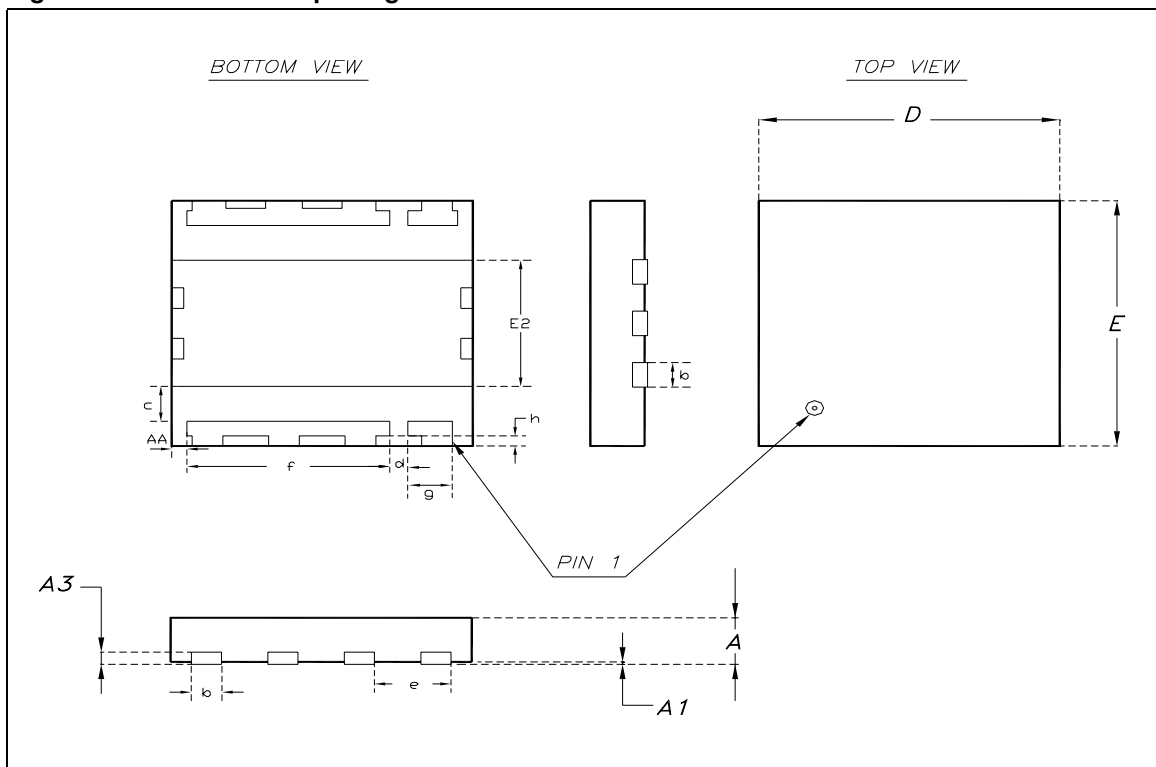

Table 10. PowerFLAT™ tape & reel dimensions

DIM.	mm.		
	Min.	Typ	Max.
Ao	5.15	5.25	5.35
Bo	5.15	5.25	5.35
Ko	1.0	1.1	1.2

Figure 11. PowerFLAT™ tape & reel

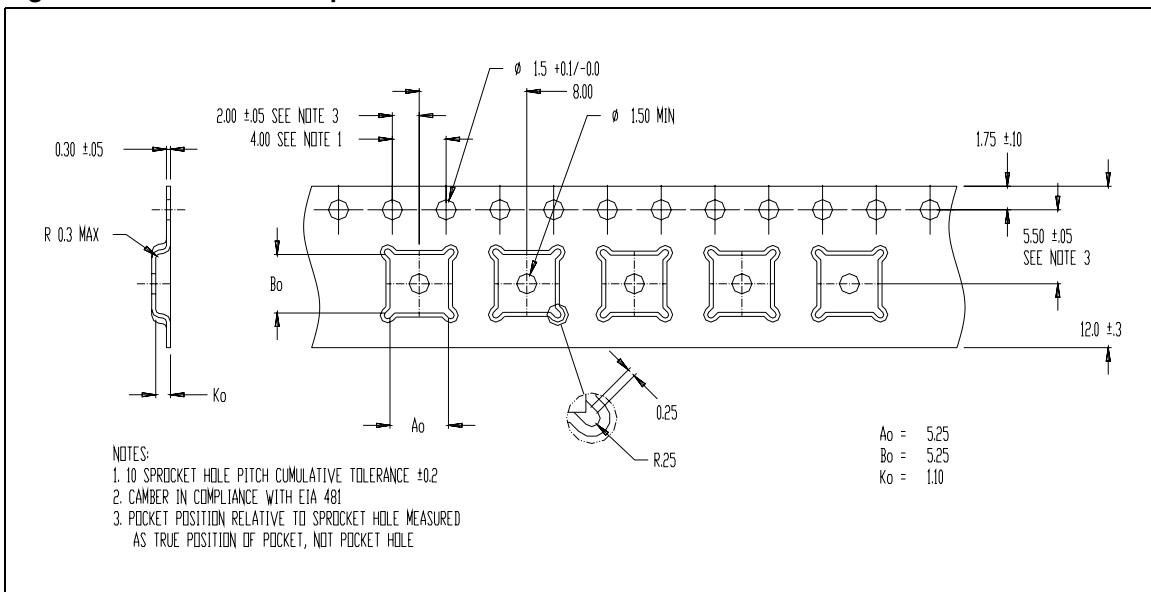
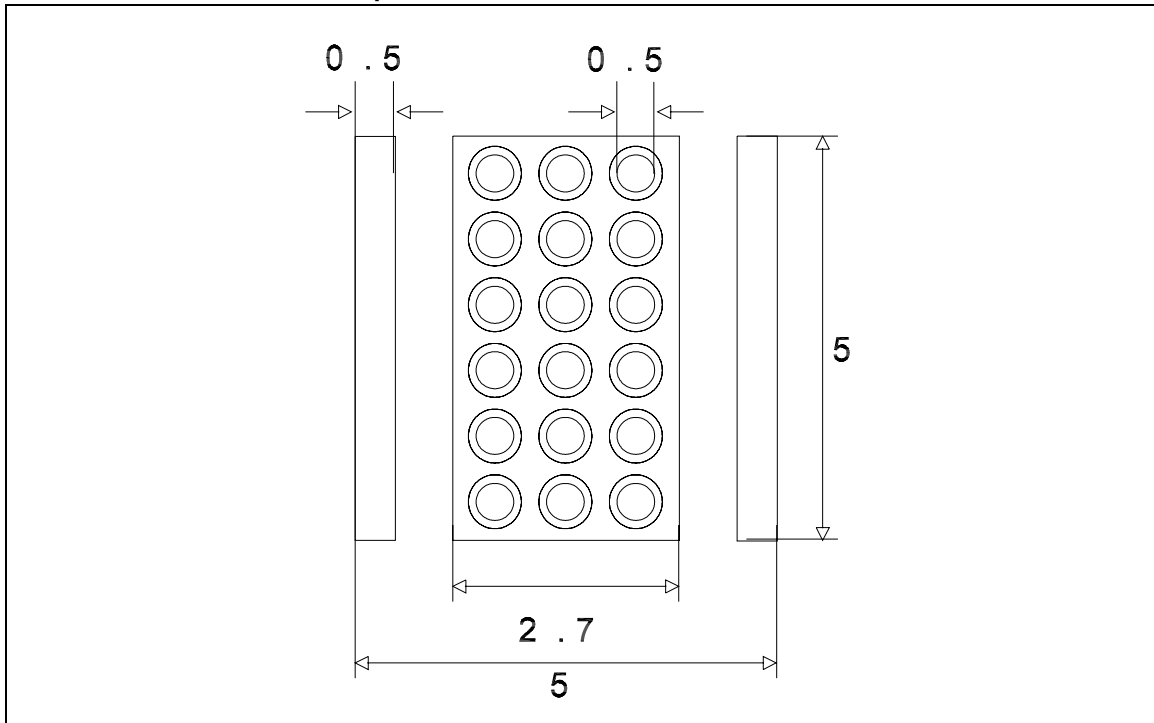

Table 11. Recommended footprint



6 Revision history

Table 12. Revision history

Date	Revision	Changes
19-Jan-2006	1	First Issue
23-Jan-2007	2	Document has been reformatted

Please Read Carefully:

Information in this document is provided solely in connection with ST products. STMicroelectronics NV and its subsidiaries ("ST") reserve the right to make changes, corrections, modifications or improvements, to this document, and the products and services described herein at any time, without notice.

All ST products are sold pursuant to ST's terms and conditions of sale.

Purchasers are solely responsible for the choice, selection and use of the ST products and services described herein, and ST assumes no liability whatsoever relating to the choice, selection or use of the ST products and services described herein.

No license, express or implied, by estoppel or otherwise, to any intellectual property rights is granted under this document. If any part of this document refers to any third party products or services it shall not be deemed a license grant by ST for the use of such third party products or services, or any intellectual property contained therein or considered as a warranty covering the use in any manner whatsoever of such third party products or services or any intellectual property contained therein.

UNLESS OTHERWISE SET FORTH IN ST'S TERMS AND CONDITIONS OF SALE ST DISCLAIMS ANY EXPRESS OR IMPLIED WARRANTY WITH RESPECT TO THE USE AND/OR SALE OF ST PRODUCTS INCLUDING WITHOUT LIMITATION IMPLIED WARRANTIES OF MERCHANTABILITY, FITNESS FOR A PARTICULAR PURPOSE (AND THEIR EQUIVALENTS UNDER THE LAWS OF ANY JURISDICTION), OR INFRINGEMENT OF ANY PATENT, COPYRIGHT OR OTHER INTELLECTUAL PROPERTY RIGHT.

UNLESS EXPRESSLY APPROVED IN WRITING BY AN AUTHORIZED ST REPRESENTATIVE, ST PRODUCTS ARE NOT RECOMMENDED, AUTHORIZED OR WARRANTED FOR USE IN MILITARY, AIR CRAFT, SPACE, LIFE SAVING, OR LIFE SUSTAINING APPLICATIONS, NOR IN PRODUCTS OR SYSTEMS WHERE FAILURE OR MALFUNCTION MAY RESULT IN PERSONAL INJURY, DEATH, OR SEVERE PROPERTY OR ENVIRONMENTAL DAMAGE. ST PRODUCTS WHICH ARE NOT SPECIFIED AS "AUTOMOTIVE GRADE" MAY ONLY BE USED IN AUTOMOTIVE APPLICATIONS AT USER'S OWN RISK.

Resale of ST products with provisions different from the statements and/or technical features set forth in this document shall immediately void any warranty granted by ST for the ST product or service described herein and shall not create or extend in any manner whatsoever, any liability of ST.

ST and the ST logo are trademarks or registered trademarks of ST in various countries.

Information in this document supersedes and replaces all information previously supplied.

The ST logo is a registered trademark of STMicroelectronics. All other names are the property of their respective owners.

© 2007 STMicroelectronics - All rights reserved

STMicroelectronics group of companies

Australia - Belgium - Brazil - Canada - China - Czech Republic - Finland - France - Germany - Hong Kong - India - Israel - Italy - Japan - Malaysia - Malta - Morocco - Singapore - Spain - Sweden - Switzerland - United Kingdom - United States of America

www.st.com

