

CGH40010

10 W, RF Power GaN HEMT

Cree's CGH40010 is an unmatched, gallium nitride (GaN) high electron mobility transistor (HEMT). The CGH40010, operating from a 28 volt rail, offers a general purpose, broadband solution to a variety of RF and microwave applications. GaN HEMTs offer high efficiency, high gain and wide bandwidth capabilities making the CGH40010 ideal for linear and compressed amplifier circuits. The transistor is available in both screw-down, flange and solder-down, pill packages.

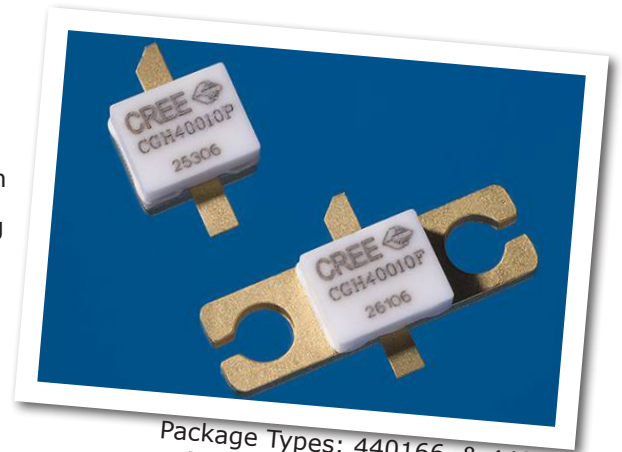

Package Types: 440166, & 440196
PN's: CGH40010F & CGH40010P

FEATURES

- Up to 6 GHz Operation
- 16 dB Small Signal Gain at 2.0 GHz
- 14 dB Small Signal Gain at 4.0 GHz
- 13 W typical P_{SAT}
- 65 % Efficiency at P_{SAT}
- 28 V Operation

APPLICATIONS

- 2-Way Private Radio
- Broadband Amplifiers
- Cellular Infrastructure
- Test Instrumentation
- Class A, AB, Linear amplifiers suitable for OFDM, W-CDMA, EDGE, CDMA waveforms



Large Signal Models Available for SiC & GaN



Absolute Maximum Ratings (not simultaneous) at 25 °C Case Temperature

Parameter	Symbol	Rating	Units
Drain-Source Voltage	V_{DSS}	84	Volts
Gate-to-Source Voltage	V_{GS}	-10, +2	Volts
Storage Temperature	T_{STG}	-65, +150	°C
Operating Junction Temperature	T_J	225	°C
Maximum Forward Gate Current	I_{GMAX}	4.0	mA
Soldering Temperature ¹	T_S	245	°C
Screw Torque	τ	60	in-oz
Thermal Resistance, Junction to Case ²	$R_{\theta JC}$	8.0	°C/W
Case Operating Temperature ^{2,3}	T_C	-40, +150	°C

Note:

¹ Refer to the Application Note on soldering at www.cree.com/products/wireless_appnotes.asp

² Measured for the CGH40010F at $P_{DISS} = 14$ W.

³ See also, the Power Dissipation De-rating Curve on Page 6.

Electrical Characteristics ($T_c = 25^\circ\text{C}$)

Characteristics	Symbol	Min.	Typ.	Max.	Units	Conditions
DC Characteristics¹						
Gate Threshold Voltage	$V_{GS(th)}$	-3.8	-3.3	-2.3	V_{DC}	$V_{DS} = 10$ V, $I_D = 3.6$ mA
Gate Quiescent Voltage	$V_{GS(Q)}$	-	-3.0	-	V_{DC}	$V_{DS} = 28$ V, $I_D = 200$ mA
Saturated Drain Current	I_{DS}	2.9	3.5	-	A	$V_{DS} = 6.0$ V, $V_{GS} = 2.0$ V
Drain-Source Breakdown Voltage	V_{BR}	120	-	-	V_{DC}	$V_{GS} = -8$ V, $I_D = 3.6$ mA
RF Characteristics² ($T_c = 25^\circ\text{C}$, $F_0 = 3.7$ GHz unless otherwise noted)						
Small Signal Gain	G_{SS}	12.5	14.5	-	dB	$V_{DD} = 28$ V, $I_{DQ} = 200$ mA
Power Output ³	P_{SAT}	10	12.5	-	W	$V_{DD} = 28$ V, $I_{DQ} = 200$ mA
Drain Efficiency ⁴	η	55	65	-	%	$V_{DD} = 28$ V, $I_{DQ} = 200$ mA, P_{SAT}
Output Mismatch Stress	VSWR	-	-	10 : 1	Ψ	No damage at all phase angles, $V_{DD} = 28$ V, $I_{DQ} = 200$ mA, $P_{OUT} = 10$ W CW
Dynamic Characteristics						
Input Capacitance	C_{GS}	-	4.5	-	pF	$V_{DS} = 28$ V, $V_{gs} = -8$ V, $f = 1$ MHz
Output Capacitance	C_{DS}	-	1.3	-	pF	$V_{DS} = 28$ V, $V_{gs} = -8$ V, $f = 1$ MHz
Feedback Capacitance	C_{GD}	-	0.2	-	pF	$V_{DS} = 28$ V, $V_{gs} = -8$ V, $f = 1$ MHz

Notes:

¹ Measured on wafer prior to packaging.

² Measured in CGH40010-TB.

³ P_{SAT} is defined as $I_G = 0.36$ mA.

⁴ Drain Efficiency = P_{OUT} / P_{DC}

Typical Performance

Small Signal Gain and Return Loss vs Frequency of the CGH40010 in the CGH40010-TB

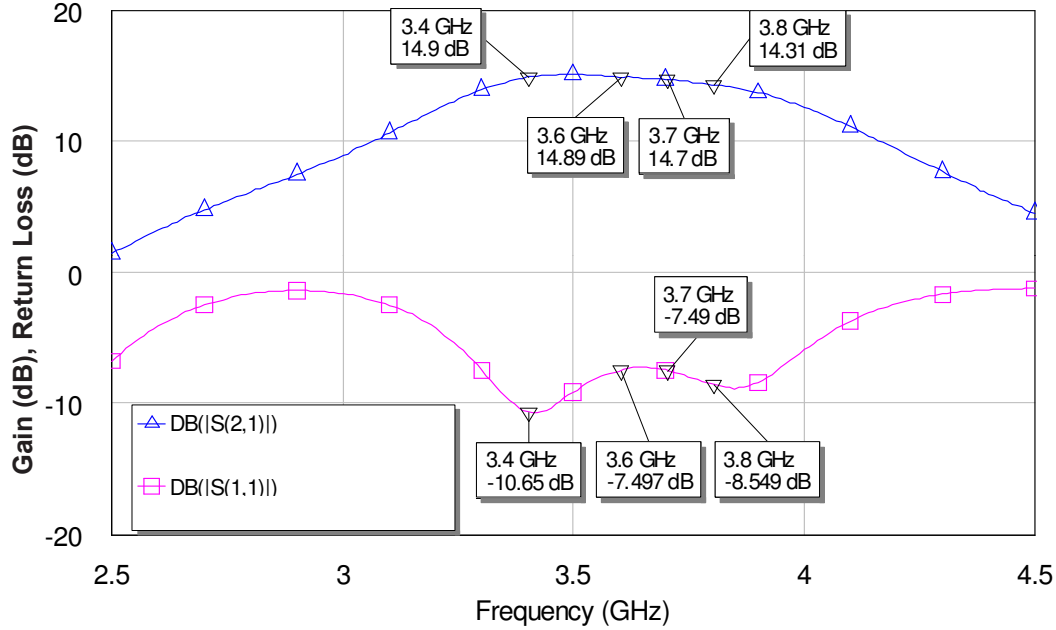

P_{SAT} Gain, and Drain Efficiency vs Frequency of the CGH40010F in the CGH40010-TB
 $V_{DD} = 28\text{ V}$, $I_{DQ} = 200\text{ mA}$

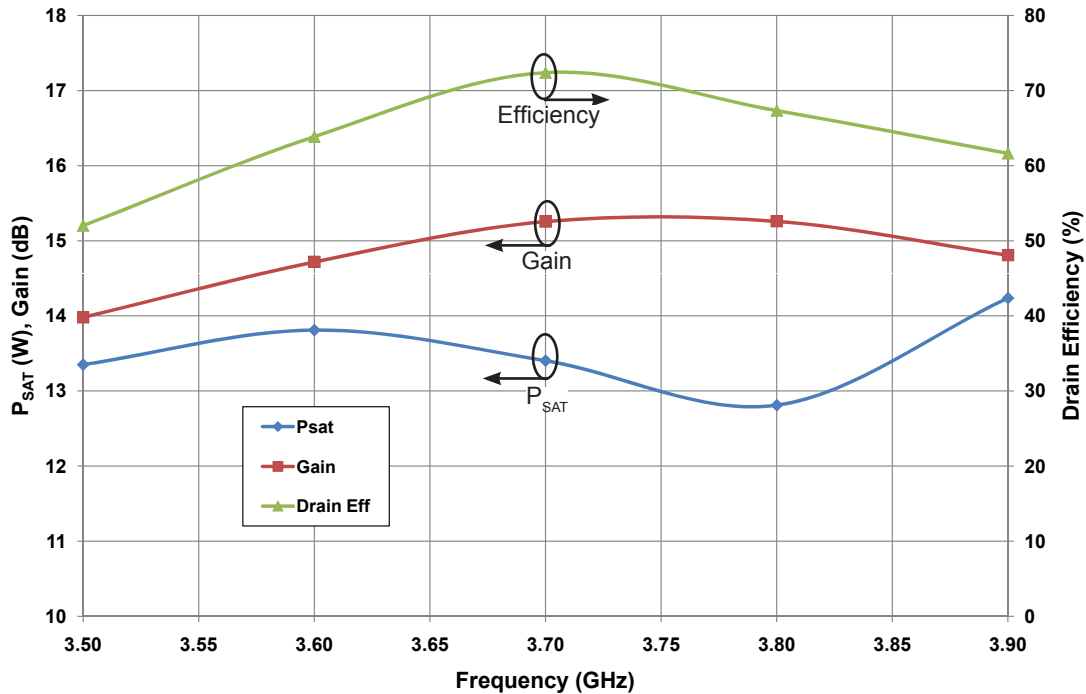

Typical Performance

Swept CW Data of CGH40010F vs. Output Power with Source and Load Impedances Optimized for Drain Efficiency at 2.0 GHz
 $V_{DD} = 28\text{ V}$, $I_{DQ} = 200\text{ mA}$

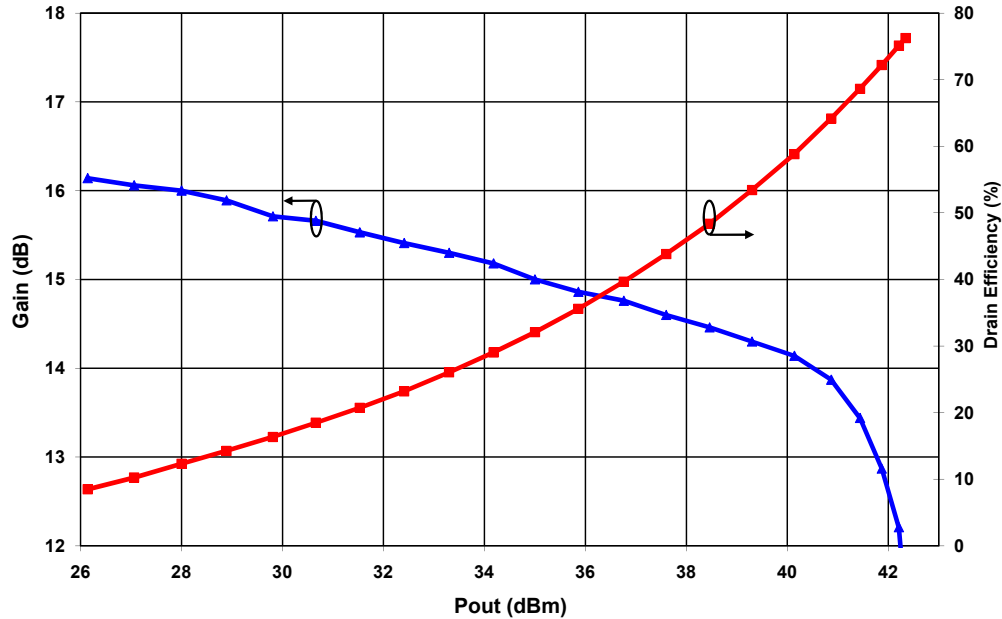

Swept CW Data of CGH40010F vs. Output Power with Source and Load Impedances Optimized for Drain Efficiency at 3.6 GHz
 $V_{DD} = 28\text{ V}$, $I_{DQ} = 200\text{ mA}$

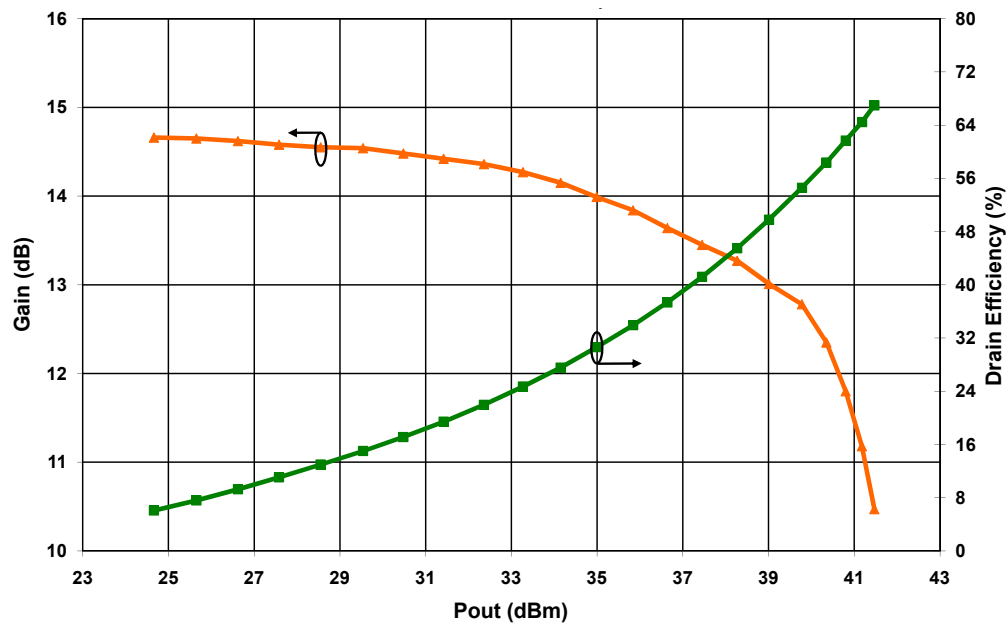

Typical Performance

Swept CW Data of CGH40010F vs. Output Power with Source and Load Impedances Optimized for P1 Power at 3.6 GHz
 $V_{DD} = 28\text{ V}$, $I_{DQ} = 200\text{ mA}$

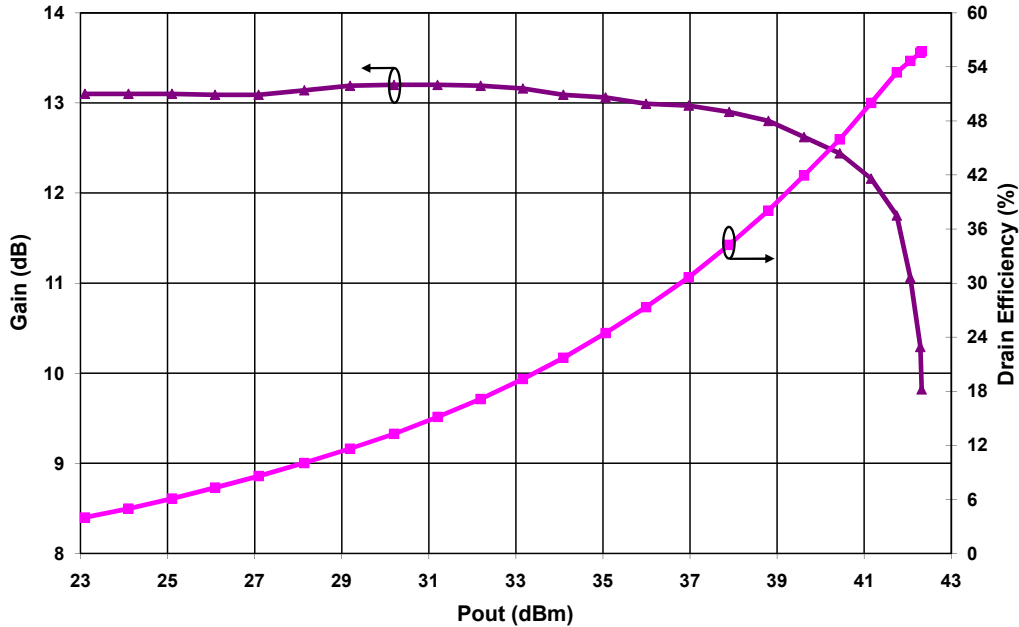

Simulated Maximum Available Gain and K Factor of the CGH40010F
 $V_{DD} = 28\text{ V}$, $I_{DQ} = 200\text{ mA}$

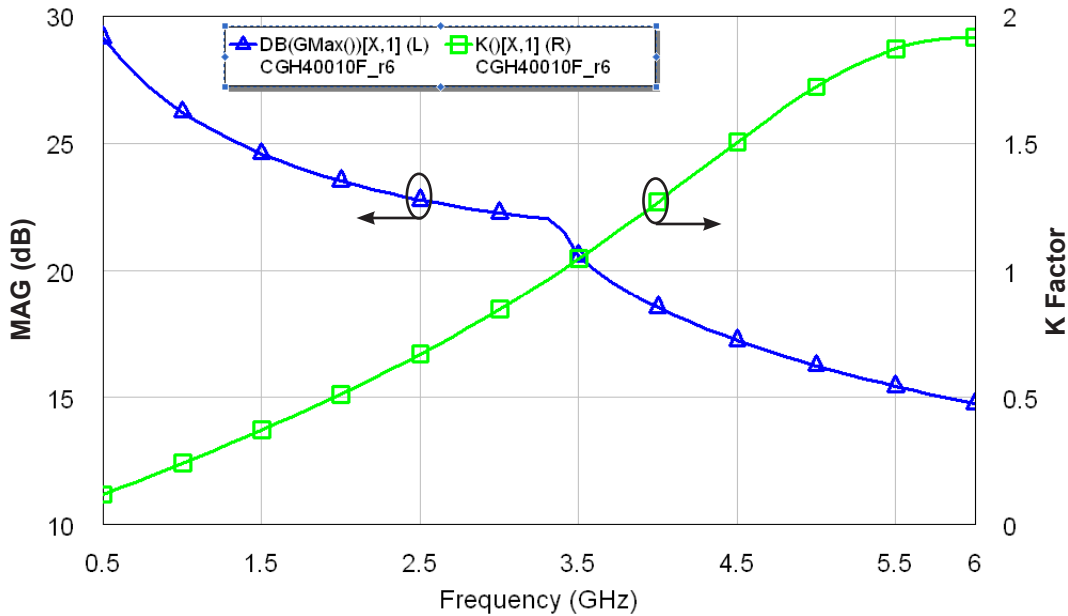

Typical Noise Performance

Simulated Minimum Noise Figure and Noise Resistance vs Frequency of the CGH40010F
 $V_{DD} = 28\text{ V}, I_{DQ} = 100\text{ mA}$

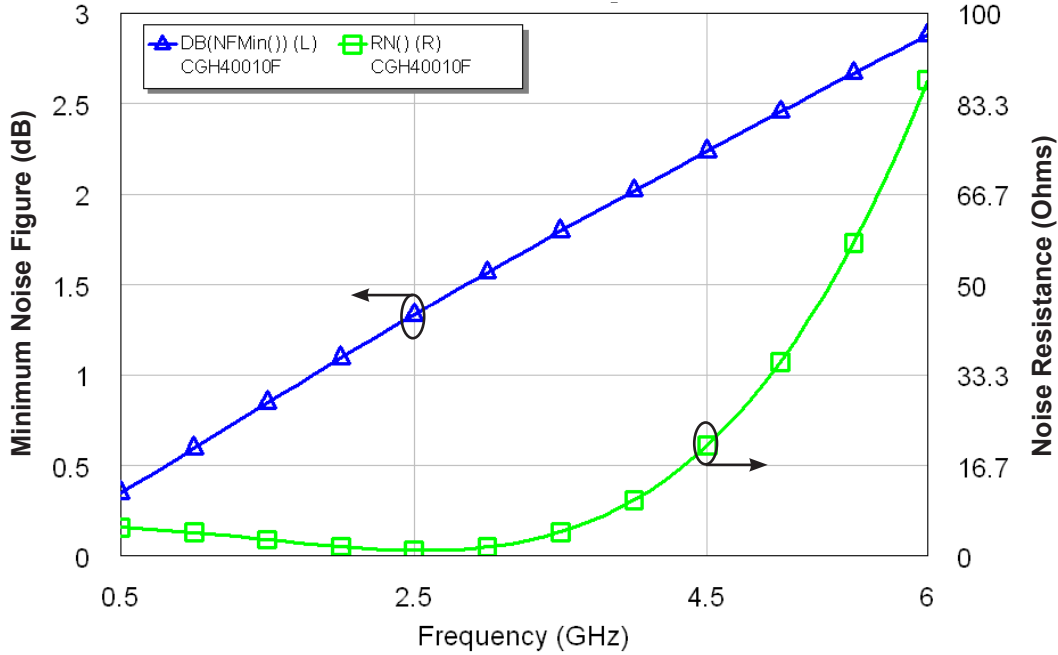

Electrostatic Discharge (ESD) Classifications

Parameter	Symbol	Class	Test Methodology
Human Body Model	HBM	1A > 250 V	JEDEC JESD22 A114-D
Charge Device Model	CDM	1 < 200 V	JEDEC JESD22 C101-C

Source and Load Impedances

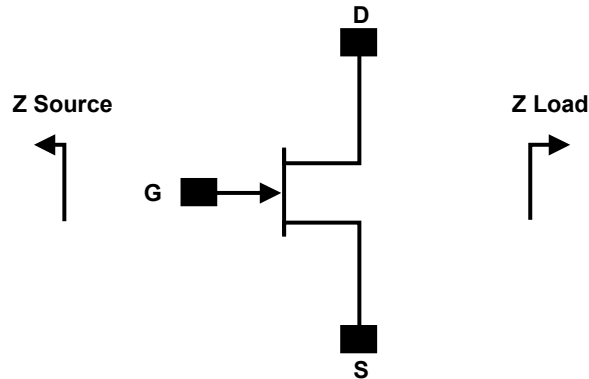

Frequency (MHz)	Z Source	Z Load
500	20.2 + j16.18	51.7 + j15.2
1000	8.38 + j9.46	41.4 + j28.5
1500	7.37 + j0	28.15 + j29
2500	3.19 - j4.76	19 + j9.2
3500	3.18 - j13.3	14.6 + j7.46

Note 1. $V_{DD} = 28V$, $I_{DQ} = 200mA$ in the 440166 package.

Note 2. Optimized for power, gain, P_{SAT} and PAE.

Note 3. When using this device at low frequency, series resistors should be used to maintain amplifier stability.

CGH40010 Power Dissipation De-rating Curve

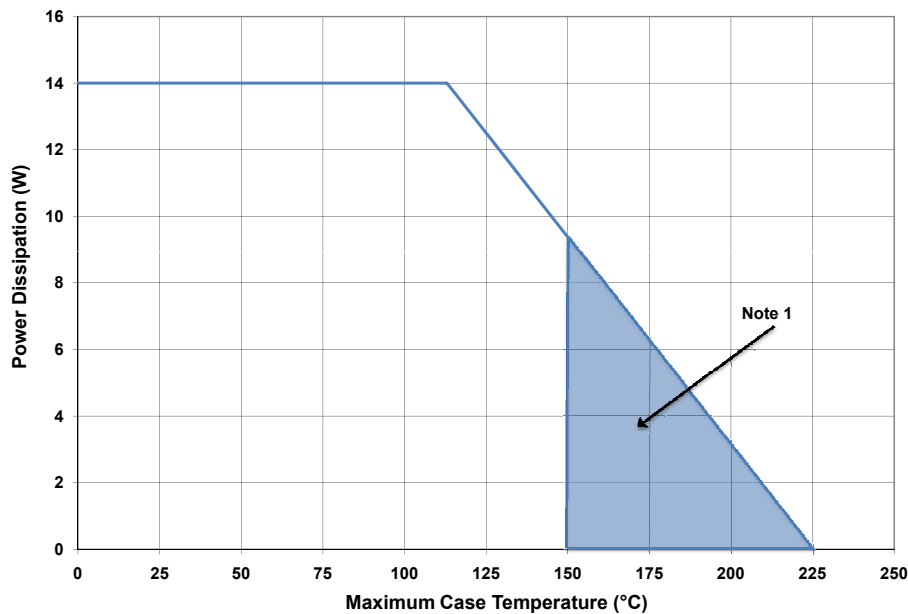

Note 1. Area exceeds Maximum Case Operating Temperature (See Page 2).

CGH40010-TB Demonstration Amplifier Circuit Bill of Materials

Designator	Description	Qty
R1,R2	RES,1/16W,0603,1%,0 OHMS	1
R3	RES,1/16W,0603,1%,47 OHMS	1
R4	RES,1/16W,0603,1%,100 OHMS	1
C6	CAP, 470PF, 5%,100V, 0603	1
C17	CAP, 33 UF, 20%, G CASE	1
C16	CAP, 1.0UF, 100V, 10%, X7R, 1210	1
C8	CAP 10UF 16V TANTALUM	1
C14	CAP, 100.0pF, +/-5%, 0603	1
C1	CAP, 0.5pF, +/-0.05pF, 0603	1
C2	CAP, 0.7pF, +/-0.1pF, 0603	1
C10,C11	CAP, 1.0pF, +/-0.1pF, 0603	2
C4,C12	CAP, 10.0pF,+/-5%, 0603	2
C5,C13	CAP, 39pF, +/-5%, 0603	2
C7,C15	CAP,33000PF, 0805,100V, X7R	2
J3,J4	CONN SMA STR PANEL JACK RECP	1
J2	HEADER RT>PLZ.1CEN LK 2 POS	1
J1	HEADER RT>PLZ .1CEN LK 5POS	1
-	PCB, RO4350B, Er = 3.48, h = 20 mil	1
Q1	CGH40010F or CGH40010P	1

CGH40010-TB Demonstration Amplifier Circuit

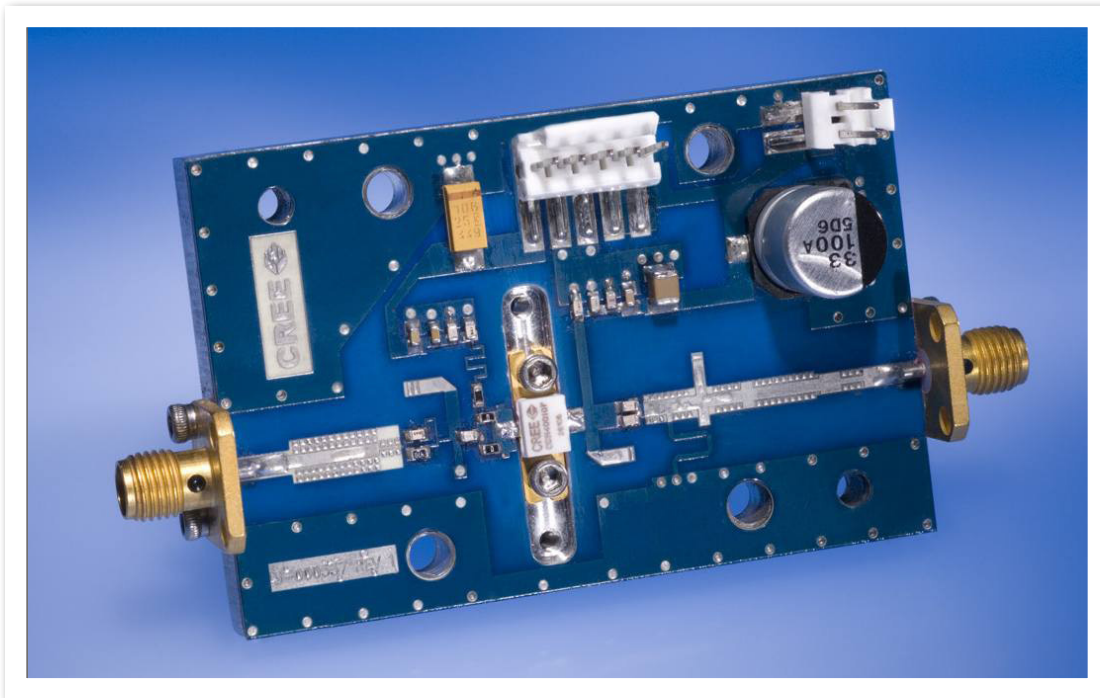

CGH40010-TB Demonstration Amplifier Circuit Schematic

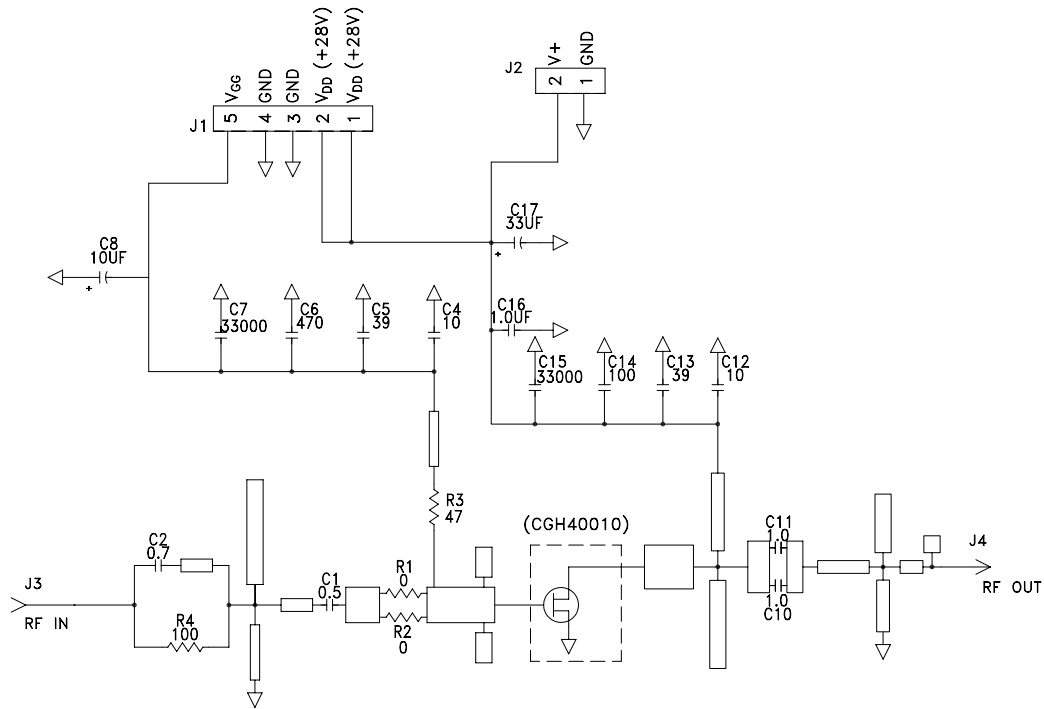

CGH40010-TB Demonstration Amplifier Circuit Outline

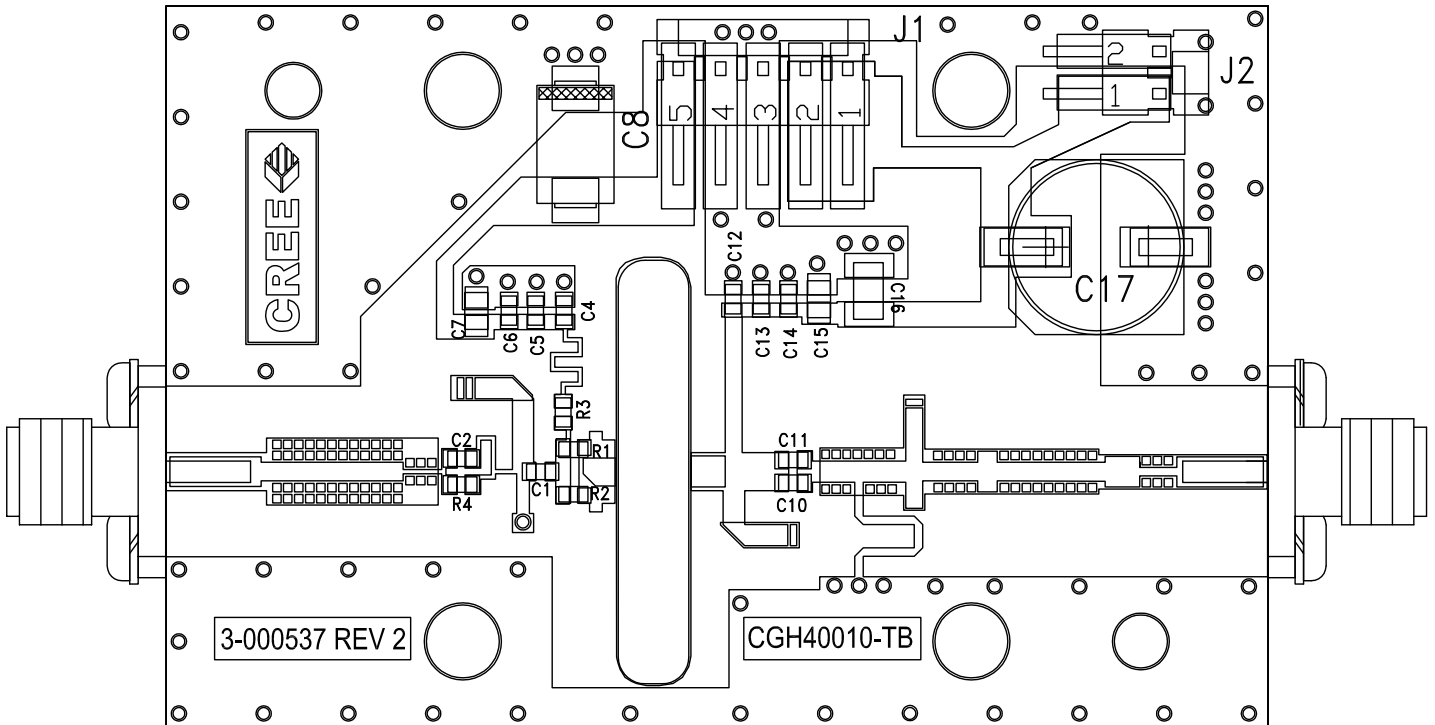



Typical Package S-Parameters for CGH40010
(Small Signal, $V_{DS} = 28\text{ V}$, $I_{DQ} = 100\text{ mA}$, angle in degrees)

Frequency	Mag S11	Ang S11	Mag S21	Ang S21	Mag S12	Ang S12	Mag S22	Ang S22
500 MHz	0.909	-123.34	17.19	108.22	0.027	21.36	0.343	-90.81
600 MHz	0.902	-133.06	14.86	101.82	0.028	15.60	0.329	-98.65
700 MHz	0.897	-140.73	13.04	96.45	0.028	10.87	0.321	-104.84
800 MHz	0.894	-146.96	11.58	91.78	0.029	6.84	0.317	-109.84
900 MHz	0.891	-152.16	10.41	87.61	0.029	3.33	0.316	-113.95
1.0 GHz	0.890	-156.60	9.43	83.82	0.029	0.19	0.318	-117.42
1.1 GHz	0.889	-160.47	8.62	80.31	0.029	-2.66	0.321	-120.40
1.2 GHz	0.888	-163.90	7.93	77.02	0.029	-5.28	0.326	-123.02
1.3 GHz	0.887	-166.99	7.34	73.90	0.029	-7.72	0.332	-125.36
1.4 GHz	0.887	-169.80	6.82	70.92	0.029	-10.01	0.338	-127.51
1.5 GHz	0.887	-172.39	6.38	68.05	0.029	-12.18	0.345	-129.50
1.6 GHz	0.887	-174.80	5.98	65.28	0.028	-14.24	0.353	-131.37
1.7 GHz	0.887	-177.07	5.63	62.59	0.028	-16.21	0.360	-133.15
1.8 GHz	0.887	-179.22	5.32	59.97	0.028	-18.09	0.369	-134.87
1.9 GHz	0.887	178.73	5.04	57.41	0.028	-19.91	0.377	-136.54
2.0 GHz	0.888	176.76	4.78	54.89	0.027	-21.66	0.385	-138.17
2.1 GHz	0.888	174.86	4.55	52.42	0.027	-23.35	0.393	-139.77
2.2 GHz	0.888	173.02	4.34	49.99	0.027	-24.98	0.402	-141.34
2.3 GHz	0.888	171.23	4.15	47.60	0.026	-26.56	0.410	-142.90
2.4 GHz	0.889	169.48	3.97	45.24	0.026	-28.08	0.418	-144.45
2.5 GHz	0.889	167.76	3.81	42.90	0.026	-29.55	0.426	-145.99
2.6 GHz	0.890	166.07	3.66	40.59	0.025	-30.98	0.434	-147.53
2.7 GHz	0.890	164.39	3.53	38.30	0.025	-32.36	0.442	-149.06
2.8 GHz	0.890	162.74	3.40	36.03	0.025	-33.69	0.450	-150.59
2.9 GHz	0.891	161.10	3.28	33.78	0.024	-34.97	0.458	-152.12
3.0 GHz	0.891	159.46	3.17	31.55	0.024	-36.20	0.465	-153.65
3.2 GHz	0.892	156.21	2.97	27.12	0.023	-38.51	0.479	-156.72
3.4 GHz	0.893	152.96	2.79	22.73	0.022	-40.63	0.493	-159.80
3.6 GHz	0.893	149.69	2.64	18.38	0.022	-42.52	0.505	-162.90
3.8 GHz	0.894	146.38	2.50	14.05	0.021	-44.17	0.517	-166.03
4.0 GHz	0.894	143.03	2.38	9.72	0.020	-45.56	0.527	-169.19
4.2 GHz	0.894	139.61	2.28	5.40	0.019	-46.67	0.537	-172.39
4.4 GHz	0.895	136.11	2.18	1.07	0.019	-47.46	0.546	-175.64
4.6 GHz	0.895	132.53	2.09	-3.29	0.018	-47.90	0.554	-178.95
4.8 GHz	0.895	128.85	2.01	-7.68	0.017	-47.96	0.561	-177.69
5.0 GHz	0.895	125.06	1.94	-12.10	0.017	-47.61	0.568	174.25
5.2 GHz	0.895	121.15	1.88	-16.58	0.016	-46.84	0.573	170.72
5.4 GHz	0.895	117.11	1.82	-21.12	0.016	-45.67	0.578	167.10
5.6 GHz	0.895	112.94	1.77	-25.73	0.015	-44.12	0.582	163.38
5.8 GHz	0.895	108.62	1.72	-30.42	0.015	-42.30	0.586	159.54
6.0 GHz	0.895	104.15	1.68	-35.20	0.015	-40.33	0.589	155.56

Download this s-parameter file in ".s2p" format at http://www.cree.com/products/wireless_s-parameters.asp



Typical Package S-Parameters for CGH40010
 (Small Signal, $V_{DS} = 28\text{ V}$, $I_{DQ} = 200\text{ mA}$, angle in degrees)

Frequency	Mag S11	Ang S11	Mag S21	Ang S21	Mag S12	Ang S12	Mag S22	Ang S22
500 MHz	0.911	-130.62	18.41	105.41	0.022	19.44	0.303	-112.24
600 MHz	0.906	-139.65	15.80	99.47	0.023	14.31	0.299	-119.83
700 MHz	0.902	-146.70	13.80	94.50	0.023	10.17	0.298	-125.50
800 MHz	0.899	-152.41	12.22	90.19	0.023	6.68	0.299	-129.85
900 MHz	0.898	-157.17	10.96	86.34	0.024	3.67	0.302	-133.28
1.0 GHz	0.896	-161.24	9.92	82.82	0.024	0.99	0.305	-136.05
1.1 GHz	0.896	-164.79	9.06	79.56	0.024	-1.41	0.309	-138.34
1.2 GHz	0.895	-167.95	8.33	76.49	0.024	-3.62	0.314	-140.30
1.3 GHz	0.895	-170.80	7.70	73.57	0.023	-5.66	0.320	-142.01
1.4 GHz	0.894	-173.41	7.17	70.78	0.023	-7.56	0.326	-143.54
1.5 GHz	0.894	-175.82	6.70	68.08	0.023	-9.35	0.332	-144.94
1.6 GHz	0.894	-178.09	6.28	65.47	0.023	-11.05	0.338	-146.24
1.7 GHz	0.894	179.78	5.92	62.92	0.023	-12.66	0.345	-147.48
1.8 GHz	0.894	177.75	5.59	60.43	0.023	-14.19	0.352	-148.68
1.9 GHz	0.894	175.81	5.30	57.99	0.023	-15.65	0.358	-149.84
2.0 GHz	0.894	173.94	5.04	55.59	0.022	-17.05	0.365	-150.99
2.1 GHz	0.894	172.13	4.80	53.23	0.022	-18.39	0.372	-152.12
2.2 GHz	0.894	170.37	4.58	50.91	0.022	-19.67	0.379	-153.26
2.3 GHz	0.895	168.65	4.38	48.61	0.022	-20.90	0.386	-154.39
2.4 GHz	0.895	166.96	4.20	46.33	0.021	-22.08	0.393	-155.54
2.5 GHz	0.895	165.30	4.03	44.08	0.021	-23.20	0.400	-156.69
2.6 GHz	0.895	163.66	3.88	41.84	0.021	-24.27	0.407	-157.85
2.7 GHz	0.895	162.04	3.74	39.63	0.021	-25.28	0.414	-159.03
2.8 GHz	0.895	160.43	3.60	37.43	0.020	-26.25	0.420	-160.22
2.9 GHz	0.896	158.83	3.48	35.24	0.020	-27.16	0.427	-161.42
3.0 GHz	0.896	157.24	3.37	33.06	0.020	-28.02	0.433	-162.64
3.2 GHz	0.896	154.06	3.16	28.74	0.019	-29.57	0.446	-165.13
3.4 GHz	0.896	150.87	2.98	24.44	0.019	-30.88	0.457	-167.69
3.6 GHz	0.896	147.66	2.82	20.16	0.018	-31.95	0.468	-170.31
3.8 GHz	0.897	144.41	2.68	15.89	0.018	-32.76	0.478	-173.00
4.0 GHz	0.897	141.10	2.56	11.61	0.017	-33.30	0.488	-175.77
4.2 GHz	0.897	137.72	2.45	7.33	0.017	-33.55	0.497	-178.61
4.4 GHz	0.897	134.26	2.35	3.03	0.017	-33.50	0.505	178.47
4.6 GHz	0.897	130.71	2.26	-1.31	0.016	-33.18	0.512	175.46
4.8 GHz	0.896	127.06	2.17	-5.68	0.016	-32.58	0.518	172.36
5.0 GHz	0.896	123.30	2.10	-10.09	0.016	-31.74	0.524	169.16
5.2 GHz	0.896	119.42	2.04	-14.57	0.016	-30.72	0.529	165.86
5.4 GHz	0.896	115.41	1.98	-19.10	0.016	-29.60	0.534	162.44
5.6 GHz	0.896	111.26	1.92	-23.71	0.016	-28.46	0.537	158.89
5.8 GHz	0.895	106.97	1.87	-28.40	0.017	-27.41	0.540	155.20
6.0 GHz	0.895	102.53	1.82	-33.19	0.017	-26.54	0.543	151.36

Download this s-parameter file in ".s2p" format at http://www.cree.com/products/wireless_s-parameters.asp



Typical Package S-Parameters for CGH40010
 (Small Signal, $V_{DS} = 28\text{ V}$, $I_{DQ} = 500\text{ mA}$, angle in degrees)

Frequency	Mag S11	Ang S11	Mag S21	Ang S21	Mag S12	Ang S12	Mag S22	Ang S22
500 MHz	0.914	-135.02	18.58	103.70	0.020	18.36	0.300	-126.80
600 MHz	0.909	-143.57	15.88	98.05	0.020	13.67	0.302	-133.51
700 MHz	0.906	-150.23	13.83	93.33	0.021	9.90	0.304	-138.40
800 MHz	0.904	-155.61	12.23	89.23	0.021	6.77	0.307	-142.08
900 MHz	0.903	-160.09	10.95	85.56	0.021	4.08	0.311	-144.94
1.0 GHz	0.902	-163.93	9.91	82.21	0.021	1.71	0.314	-147.23
1.1 GHz	0.901	-167.29	9.04	79.09	0.021	-0.41	0.319	-149.10
1.2 GHz	0.901	-170.29	8.31	76.15	0.021	-2.35	0.323	-150.69
1.3 GHz	0.900	-173.00	7.69	73.35	0.021	-4.12	0.328	-152.07
1.4 GHz	0.900	-175.50	7.15	70.66	0.021	-5.78	0.333	-153.29
1.5 GHz	0.900	-177.81	6.69	68.07	0.021	-7.32	0.338	-154.41
1.6 GHz	0.900	-179.98	6.27	65.54	0.021	-8.77	0.344	-155.44
1.7 GHz	0.900	177.96	5.91	63.08	0.020	-10.15	0.349	-156.43
1.8 GHz	0.899	176.00	5.59	60.67	0.020	-11.45	0.355	-157.38
1.9 GHz	0.899	174.12	5.30	58.30	0.020	-12.68	0.361	-158.30
2.0 GHz	0.899	172.31	5.04	55.97	0.020	-13.85	0.366	-159.22
2.1 GHz	0.899	170.54	4.80	53.67	0.020	-14.96	0.372	-160.14
2.2 GHz	0.900	168.83	4.58	51.40	0.020	-16.01	0.378	-161.06
2.3 GHz	0.900	167.15	4.39	49.16	0.019	-17.01	0.384	-161.99
2.4 GHz	0.900	165.49	4.21	46.94	0.019	-17.95	0.390	-162.93
2.5 GHz	0.900	163.87	4.04	44.73	0.019	-18.85	0.396	-163.88
2.6 GHz	0.900	162.26	3.89	42.54	0.019	-19.69	0.402	-164.86
2.7 GHz	0.900	160.66	3.75	40.37	0.019	-20.48	0.407	-165.85
2.8 GHz	0.900	159.08	3.62	38.21	0.019	-21.21	0.413	-166.86
2.9 GHz	0.900	157.51	3.50	36.05	0.018	-21.89	0.418	-167.89
3.0 GHz	0.900	155.93	3.39	33.91	0.018	-22.52	0.424	-168.95
3.2 GHz	0.900	152.79	3.18	29.65	0.018	-23.61	0.435	-171.12
3.4 GHz	0.900	149.64	3.00	25.40	0.017	-24.48	0.445	-173.38
3.6 GHz	0.900	146.45	2.85	21.17	0.017	-25.11	0.454	-175.73
3.8 GHz	0.900	143.23	2.71	16.93	0.017	-25.51	0.463	-178.17
4.0 GHz	0.900	139.94	2.58	12.69	0.017	-25.67	0.471	179.30
4.2 GHz	0.900	136.58	2.47	8.43	0.016	-25.60	0.479	176.67
4.4 GHz	0.899	133.14	2.38	4.15	0.016	-25.32	0.486	173.94
4.6 GHz	0.899	129.61	2.29	-0.17	0.016	-24.85	0.492	171.12
4.8 GHz	0.899	125.97	2.21	-4.53	0.016	-24.24	0.498	168.18
5.0 GHz	0.898	122.23	2.13	-8.94	0.016	-23.54	0.503	165.13
5.2 GHz	0.898	118.36	2.07	-13.41	0.016	-22.80	0.507	161.96
5.4 GHz	0.898	114.36	2.01	-17.95	0.017	-22.11	0.511	158.66
5.6 GHz	0.897	110.22	1.95	-22.56	0.017	-21.54	0.514	155.22
5.8 GHz	0.897	105.94	1.90	-27.26	0.018	-21.16	0.517	151.63
6.0 GHz	0.897	101.51	1.86	-32.04	0.019	-21.04	0.519	147.87

Download this s-parameter file in ".s2p" format at http://www.cree.com/products/wireless_s-parameters.asp

Product Dimensions CGH40010F (Package Type — 440166)

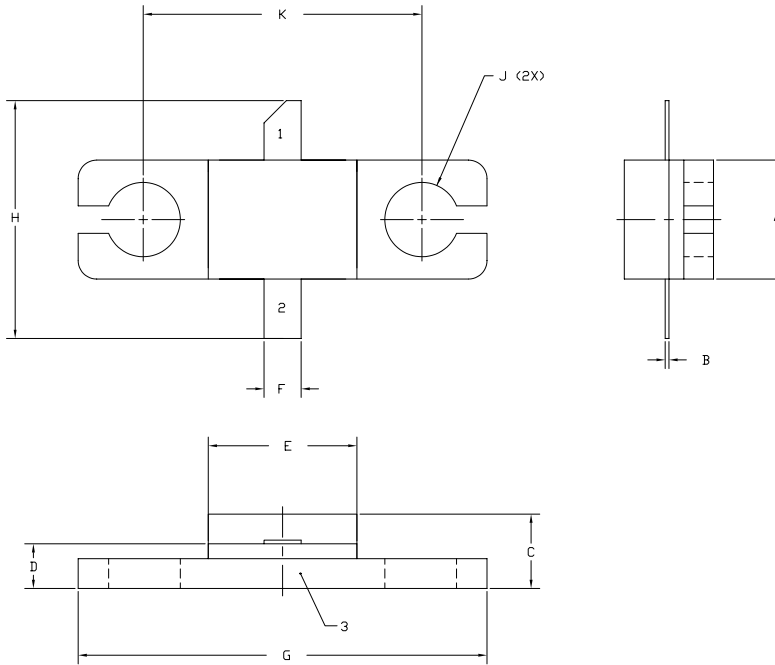

NOTES:

1. DIMENSIONING AND TOLERANCING PER ANSI Y14.5M, 1982.
2. CONTROLLING DIMENSION: INCH.
3. ADHESIVE FROM LID MAY EXTEND A MAXIMUM OF 0.020" BEYOND EDGE OF LID.
4. LID MAY BE MISALIGNED TO THE BODY OF THE PACKAGE BY A MAXIMUM OF 0.008" IN ANY DIRECTION.
5. ALL PLATED SURFACES ARE Ni/AU.

DIM	INCHES		MILLIMETERS	
	MIN	MAX	MIN	MAX
A	0.155	0.165	3.94	4.19
B	0.004	0.006	0.10	0.15
C	0.115	0.135	2.92	3.43
D	0.057	0.067	1.45	1.70
E	0.195	0.205	4.95	5.21
F	0.045	0.055	1.14	1.40
G	0.545	0.555	13.84	14.09
H	0.280	0.360	7.87	8.38
J	Ø .100		2.54	
K	0.375		9.53	

PIN 1. GATE
PIN 2. DRAIN
PIN 3. SOURCE

Product Dimensions CGH40010P (Package Type — 440196)

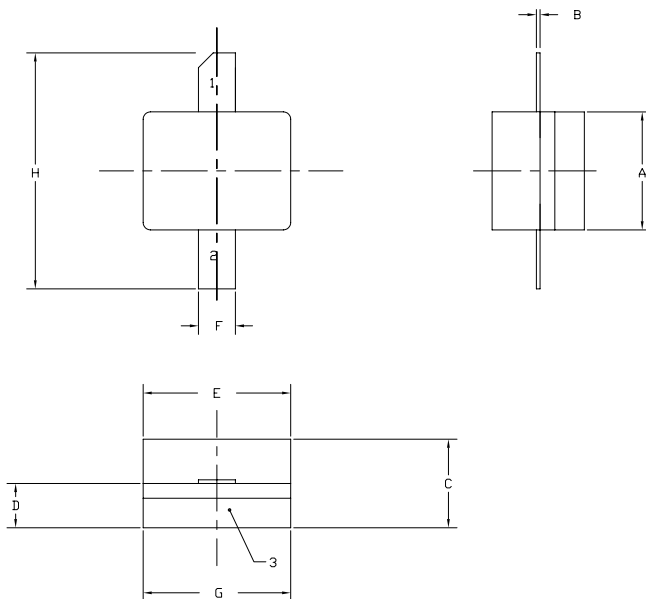

NOTES:

1. DIMENSIONING AND TOLERANCING PER ANSI Y14.5M, 1982.
2. CONTROLLING DIMENSION: INCH.
3. ADHESIVE FROM LID MAY EXTEND A MAXIMUM OF 0.020" BEYOND EDGE OF LID.
4. LID MAY BE MISALIGNED TO THE BODY OF THE PACKAGE BY A MAXIMUM OF 0.008" IN ANY DIRECTION.
5. ALL PLATED SURFACES ARE Ni/AU.

DIM	INCHES		MILLIMETERS	
	MIN	MAX	MIN	MAX
A	0.155	0.165	3.94	4.19
B	0.003	0.006	0.10	0.15
C	0.115	0.135	2.92	3.17
D	0.057	0.067	1.45	1.70
E	0.195	0.205	4.95	5.21
F	0.045	0.055	1.14	1.40
G	0.195	0.205	4.95	5.21
H	0.280	0.360	7.112	9.114

PIN 1. GATE
PIN 2. DRAIN
PIN 3. SOURCE



Disclaimer

Specifications are subject to change without notice. Cree, Inc. believes the information contained within this data sheet to be accurate and reliable. However, no responsibility is assumed by Cree for any infringement of patents or other rights of third parties which may result from its use. No license is granted by implication or otherwise under any patent or patent rights of Cree. Cree makes no warranty, representation or guarantee regarding the suitability of its products for any particular purpose. "Typical" parameters are the average values expected by Cree in large quantities and are provided for information purposes only. These values can and do vary in different applications and actual performance can vary over time. All operating parameters should be validated by customer's technical experts for each application. Cree products are not designed, intended or authorized for use as components in applications intended for surgical implant into the body or to support or sustain life, in applications in which the failure of the Cree product could result in personal injury or death or in applications for planning, construction, maintenance or direct operation of a nuclear facility.

For more information, please contact:

Cree, Inc.
4600 Silicon Drive
Durham, NC 27703
www.cree.com/wireless

Ryan Baker
Marketing
Cree, RF Components
919.407.7816

Tom Dekker
Sales Director
Cree, RF Components
919.407.5639