

IRF5803D2

FETKY™ MOSFET & Schottky Diode

- Co-packaged HEXFET® Power MOSFET and Schottky Diode
- Ideal For Buck Regulator Applications
- P-Channel HEXFET®
- Low V_F Schottky Rectifier
- SO-8 Footprint

Description

The FETKY™ family of Co-packaged HEXFETs and Schottky diodes offer the designer an innovative board space saving solution for switching regulator and power management applications. HEXFETs utilize advanced processing techniques to achieve extremely low on-resistance per silicon area. Combining this technology with International Rectifier's low forward drop Schottky rectifiers results in an extremely efficient device suitable for use in a wide variety of portable electronics applications.

The SO-8 has been modified through a customized leadframe for enhanced thermal characteristics. The SO-8 package is designed for vapor phase, infrared or wave soldering techniques.

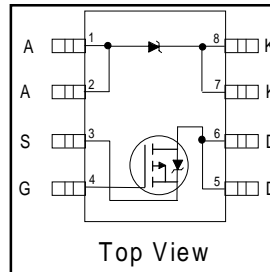

$V_{DSS} = -40V$
$R_{DS(on)} = 112m\Omega$
Schottky $V_f = 0.51V$

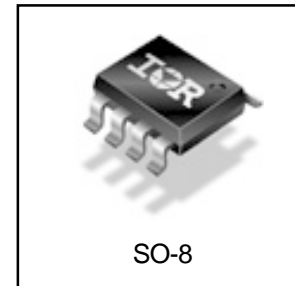

Absolute Maximum Ratings ($T_A = 25^\circ C$ Unless Otherwise Noted)

Parameter	Maximum	Units
$I_D @ T_A = 25^\circ C$	-3.4	A
$I_D @ T_A = 70^\circ C$	-2.7	
I_{DM}	-27	
$P_D @ T_A = 25^\circ C$	2.0	W
$P_D @ T_A = 70^\circ C$	1.3	
	16	mW/°C
V_{GS}	± 20	V
T_J, T_{STG}	-55 to +150	°C

Thermal Resistance

Symbol	Parameter	Typ.	Max.	Units
$R_{\theta JL}$	Junction-to-Drain Lead, MOSFET	—	20	°C/W
$R_{\theta JA}$	Junction-to-Ambient ③, MOSFET	—	62.5	
$R_{\theta JA}$	Junction-to-Ambient ③, SCHOTTKY	—	62.5	

Notes:

- ① Repetitive rating – pulse width limited by max. junction temperature (see fig. 11)
- ② Pulse width $\leq 400\mu s$ – duty cycle $\leq 2\%$
- ③ Surface mounted on 1 inch square copper board, $t \leq 10sec.$

IRF5803D2

Electrical Characteristics @ T_J = 25°C (unless otherwise specified)

International
IR Rectifier

	Parameter	Min.	Typ.	Max.	Units	Conditions
V _{(BR)DSS}	Drain-to-Source Breakdown Voltage	-40	—	—	V	V _{GS} = 0V, I _D = -250μA
ΔV _{(BR)DSS} /ΔT _J	Breakdown Voltage Temp. Coefficient	—	-0.03	—	V/°C	Reference to 25°C, I _D = -1mA
R _{DS(on)}	Static Drain-to-Source On-Resistance	—	—	112	mΩ	V _{GS} = -10V, I _D = -3.4A ②
		—	—	190		V _{GS} = -4.5V, I _D = -2.7A ②
V _{GS(th)}	Gate Threshold Voltage	-1.0	—	-3.0	V	V _{DS} = V _{GS} , I _D = -250μA
g _{fs}	Forward Transconductance	4.0	—	—	S	V _{DS} = -10V, I _D = -3.4A
I _{DSS}	Drain-to-Source Leakage Current	—	—	-10	μA	V _{DS} = -32V, V _{GS} = 0V
		—	—	-25		V _{DS} = -32V, V _{GS} = 0V, T _J = 70°C
I _{GSS}	Gate-to-Source Forward Leakage	—	—	-100	nA	V _{GS} = -20V
	Gate-to-Source Reverse Leakage	—	—	100		V _{GS} = 20V
Q _g	Total Gate Charge	—	25	37	nC	I _D = -3.4A
Q _{gs}	Gate-to-Source Charge	—	4.5	6.8		V _{DS} = -20V
Q _{gd}	Gate-to-Drain ("Miller") Charge	—	3.5	5.3		V _{GS} = -10V, See Fig. 6 & 14 ②
t _{d(on)}	Turn-On Delay Time	—	43	65	ns	V _{DD} = -20V
t _r	Rise Time	—	550	825		I _D = -1.0A
t _{d(off)}	Turn-Off Delay Time	—	88	130		R _G = 6.0Ω
t _f	Fall Time	—	50	75		V _{GS} = -10V, ②
C _{iss}	Input Capacitance	—	1110	—		pF
C _{oss}	Output Capacitance	—	93	—	V _{DS} = -25V	
C _{rss}	Reverse Transfer Capacitance	—	73	—	f = 100kHz, See Fig. 5	

MOSFET Source-Drain Ratings and Characteristics

	Parameter	Min.	Typ.	Max.	Units	Conditions
I _S	Continuous Source Current (Body Diode)	—	—	-2.0	A	
I _{SM}	Pulsed Source Current (Body Diode)	—	—	-27		
V _{SD}	Body Diode Forward Voltage	—	—	-1.2	V	T _J = 25°C, I _S = -2.0A, V _{GS} = 0V
t _{rr}	Reverse Recovery Time (Body Diode)	—	27	40	ns	T _J = 25°C, I _F = -2.0A
Q _{rr}	Reverse Recovery Charge	—	34	50	nC	di/dt = 100A/μs ②

Schottky Diode Maximum Ratings

	Parameter	Max.	Units	Conditions
I _{f(av)}	Max. Average Forward Current	3.0	A	50% Duty Cycle. Rectangular Waveform, T _A = 30°C See Fig.21
I _{SM}	Max. peak one cycle Non-repetitive Surge current	340	A	5μs sine or 3μs Rect. pulse
		70		10ms sine or 6ms Rect. pulse
				Following any rated load condition & with V _{rrm} applied

Schottky Diode Electrical Specifications

	Parameter	Max.	Units	Conditions
V _{fm}	Max. Forward Voltage Drop	0.51	V	I _f = 5.0A, T _J = 25°C
		0.63		I _f = 10A, T _J = 25°C
		0.44		I _f = 5.0A, T _J = 125°C
		0.59		I _f = 10A, T _J = 125°C
V _{rrm}	Max. Working Peak Reverse Voltage	40	V	
I _{rm}	Max. Reverse Leakage Current	3.0	mA	V _r = 40V, T _J = 25°C
		37		T _J = 125°C
C _t	Max. Junction Capacitance	405	pF	V _r = 5Vdc (100kHz to 1 MHz) 25°C

Power Mosfet Characteristics

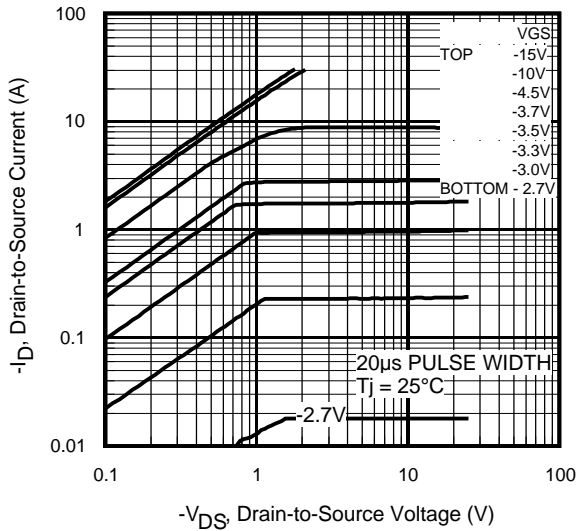

Fig 1. Typical Output Characteristics

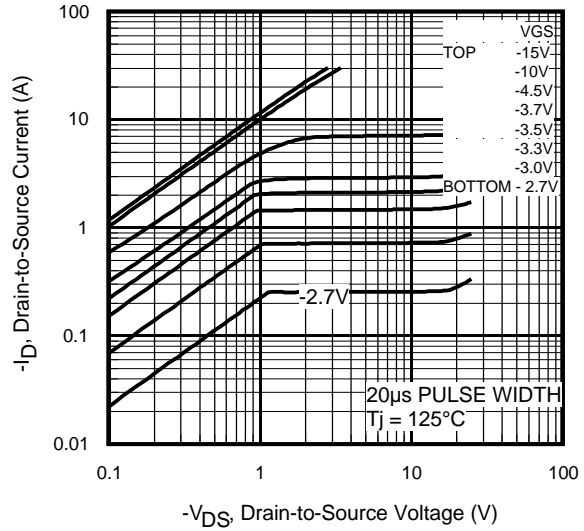

Fig 2. Typical Output Characteristics

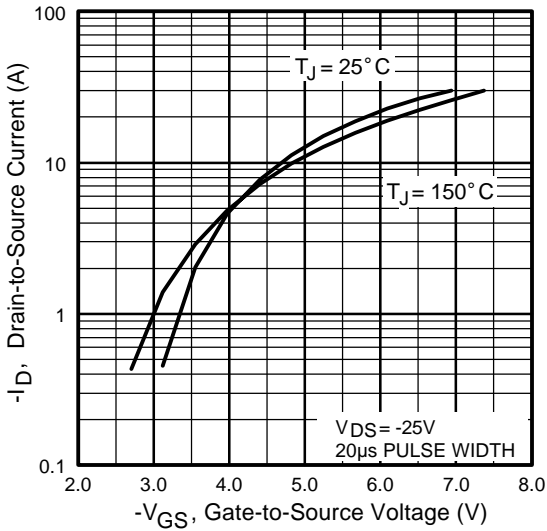

Fig 3. Typical Transfer Characteristics

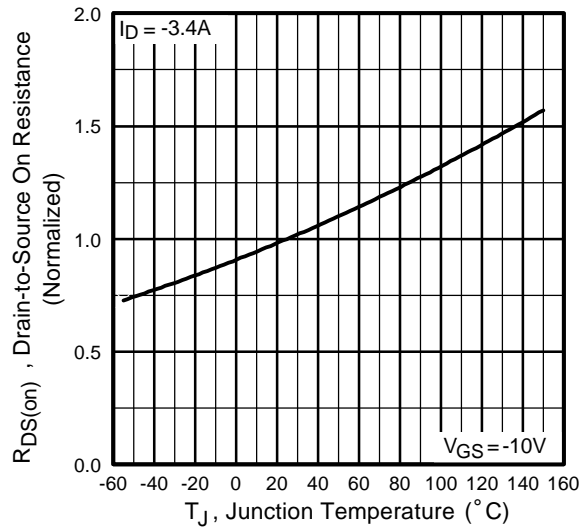

Fig 4. Normalized On-Resistance Vs. Temperature

Power Mosfet Characteristics

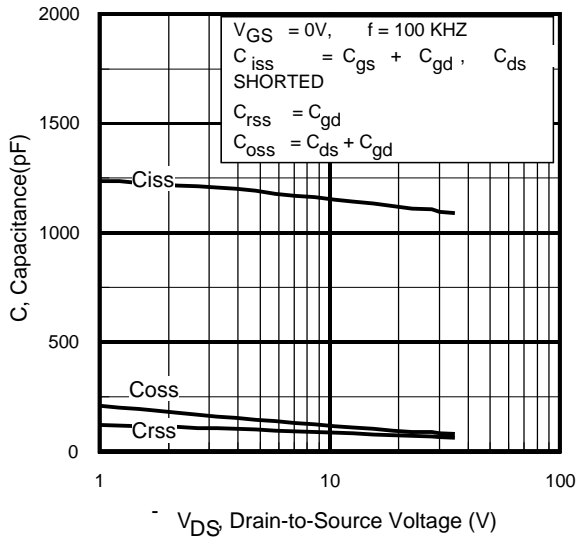

Fig 5. Typical Capacitance Vs. Drain-to-Source Voltage

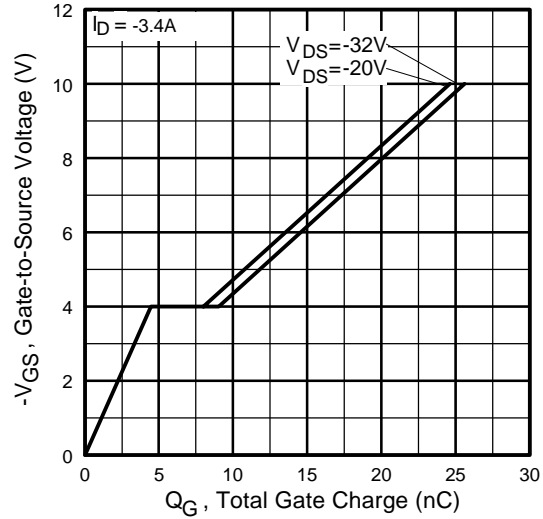

Fig 6. Typical Gate Charge Vs. Gate-to-Source Voltage

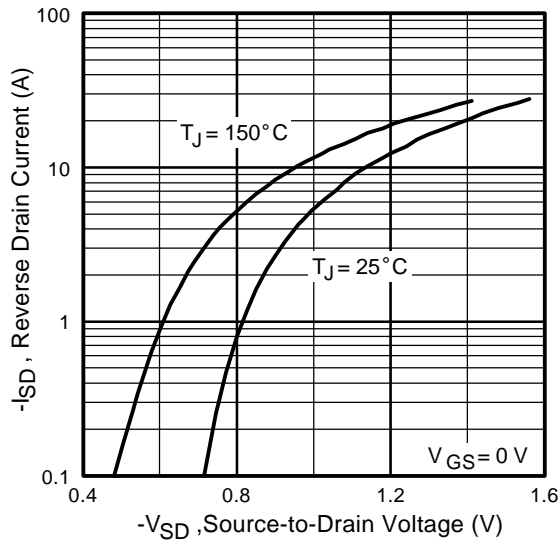

Fig 7. Typical Source-Drain Diode Forward Voltage

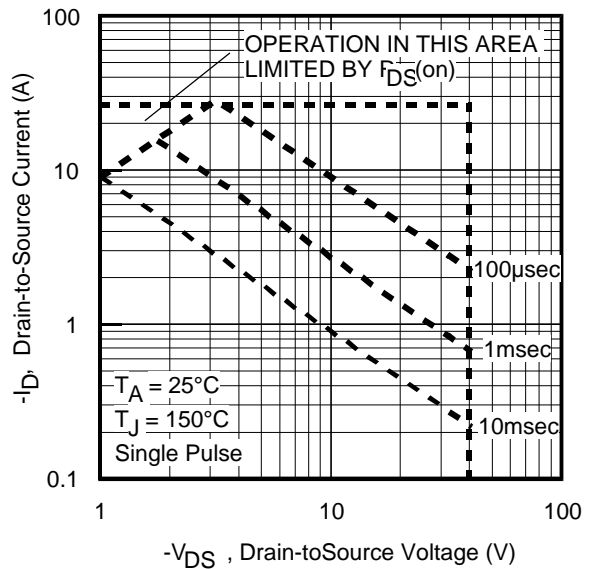

Fig 8. Maximum Safe Operating Area

Power Mosfet Characteristics

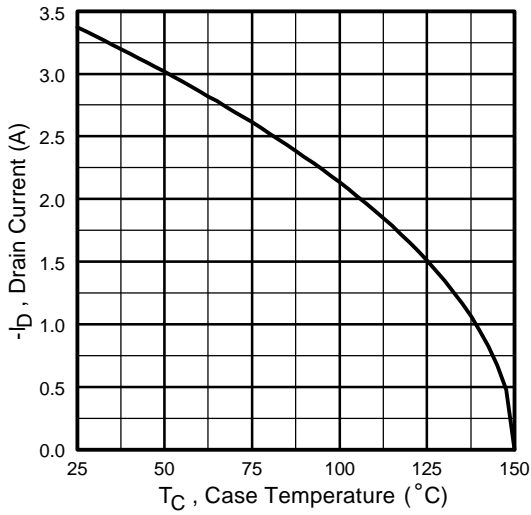

Fig 9. Maximum Drain Current Vs. Case Temperature

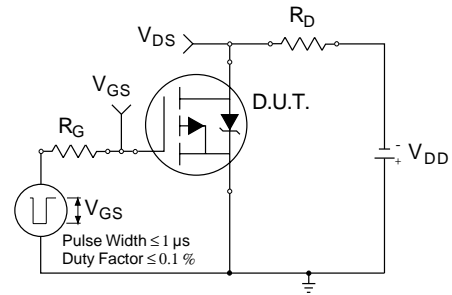

Fig 10a. Switching Time Test Circuit

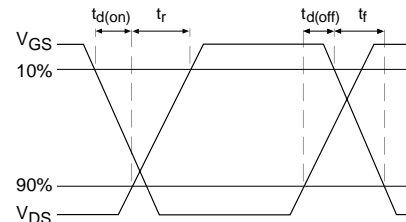

Fig 10b. Switching Time Waveforms

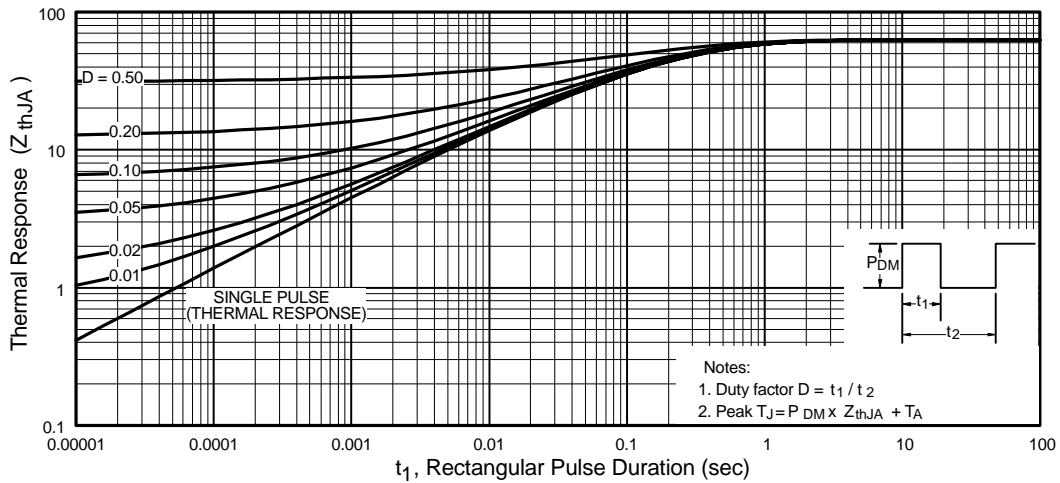

Fig 11. Maximum Effective Transient Thermal Impedance, Junction-to-Ambient

Power Mosfet Characteristics

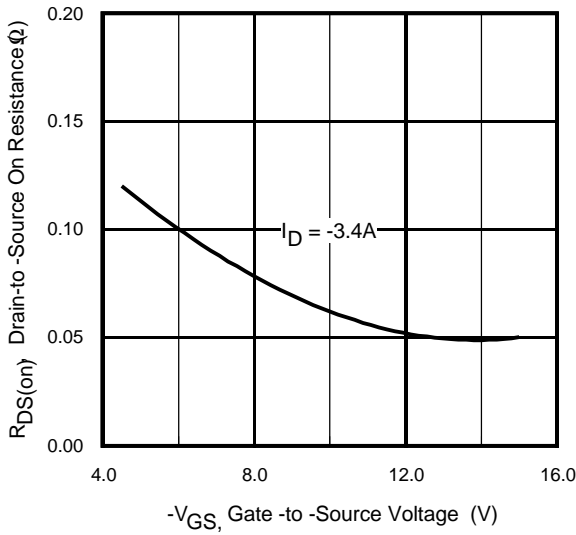

Fig 12. Typical On-Resistance Vs. Gate Voltage

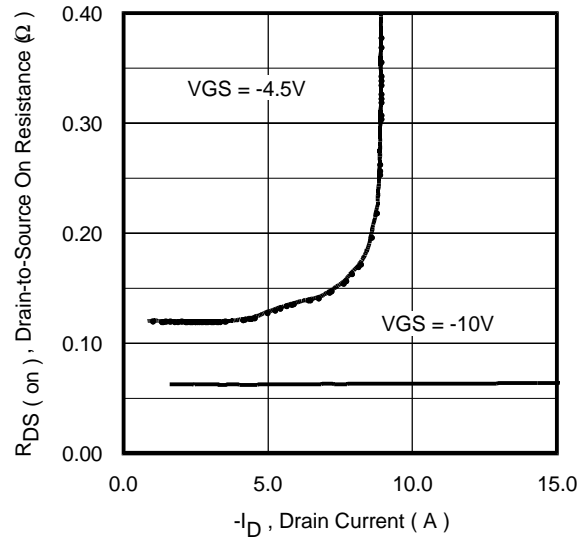

Fig 13. Typical On-Resistance Vs. Drain Current

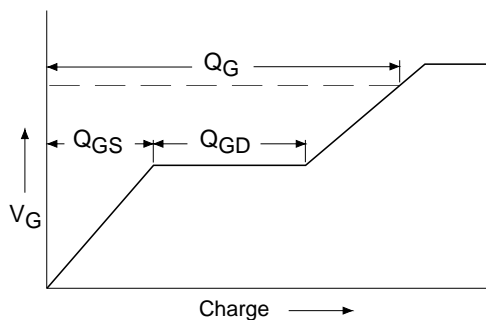

Fig 14a. Basic Gate Charge Waveform

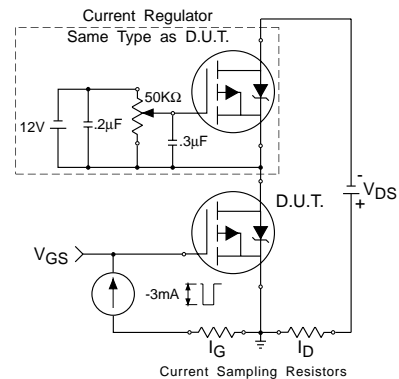

Fig 14b. Gate Charge Test Circuit

Power Mosfet Characteristics

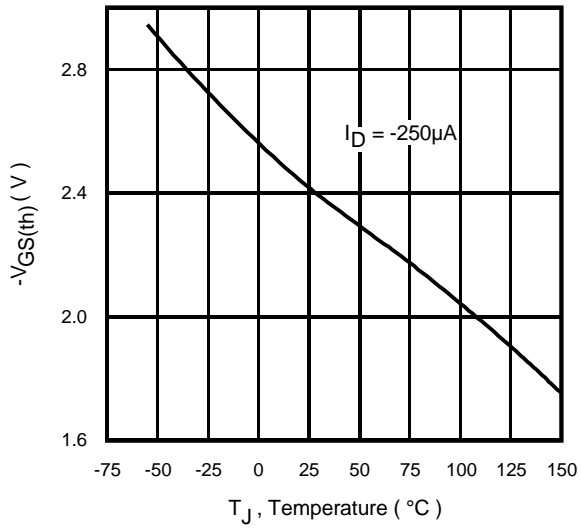

Fig 15. Typical $V_{GS(th)}$ Vs. Junction Temperature

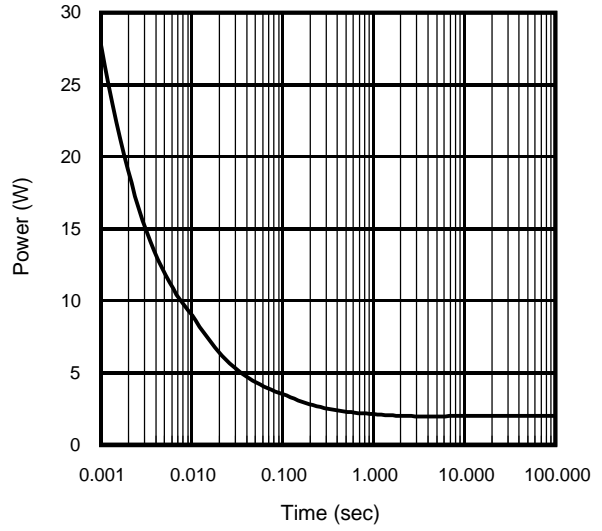

Fig 16. Typical Power Vs. Time

Schottky Diode Characteristics

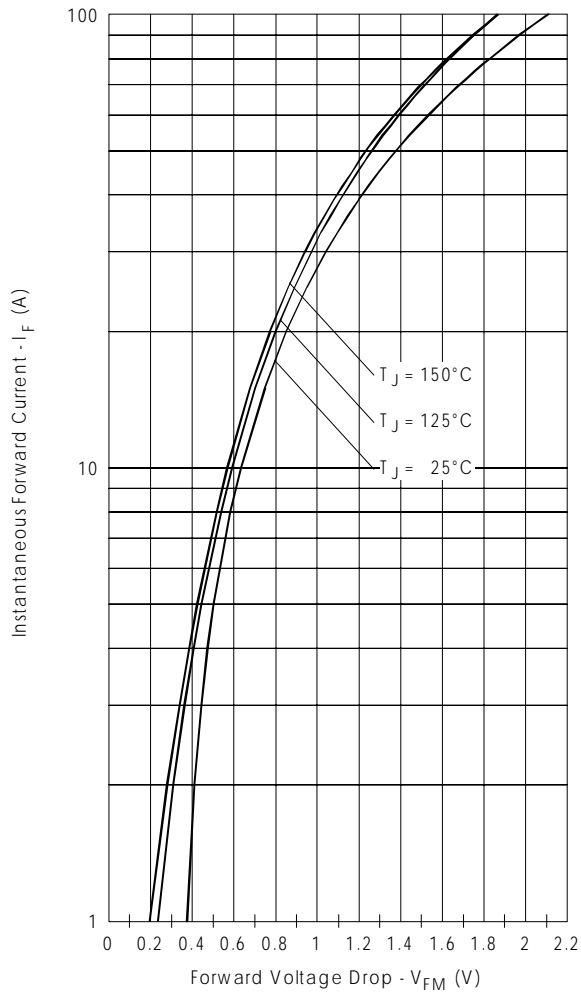

Fig. 17 - Maximum Forward Voltage Drop Characteristics

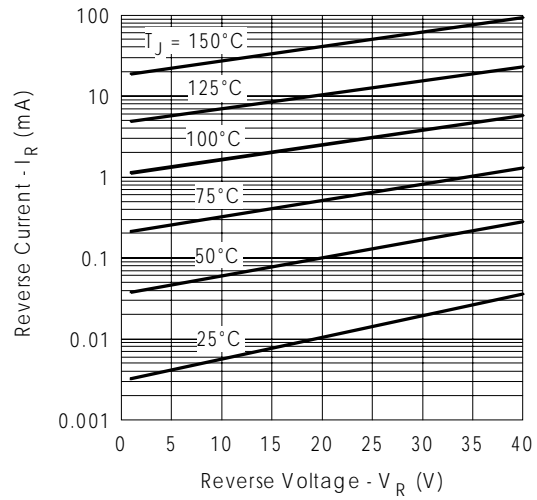

Fig. 18 - Typical Values of Reverse Current Vs. Reverse Voltage

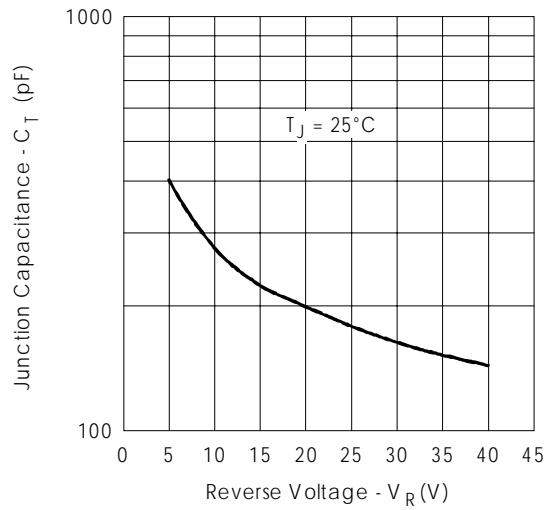

Fig. 19 - Typical Junction Capacitance Vs. Reverse Voltage

Schottky Diode Characteristics

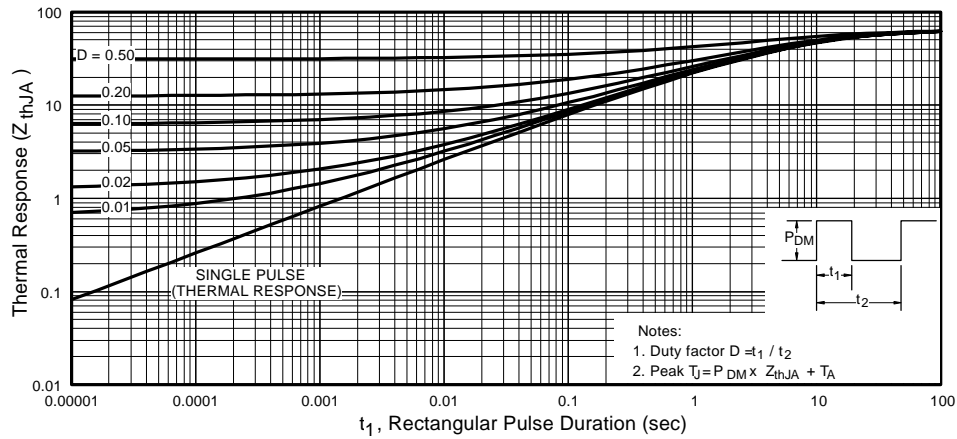

Fig 20. Maximum Effective Transient Thermal Impedance, Junction-to-Ambient

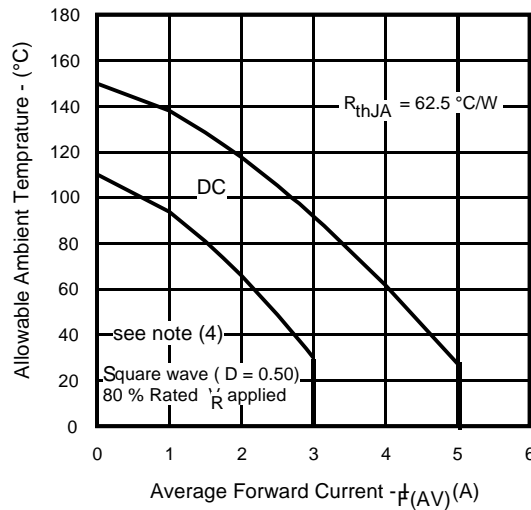
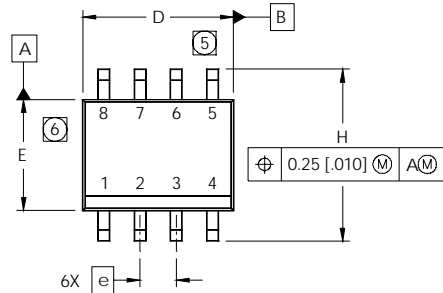

Fig.21 - Maximum Allowable Ambient Temp. Vs. Forward Current

Note (4) Formula used: $T_C = T_J - (Pd + Pd_{REV}) \times R_{thJA}$;
 $Pd = \text{Forward Power Loss} = I_{F(AV)} \times V_{FM} @ (I_{F(AV)} / D)$;
 $Pd_{REV} = \text{Inverse Power Loss} = V_{R1} \times I_R (1 - D)$; $I_R @ V_{R1} = 80\% \text{ rated } V_R$
www.irf.com

IRF5803D2

SO-8 Package Details



DIM	INCHES		MILLIMETERS	
	MIN	MAX	MIN	MAX
A	.0532	.0688	1.35	1.75
A1	.0040	.0098	0.10	0.25
b	.013	.020	0.33	0.51
c	.0075	.0098	0.19	0.25
D	.189	.1968	4.80	5.00
E	.1497	.1574	3.80	4.00
e	.050 BASIC		1.27 BASIC	
e1	.025 BASIC		0.635 BASIC	
H	.2284	.2440	5.80	6.20
K	.0099	.0196	0.25	0.50
L	.016	.050	0.40	1.27
y	0°	8°	0°	8°

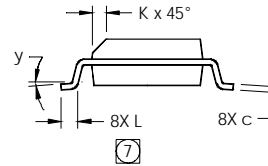
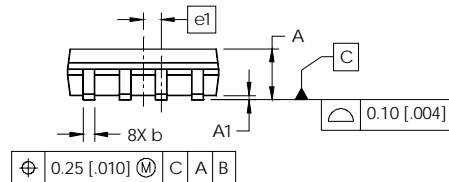

NOTES:

1. DIMENSIONING & TOLERANCING PER ASME Y14.5M-1994.
2. CONTROLLING DIMENSION: MILLIMETER
3. DIMENSIONS ARE SHOWN IN MILLIMETERS [INCHES].
4. OUTLINE CONFORMS TO JEDEC OUTLINE MS-012AA.
- ⑤ DIMENSION DOES NOT INCLUDE MOLD PROTRUSIONS. MOLD PROTRUSIONS NOT TO EXCEED 0.15 [0.006].
- ⑥ DIMENSION DOES NOT INCLUDE MOLD PROTRUSIONS. MOLD PROTRUSIONS NOT TO EXCEED 0.25 [0.010].
- ⑦ DIMENSION IS THE LENGTH OF LEAD FOR SOLDERING TO A SUBSTRATE.

FOOTPRINT

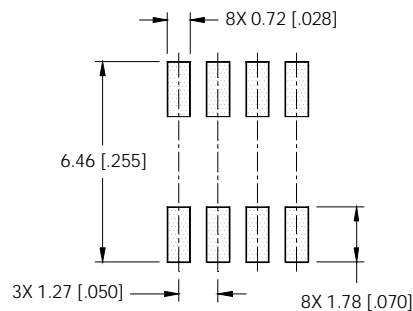

SO-8 Part Marking

EXAMPLE: THIS IS AN IRF7101 (MOSFET)

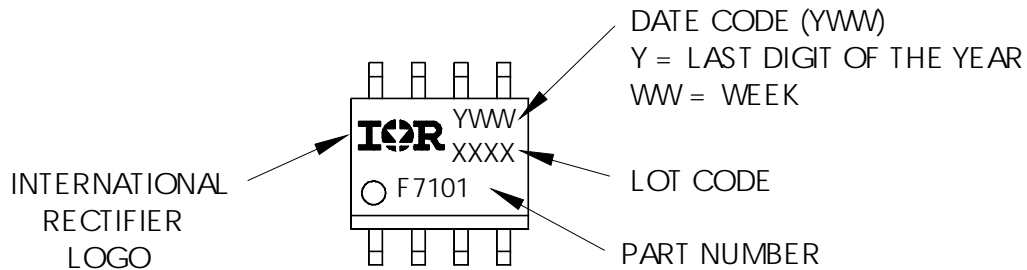

SO-8 Tape and Reel

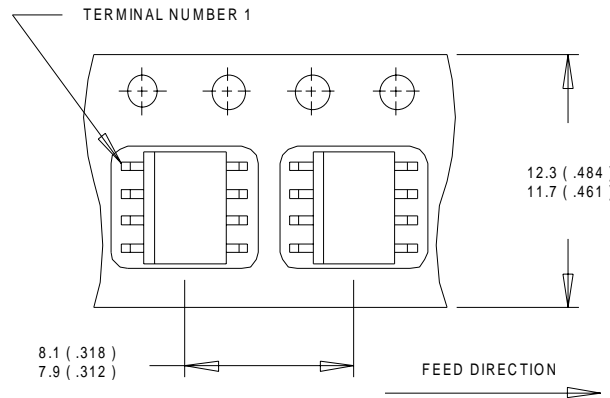

- NOTES:
1. CONTROLLING DIMENSION : MILLIMETER.
 2. ALL DIMENSIONS ARE SHOWN IN MILLIMETERS(INCHES).
 3. OUTLINE CONFORMS TO EIA-481 & EIA-541.

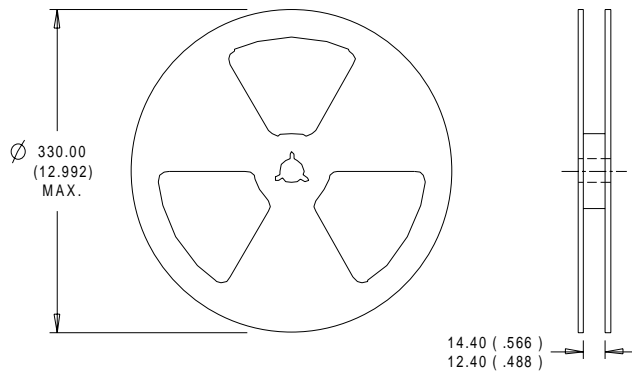

- NOTES :
1. CONTROLLING DIMENSION : MILLIMETER.
 2. OUTLINE CONFORMS TO EIA-481 & EIA-541.

Data and specifications subject to change without notice.
 This product has been designed and qualified for the consumer market.
 Qualification Standards can be found on IR's Web site.

International
IR Rectifier

IR WORLD HEADQUARTERS: 233 Kansas St., El Segundo, California 90245, USA Tel: (310) 252-7105
 TAC Fax: (310) 252-7903

Visit us at www.irf.com for sales contact information.03/01