

IRF6100

HEXFET[®] Power MOSFET

- Ultra Low $R_{DS(on)}$ per Footprint Area
- Low Thermal Resistance
- P-Channel MOSFET
- One-third Footprint of SOT-23
- Super Low Profile (<.8mm)
- Available Tested on Tape & Reel

V_{DSS}	$R_{DS(on)}$ max	I_D
-20V	0.065 Ω @ $V_{GS} = -4.5V$	-5.1A
	0.095 Ω @ $V_{GS} = -2.5V$	-4.1A

Description

True chip-scale packaging is available from International Rectifier. Through the use of advanced processing techniques, and a unique packaging concept, extremely low on-resistance and the highest power densities in the industry have been made available for battery and load management applications. These benefits, combined with the ruggedized device design, that International Rectifier is well known for, provides the designer with an extremely efficient and reliable device.

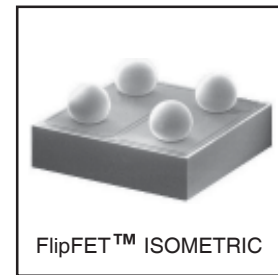
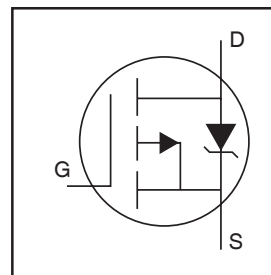

The FlipFET[™] package, is one-third the footprint of a comparable SOT-23 package and has a profile of less than .8mm. Combined with the low thermal resistance of the die level device, this makes the FlipFET[™] the best device for application where printed circuit board space is at a premium and in extremely thin application environments such as battery packs, cell phones and PCMCIA cards.

Absolute Maximum Ratings

	Parameter	Max.	Units
V_{DS}	Drain- Source Voltage	-20	V
I_D @ $T_A = 25^\circ C$	Continuous Drain Current, V_{GS} @ 4.5V	± 5.1	A
I_D @ $T_A = 70^\circ C$	Continuous Drain Current, V_{GS} @ 4.5V	± 3.5	
I_{DM}	Pulsed Drain Current ①	± 35	
P_D @ $T_A = 25^\circ C$	Power Dissipation ③	2.2	W
P_D @ $T_A = 70^\circ C$	Power Dissipation ③	1.4	
	Linear Derating Factor	17	mW/ $^\circ C$
V_{GS}	Gate-to-Source Voltage	± 12	V
T_J, T_{STG}	Junction and Storage Temperature Range	-55 to + 150	$^\circ C$

Thermal Resistance

Symbol	Parameter	Typ.	Max.	Units
$R_{\theta JA}$	Junction-to-Ambient ③		56.5	$^\circ C/W$
$R_{\theta J-PCB}$	Junction-to-PCB mounted	35	—	

www.irf.com

1

07/13/06

Electrical Characteristics @ $T_J = 25^\circ\text{C}$ (unless otherwise specified)

	Parameter	Min.	Typ.	Max.	Units	Conditions
$V_{(BR)DSS}$	Drain-to-Source Breakdown Voltage	-20	—	—	V	$V_{GS} = 0V, I_D = -250\mu A$
$\Delta V_{(BR)DSS}/\Delta T_J$	Breakdown Voltage Temp. Coefficient	—	-0.010	—	V/°C	Reference to 25°C , $I_D = -1\text{mA}$
$R_{DS(on)}$	Static Drain-to-Source On-Resistance	—	—	0.065	Ω	$V_{GS} = -4.5V, I_D = -5.1A$ ②
		—	—	0.095		$V_{GS} = -2.5V, I_D = -4.1A$ ②
$V_{GS(th)}$	Gate Threshold Voltage	-0.45	—	-1.2	V	$V_{DS} = V_{GS}, I_D = -250\mu A$
g_{fs}	Forward Transconductance	9.8	—	—	S	$V_{DS} = -10V, I_D = -5.1A$
I_{DSS}	Drain-to-Source Leakage Current	—	—	-1.0	μA	$V_{DS} = -20V, V_{GS} = 0V$
		—	—	-25		$V_{DS} = -16V, V_{GS} = 0V, T_J = 125^\circ\text{C}$
I_{GSS}	Gate-to-Source Forward Leakage	—	—	100	nA	$V_{GS} = 12V$
	Gate-to-Source Reverse Leakage	—	—	-100		$V_{GS} = -12V$
Q_g	Total Gate Charge	—	14	21	nC	$I_D = -5.1A$
Q_{gs}	Gate-to-Source Charge	—	1.9	2.9		$V_{DS} = -16V$
Q_{gd}	Gate-to-Drain ("Miller") Charge	—	5.0	7.5		$V_{GS} = -5.0V$
$t_{d(on)}$	Turn-On Delay Time	—	12	—	ns	$V_{DD} = -10V$
t_r	Rise Time	—	12	—		$I_D = -1.0A$
$t_{d(off)}$	Turn-Off Delay Time	—	50	—		$R_G = 5.8\Omega$
t_f	Fall Time	—	50	—		$V_{GS} = -4.5V$ ②
C_{iss}	Input Capacitance	—	1230	—	pF	$V_{GS} = 0V$
C_{oss}	Output Capacitance	—	250	—		$V_{DS} = -15V$
C_{rss}	Reverse Transfer Capacitance	—	180	—		$f = 1.0\text{MHz}$, See Fig. 5

Source-Drain Ratings and Characteristics

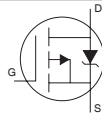
	Parameter	Min.	Typ.	Max.	Units	Conditions
I_S	Continuous Source Current (Body Diode)	—	—	-2.2	A	MOSFET symbol showing the integral reverse p-n junction diode. 
I_{SM}	Pulsed Source Current (Body Diode) ①	—	—	-33		
V_{SD}	Diode Forward Voltage	—	—	-1.2	V	$T_J = 25^\circ\text{C}, I_S = -2.2A, V_{GS} = 0V$ ②
t_{rr}	Reverse Recovery Time	—	48	72	ns	$T_J = 25^\circ\text{C}, I_F = -2.2A$
Q_{rr}	Reverse Recovery Charge	—	34	51	nC	$di/dt = 100A/\mu s$ ②

Notes:

- ① Repetitive rating; pulse width limited by max. junction temperature. ③ When mounted on 1 inch square 2oz copper on FR-4.
- ② Pulse width $\leq 400\mu s$; duty cycle $\leq 2\%$.

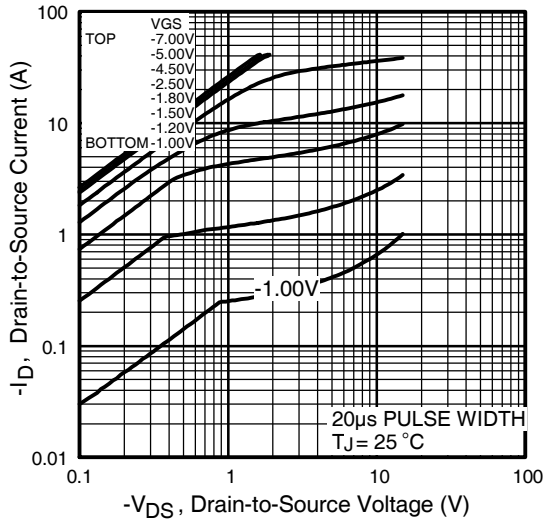

Fig 1. Typical Output Characteristics

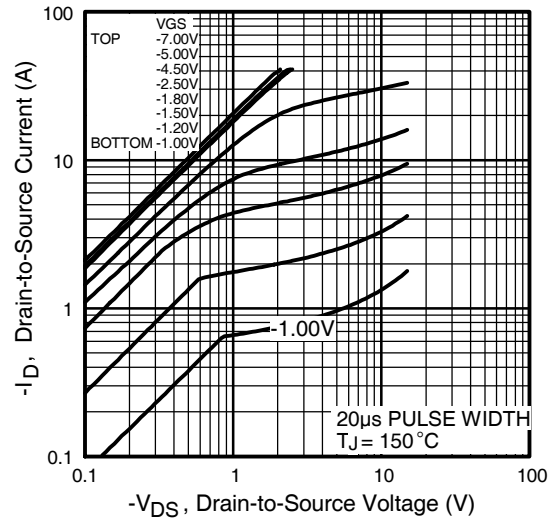

Fig 2. Typical Output Characteristics

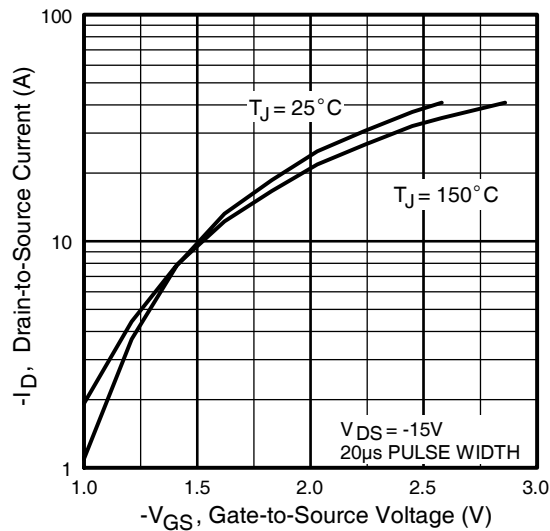

Fig 3. Typical Transfer Characteristics

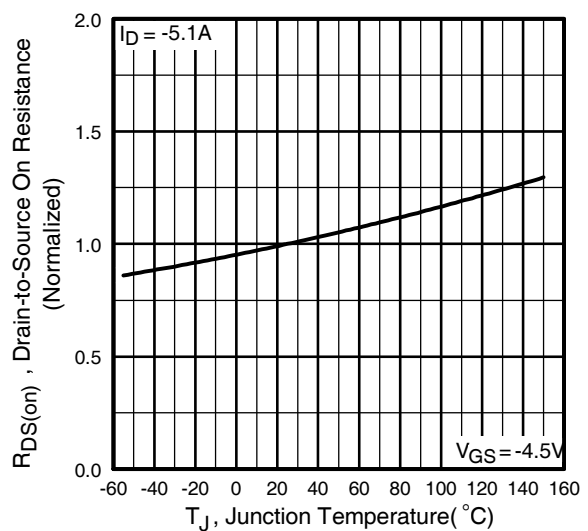

Fig 4. Normalized On-Resistance Vs. Temperature

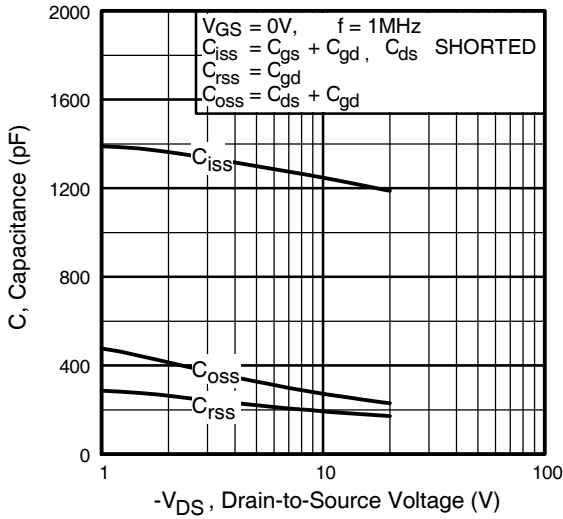

Fig 5. Typical Capacitance Vs. Drain-to-Source Voltage

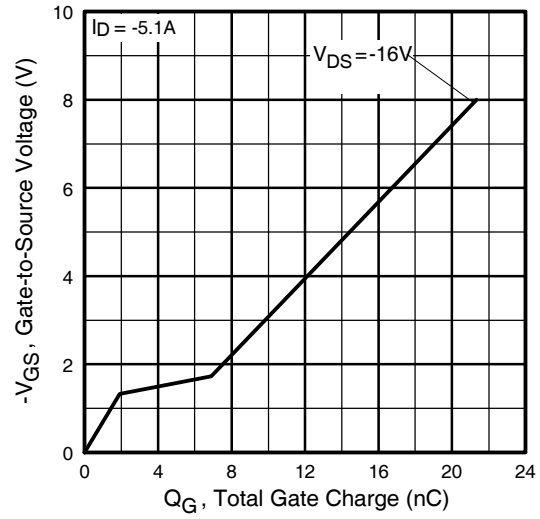

Fig 6. Typical Gate Charge Vs. Gate-to-Source Voltage

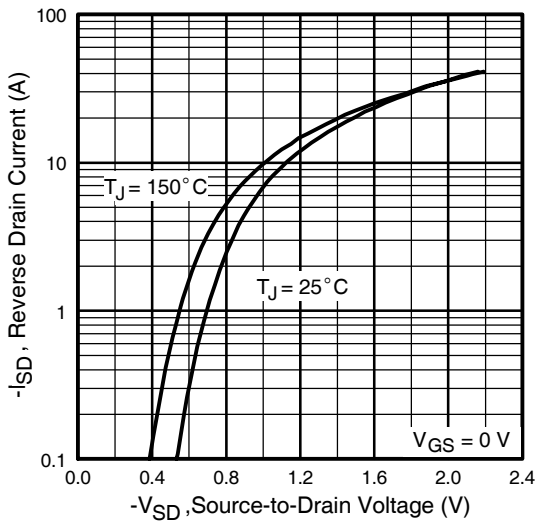

Fig 7. Typical Source-Drain Diode Forward Voltage

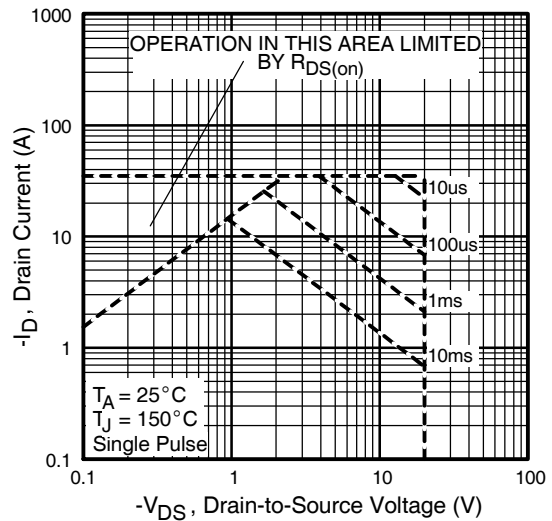

Fig 8. Maximum Safe Operating Area

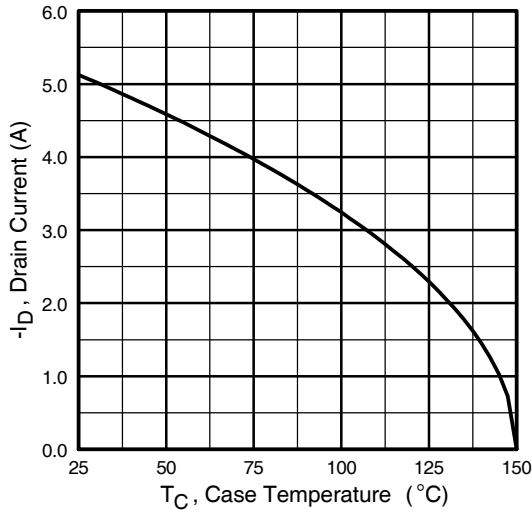

Fig 9. Maximum Drain Current Vs. Case Temperature

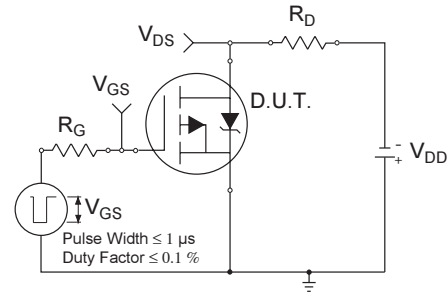

Fig 10a. Switching Time Test Circuit

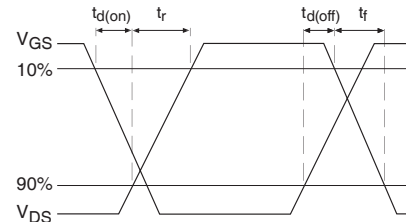

Fig 10b. Switching Time Waveforms

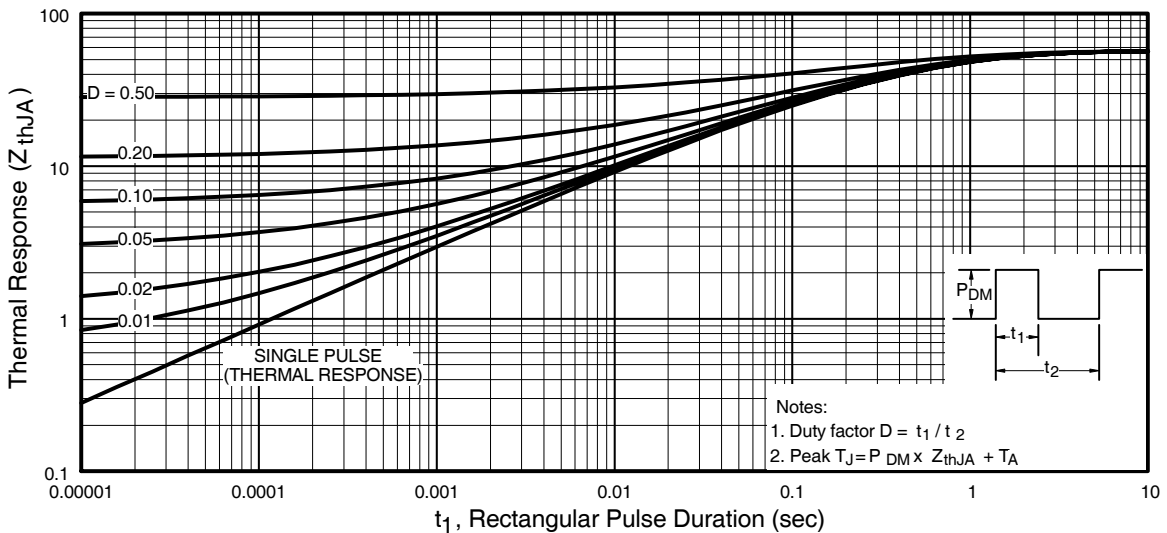

Fig 11. Maximum Effective Transient Thermal Impedance, Junction-to-Ambient

IRF6100

International
IR Rectifier

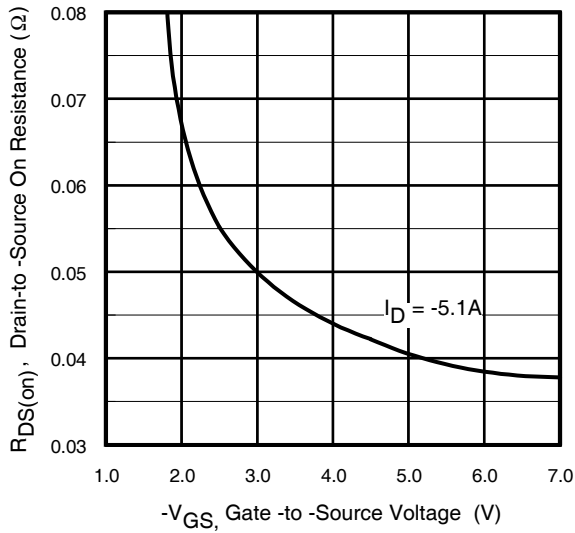

Fig 12. Typical On-Resistance Vs. Gate Voltage

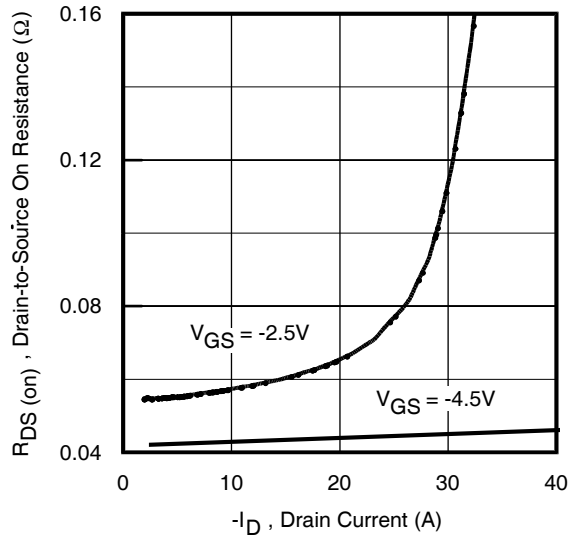

Fig 13. Typical On-Resistance Vs. Drain Current

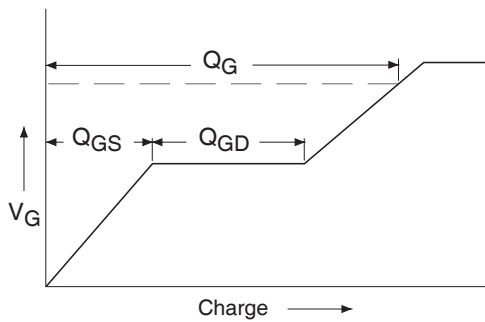

Fig 14a. Basic Gate Charge Waveform

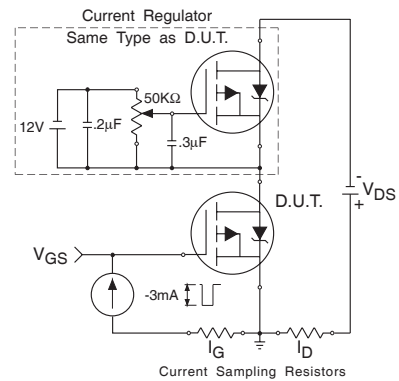

Fig 14b. Gate Charge Test Circuit

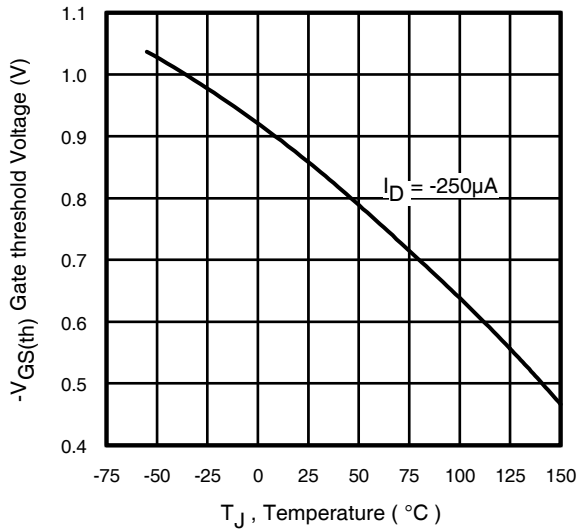

Fig 15. Threshold Voltage Vs. Temperature

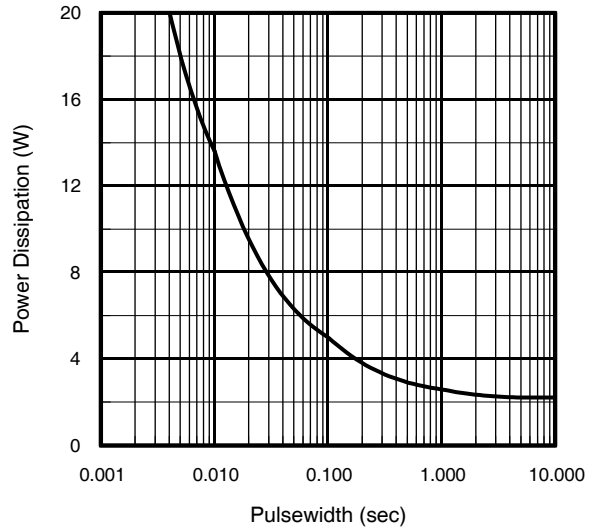
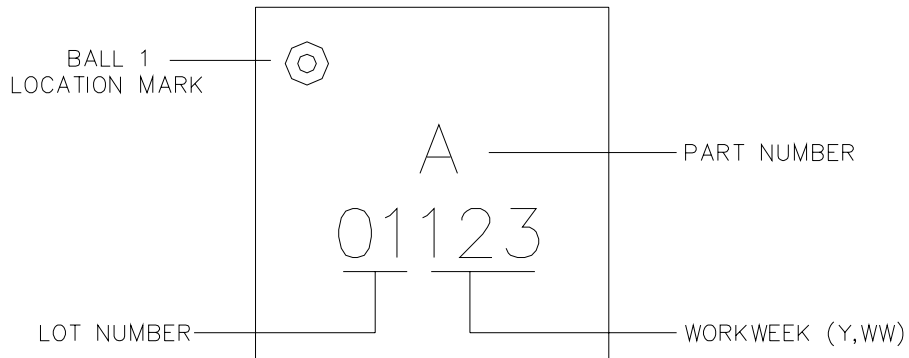

Fig 16. Maximum Power Dissipation Vs. Time

FlipFET™ Part Marking Information



IRF6100

International
IR Rectifier

FlipFET™ Outline Dimension and Tape and Reel

NOTES:
1. DIMENSIONING & TOLERANCING PER ASME Y14.5M-1994.
2. CONTROLLING DIMENSION: MILLIMETER
3. DIMENSIONS ARE SHOWN IN MILLIMETERS [INCHES].

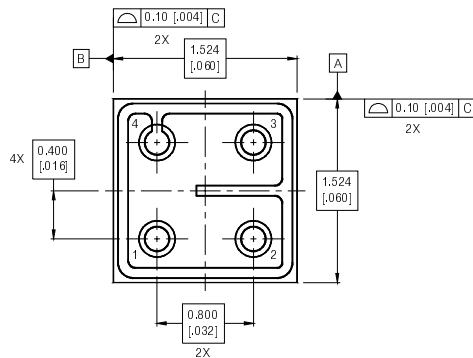

BOTTOM VIEW

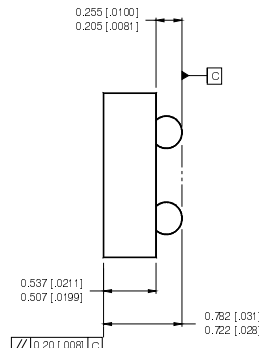

SIDE VIEW

BALL ASSIGNMENTS

- 1 = SOURCE
- 2 = DRAIN
- 3 = DRAIN
- 4 = GATE

LEADFREE SOLDER BALL COMPOSITION

- 95.9% Sn
- 3.5% Ag
- 0.7% Cu

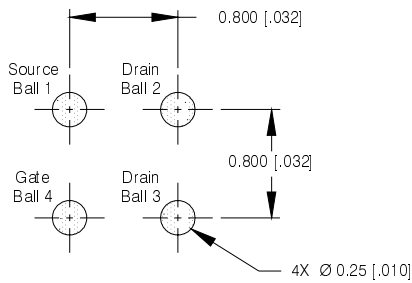

RECOMMENDED FOOTPRINT

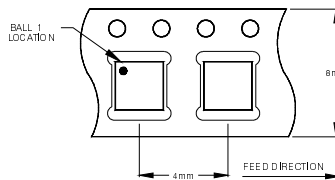
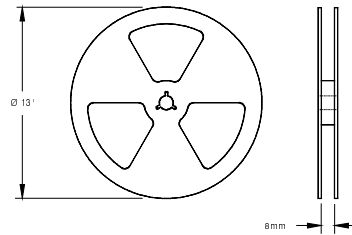

NOTES:
1. TAPE AND REEL OUTLINE CONFORMS TO EIA-481 & EIA-541.

Tape and Reel

Data and specifications subject to change without notice.
This product has been designed and qualified for the Consumer market.
Qualification Standards can be found on IR's Web site.

International
IR Rectifier

IR WORLD HEADQUARTERS: 233 Kansas St., El Segundo, California 90245, USA Tel: (310) 252-7105
TAC Fax: (310) 252-7903

Visit us at www.irf.com for sales contact information.07/06

www.irf.com