

PRELIMINARY

# IRF7521D1

FETKY™ MOSFET / Schottky Diode

- Co-packaged HEXFET® Power MOSFET and Schottky Diode
- N-Channel HEXFET
- Low  $V_F$  Schottky Rectifier
- Generation 5 Technology
- Micro8™ Footprint

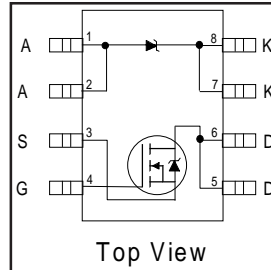

$V_{DSS} = 20V$
$R_{DS(on)} = 0.135\Omega$
Schottky $V_f = 0.39V$

## Description

The FETKY™ family of co-packaged HEXFETs and Schottky diodes offer the designer an innovative board space saving solution for switching regulator applications. Generation 5 HEXFETs utilize advanced processing techniques to achieve extremely low on-resistance per silicon area. Combining this technology with International Rectifier's low forward drop Schottky rectifiers results in an extremely efficient device suitable for use in a wide variety of portable electronics applications like cell phone, PDA, etc.

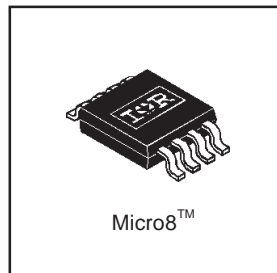

The new Micro8™ package, with half the footprint area of the standard SO-8, provides the smallest footprint available in an SOIC outline. This makes the Micro8™ an ideal device for applications where printed circuit board space is at a premium. The low profile (<1.1mm) of the Micro8™ will allow it to fit easily into extremely thin application environments such as portable electronics and PCMCIA cards.

## Absolute Maximum Ratings ( $T_A = 25^\circ C$ unless otherwise noted)

Parameter		Maximum	Units
$I_D @ T_A = 25^\circ C$	Continuous Drain Current, $V_{GS} @ 4.5V$	2.4	A
$I_D @ T_A = 70^\circ C$		1.9	
$I_{DM}$	Pulsed Drain Current ①	19	
$P_D @ T_A = 25^\circ C$	Power Dissipation	1.3	W
$P_D @ T_A = 70^\circ C$		0.8	
	Linear Derating Factor	10	mW/°C
$V_{GS}$	Gate-to-Source Voltage	$\pm 12$	V
dv/dt	Peak Diode Recovery dv/dt ②	5.0	V/ns
$T_J, T_{STG}$	Junction and Storage Temperature Range	-55 to +150	°C

## Thermal Resistance Ratings

Parameter		Maximum	Units
$R_{\theta JA}$	Junction-to-Ambient ④	100	°C/W

### Notes:

- ① Repetitive rating; pulse width limited by maximum junction temperature (see figure 9)
- ②  $I_{SD} \leq 1.7A$ ,  $di/dt \leq 66A/\mu s$ ,  $V_{DD} \leq V_{(BR)DSS}$ ,  $T_J \leq 150^\circ C$
- ③ Pulse width  $\leq 300\mu s$ ; duty cycle  $\leq 2\%$
- ④ Surface mounted on FR-4 board,  $t \leq 10sec$ .

**MOSFET Electrical Characteristics @ T<sub>J</sub> = 25°C (unless otherwise specified)**

	Parameter	Min.	Typ.	Max.	Units	Conditions
V <sub>(BR)DSS</sub>	Drain-to-Source Breakdown Voltage	20	—	—	V	V <sub>GS</sub> = 0V, I <sub>D</sub> = 250μA
R <sub>DS(on)</sub>	Static Drain-to-Source On-Resistance	—	0.085	0.135	Ω	V <sub>GS</sub> = 4.5V, I <sub>D</sub> = 1.7A ③
		—	0.12	0.20		V <sub>GS</sub> = 2.7V, I <sub>D</sub> = 0.85A ③
V <sub>GS(th)</sub>	Gate Threshold Voltage	0.70	—	—	V	V <sub>DS</sub> = V <sub>GS</sub> , I <sub>D</sub> = 250μA
g <sub>fs</sub>	Forward Transconductance	2.6	—	—	S	V <sub>DS</sub> = 10V, I <sub>D</sub> = 0.85A
I <sub>DSS</sub>	Drain-to-Source Leakage Current	—	—	1.0	μA	V <sub>DS</sub> = 16V, V <sub>GS</sub> = 0V
		—	—	25		V <sub>DS</sub> = 16V, V <sub>GS</sub> = 0V, T <sub>J</sub> = 125°C
I <sub>GSS</sub>	Gate-to-Source Forward Leakage	—	—	100	nA	V <sub>GS</sub> = 12V
	Gate-to-Source Reverse Leakage	—	—	-100		V <sub>GS</sub> = -12V
Q <sub>g</sub>	Total Gate Charge	—	5.3	8.0	nC	I <sub>D</sub> = 1.7A
Q <sub>gs</sub>	Gate-to-Source Charge	—	0.84	1.3		V <sub>DS</sub> = 16V
Q <sub>gd</sub>	Gate-to-Drain ("Miller") Charge	—	2.2	3.3		V <sub>GS</sub> = 4.5V, See Fig. 6 ③
t <sub>d(on)</sub>	Turn-On Delay Time	—	5.7	—		V <sub>DD</sub> = 10V
t <sub>r</sub>	Rise Time	—	24	—	ns	I <sub>D</sub> = 1.7A
t <sub>d(off)</sub>	Turn-Off Delay Time	—	15	—		R <sub>G</sub> = 6.0Ω
t <sub>f</sub>	Fall Time	—	16	—		R <sub>D</sub> = 5.7Ω, ③
C <sub>iss</sub>	Input Capacitance	—	260	—		V <sub>GS</sub> = 0V
C <sub>oss</sub>	Output Capacitance	—	130	—	pF	V <sub>DS</sub> = 15V
C <sub>rss</sub>	Reverse Transfer Capacitance	—	61	—		f = 1.0MHz, See Fig. 5

**MOSFET Source-Drain Ratings and Characteristics**

	Parameter	Min.	Typ.	Max.	Units	Conditions
I <sub>S</sub>	Continuous Source Current(Body Diode)	—	—	1.3	A	
I <sub>SM</sub>	Pulsed Source Current (Body Diode)	—	—	14		
V <sub>SD</sub>	Body Diode Forward Voltage	—	—	1.2	V	T <sub>J</sub> = 25°C, I <sub>S</sub> = 1.7A, V <sub>GS</sub> = 0V
t <sub>rr</sub>	Reverse Recovery Time (Body Diode)	—	39	59	ns	T <sub>J</sub> = 25°C, I <sub>F</sub> = 1.7A
Q <sub>rr</sub>	Reverse Recovery Charge	—	37	56	nC	di/dt = 100A/μs ③

**Schottky Diode Maximum Ratings**

	Parameter	Max.	Units	Conditions
I <sub>F(av)</sub>	Max. Average Forward Current	1.9	A	50% Duty Cycle. Rectangular Wave, T <sub>A</sub> = 25°C See Fig.14 T <sub>A</sub> = 70°C
		1.4		
I <sub>SM</sub>	Max. peak one cycle Non-repetitive Surge current	120	A	Following any rated load condition & with V <sub>RRM</sub> applied
		11		

**Schottky Diode Electrical Specifications**

	Parameter	Max.	Units	Conditions
V <sub>FM</sub>	Max. Forward voltage drop	0.50	V	I <sub>F</sub> = 1.0A, T <sub>J</sub> = 25°C
		0.62		I <sub>F</sub> = 2.0A, T <sub>J</sub> = 25°C
		0.39		I <sub>F</sub> = 1.0A, T <sub>J</sub> = 125°C
		0.57		I <sub>F</sub> = 2.0A, T <sub>J</sub> = 125°C .
I <sub>RM</sub>	Max. Reverse Leakage current	0.02	mA	V <sub>R</sub> = 20V, T <sub>J</sub> = 25°C
		8		T <sub>J</sub> = 125°C
C <sub>t</sub>	Max. Junction Capacitance	92	pF	V <sub>R</sub> = 5Vdc ( 100kHz to 1 MHz) 25°C
dv/dt	Max. Voltage Rate of Charge	3600	V/ μs	Rated V <sub>R</sub>

(HEXFET is the reg. TM for International Rectifier Power MOSFET's )

Power Mosfet Characteristics

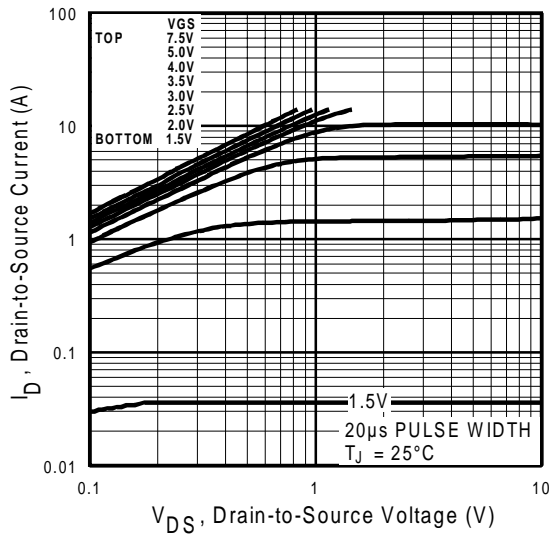

Fig 1. Typical Output Characteristics

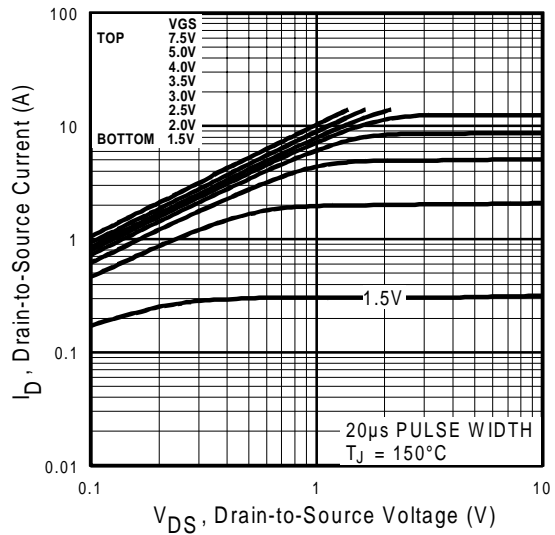

Fig 2. Typical Output Characteristics

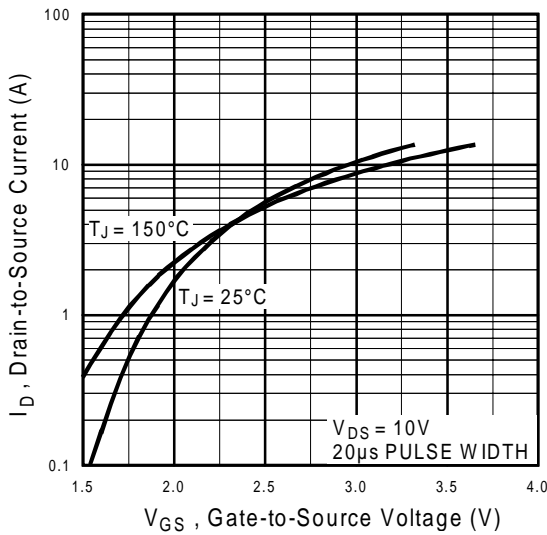

Fig 3. Typical Transfer Characteristics

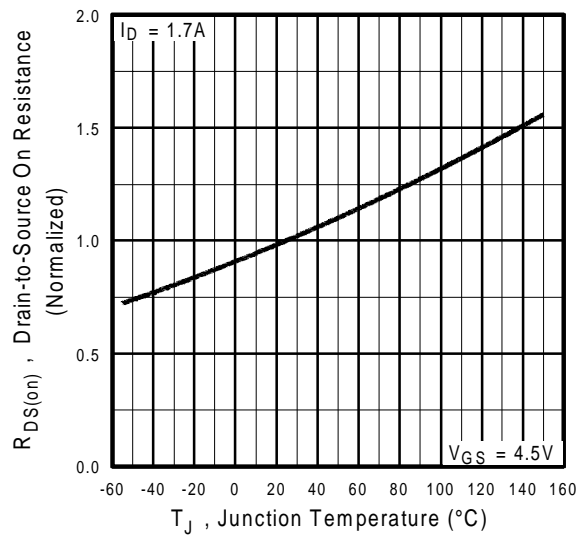
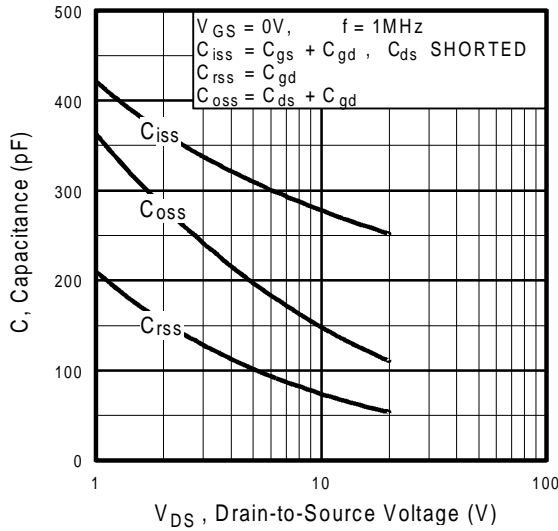
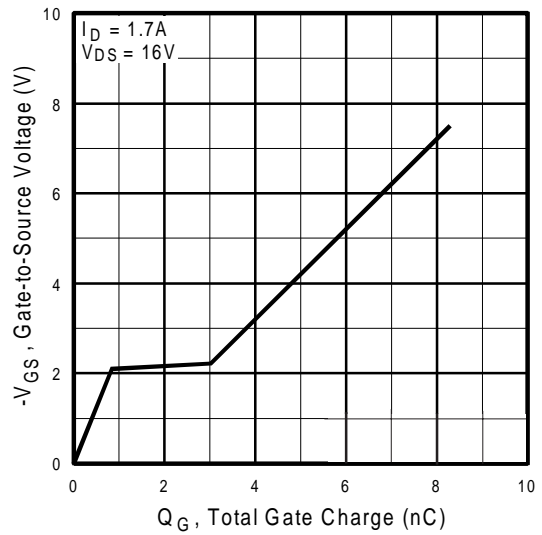

Fig 4. Normalized On-Resistance Vs. Temperature

**Power Mosfet Characteristics**



**Fig 5.** Typical Capacitance Vs. Drain-to-Source Voltage



**Fig 6.** Typical Gate Charge Vs. Gate-to-Source Voltage

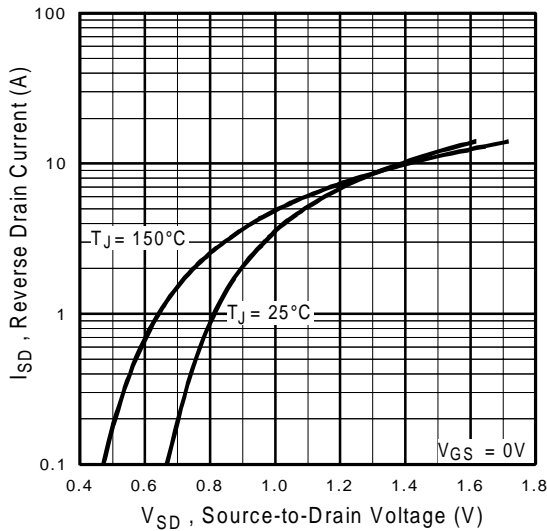

**Fig 7.** Typical Source-Drain Diode Forward Voltage

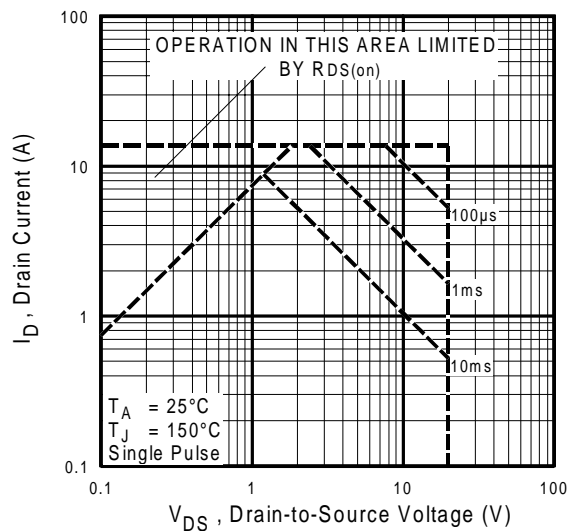

**Fig 8.** Maximum Safe Operating Area

Power Mosfet Characteristics

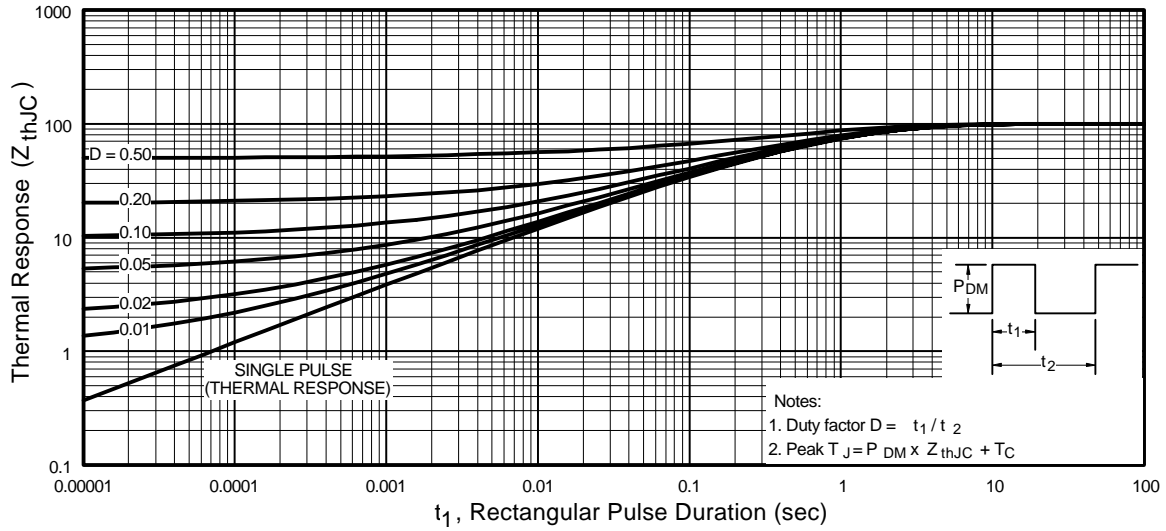

Fig 9. Maximum Effective Transient Thermal Impedance, Junction-to-Ambient

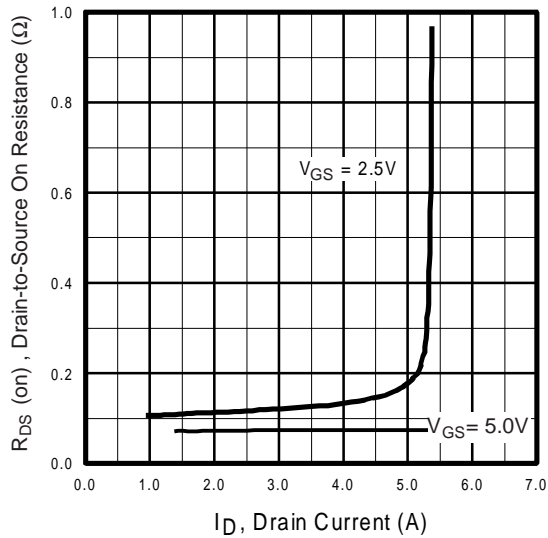

Fig 10. Typical On-Resistance Vs. Drain Current

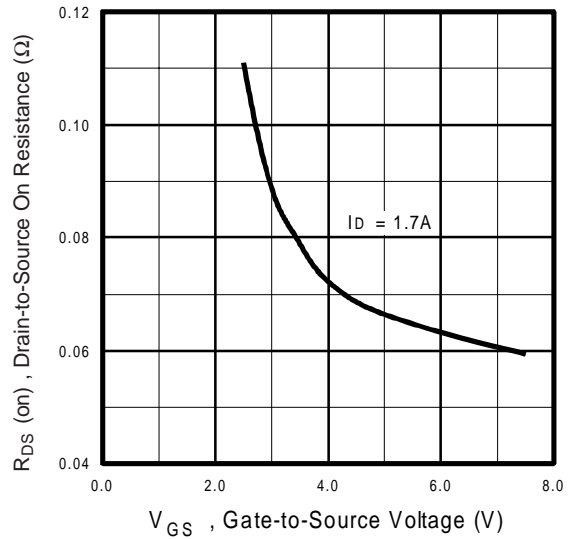

Fig 11. Typical On-Resistance Vs. Gate Voltage

Schottky Diode Characteristics

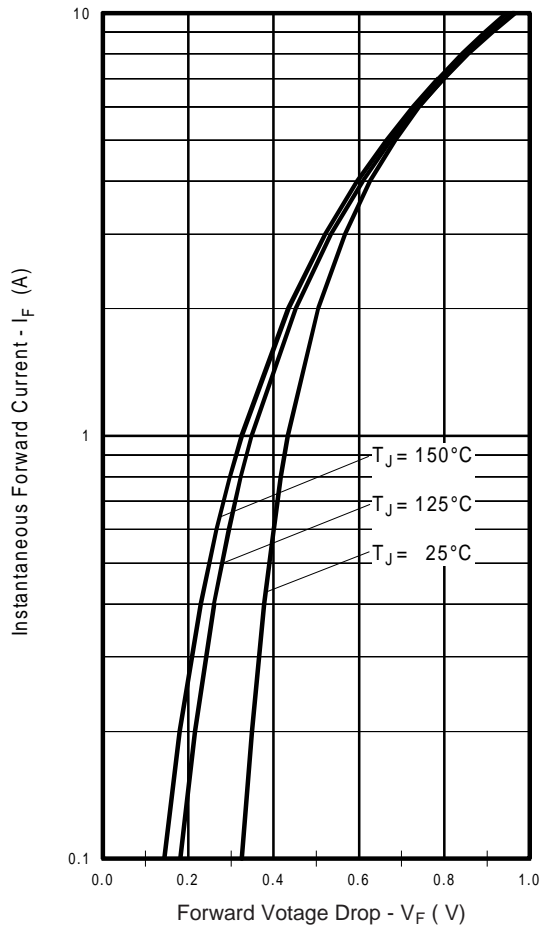

Fig. 12 -Typical Forward Voltage Drop Characteristics

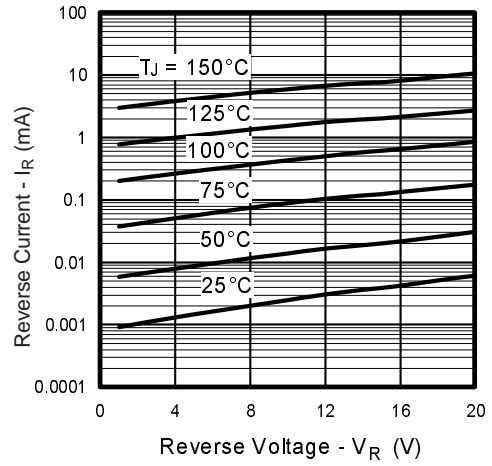

Fig. 13 - Typical Values of Reverse Current Vs. Reverse Voltage

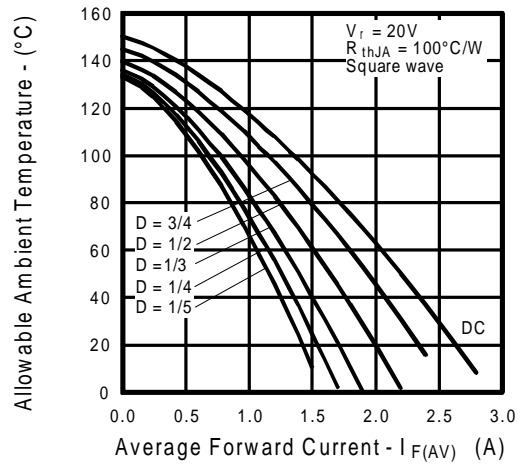
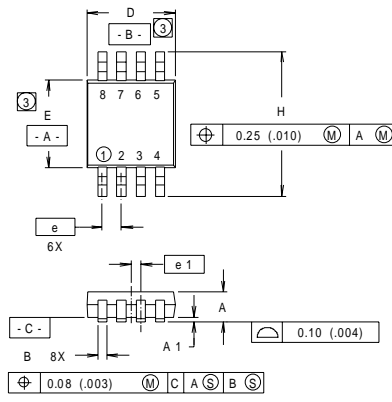

Fig.14 - Maximum Allowable Ambient Temp. Vs. Forward Current

International  
**IOR** Rectifier  
**Micro8™** Package Details

**IRF7521D1**



**LEAD ASSIGNMENTS**

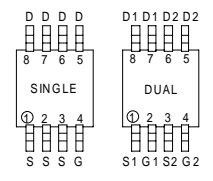

DIM	INCHES		MILLIMETERS	
	MIN	MAX	MIN	MAX
A	.036	.044	0.91	1.11
A1	.004	.008	0.10	0.20
B	.010	.014	0.25	0.36
C	.005	.007	0.13	0.18
D	.116	.120	2.95	3.05
e	.0256 BASIC		0.65 BASIC	
e1	.0128 BASIC		0.33 BASIC	
E	.116	.120	2.95	3.05
H	.188	.198	4.78	5.03
L	.016	.026	0.41	0.66
θ	0°	6°	0°	6°

**RECOMMENDED FOOTPRINT**

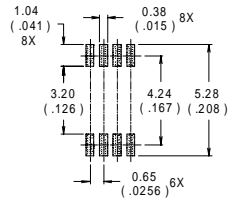

- NOTES:**  
 1 DIMENSIONING AND TOLERANCING PER ANSI Y14.5M-1982.  
 2 CONTROLLING DIMENSION : INCH.  
 3 DIMENSIONS DO NOT INCLUDE MOLD FLASH.

**Part Marking**

EXAMPLE: THIS IS AN IRF7501

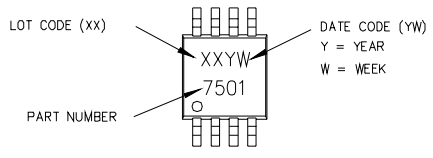

WW = (1-26) IF PRECEDED BY LAST DIGIT OF CALENDAR YEAR

YEAR	Y	WORK WEEK	W
2001	1	01	A
2002	2	02	B
2003	3	03	C
1994	4	04	D
1995	5		
1996	6		
1997	7		
1998	8		
1999	9		
2000	0	24	X
		25	Y
		26	Z

DATE CODE EXAMPLES:  
 YWW = 9503 = 5C  
 YWW = 9532 = EF

WW = (27-52) IF PRECEDED BY A LETTER

YEAR	Y	WORK WEEK	W
2001	A	27	A
2002	B	28	B
2003	C	29	C
1994	D	30	D
1995	E		
1996	F		
1997	G		
1998	H		
1999	J		
2000	K	50	X
		51	Y
		52	Z

# IRF7521D1

International  
**IR** Rectifier

## Micro8™ Tape & Reel

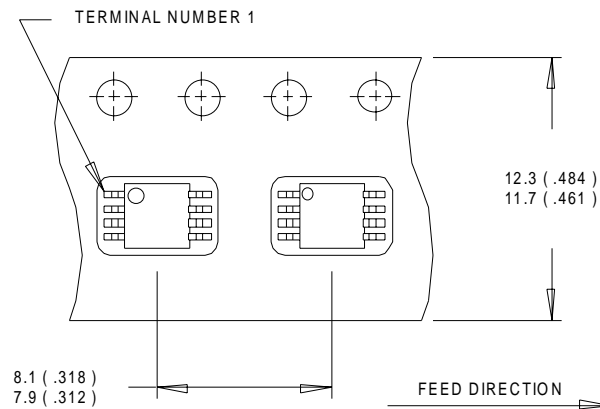

- NOTES:
1. OUTLINE CONFORMS TO EIA-481 & EIA-541.
  2. CONTROLLING DIMENSION : MILLIMETER.

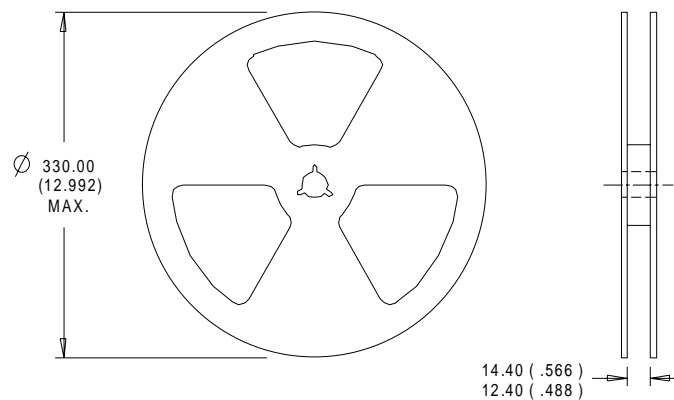

- NOTES :
1. CONTROLLING DIMENSION : MILLIMETER.
  2. OUTLINE CONFORMS TO EIA-481 & EIA-541.

International  
**IR** Rectifier

**WORLD HEADQUARTERS:** 233 Kansas St., El Segundo, California 90245, Tel: (310) 322 3331

**IR GREAT BRITAIN:** Hurst Green, Oxted, Surrey RH8 9BB, UK Tel: ++ 44 1883 732020

**IR CANADA:** 15 Lincoln Court, Brampton, Ontario L6T3Z2, Tel: (905) 453 2200

**IR GERMANY:** Saalburgstrasse 157, 61350 Bad Homburg Tel: ++ 49 6172 96590

**IR ITALY:** Via Liguria 49, 10071 Borgaro, Torino Tel: ++ 39 11 451 0111

**IR FAR EAST:** K&H Bldg., 2F, 30-4 Nishi-Ikebukuro 3-Chome, Toshima-Ku, Tokyo Japan 171 Tel: 81 3 3983 0086

**IR SOUTHEAST ASIA:** 1 Kim Seng Promenade, Great World City West Tower, 13-11, Singapore 237994 Tel: ++ 65 221 8371

**IR TAIWAN:** 16 Fl. Suite D. 207, Sec. 2, Tun Haw South Road, Taipei, 10673, Taiwan Tel: 886-2-2377-9936

<http://www.irf.com/> Data and specifications subject to change without notice . 01/99