

IRL2203N

HEXFET[®] Power MOSFET

- Advanced Process Technology
- Ultra Low On-Resistance
- Dynamic dv/dt Rating
- 175°C Operating Temperature
- Fast Switching
- Fully Avalanche Rated

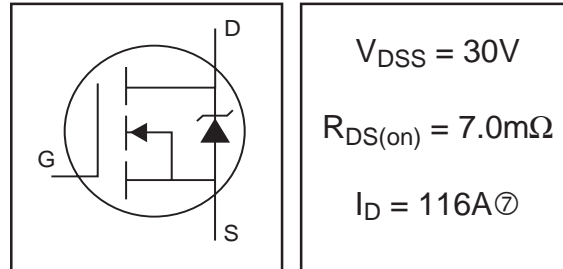

Description

Advanced HEXFET[®] Power MOSFETs from International Rectifier utilize advanced processing techniques to achieve extremely low on-resistance per silicon area. This benefit, combined with the fast switching speed and ruggedized device design that HEXFET power MOSFETs are well known for, provides the designer with an extremely efficient and reliable device for use in a wide variety of applications.

The TO-220 package is universally preferred for all commercial-industrial applications at power dissipation levels to approximately 50 watts. The low thermal resistance and low package cost of the TO-220 contribute to its wide acceptance throughout the industry.



Absolute Maximum Ratings

| | Parameter | Max. | Units |
|-----------------------------|--|--------------------|-------|
| I_D @ $T_C = 25^\circ C$ | Continuous Drain Current, V_{GS} @ 10V | 116 ^⑦ | A |
| I_D @ $T_C = 100^\circ C$ | Continuous Drain Current, V_{GS} @ 10V | 82 | |
| I_{DM} | Pulsed Drain Current ^① | 400 | |
| P_D @ $T_C = 25^\circ C$ | Power Dissipation | 180 | W |
| | Linear Derating Factor | 1.2 | W/°C |
| V_{GS} | Gate-to-Source Voltage | ± 16 | V |
| I_{AR} | Avalanche Current ^① | 60 | A |
| E_{AR} | Repetitive Avalanche Energy ^① | 18 | mJ |
| dv/dt | Peak Diode Recovery dv/dt ^③ | 5.0 | V/ns |
| T_J | Operating Junction and | -55 to + 175 | °C |
| T_{STG} | Storage Temperature Range | | |
| | Soldering Temperature, for 10 seconds | | |
| | Mounting torque, 6-32 or M3 srew | 10 lbf•in (1.1N•m) | |

Thermal Resistance

| | Parameter | Typ. | Max. | Units |
|-----------------|-------------------------------------|------|------|-------|
| $R_{\theta JC}$ | Junction-to-Case | — | 0.85 | °C/W |
| $R_{\theta CS}$ | Case-to-Sink, Flat, Greased Surface | 0.50 | — | |
| $R_{\theta JA}$ | Junction-to-Ambient | — | 62 | |

IRL2203N

International
IR Rectifier

Electrical Characteristics @ $T_J = 25^\circ\text{C}$ (unless otherwise specified)

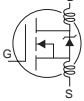
| | Parameter | Min. | Typ. | Max. | Units | Conditions |
|---------------------------------|--------------------------------------|------|-------|------|---------------------|--|
| $V_{(BR)DSS}$ | Drain-to-Source Breakdown Voltage | 30 | — | — | V | $V_{GS} = 0V, I_D = 250\mu A$ |
| $\Delta V_{(BR)DSS}/\Delta T_J$ | Breakdown Voltage Temp. Coefficient | — | 0.029 | — | V/ $^\circ\text{C}$ | Reference to $25^\circ\text{C}, I_D = 1\text{mA}$ |
| $R_{DS(on)}$ | Static Drain-to-Source On-Resistance | — | — | 7.0 | m Ω | $V_{GS} = 10V, I_D = 60A$ ④ |
| | | — | — | 10 | | $V_{GS} = 4.5V, I_D = 48A$ ④ |
| $V_{GS(th)}$ | Gate Threshold Voltage | 1.0 | — | — | V | $V_{DS} = V_{GS}, I_D = 250\mu A$ |
| g_{fs} | Forward Transconductance | 73 | — | — | S | $V_{DS} = 25V, I_D = 60A$ ④ |
| I_{DSS} | Drain-to-Source Leakage Current | — | — | 25 | μA | $V_{DS} = 30V, V_{GS} = 0V$ |
| | | — | — | 250 | | $V_{DS} = 24V, V_{GS} = 0V, T_J = 125^\circ\text{C}$ |
| I_{GSS} | Gate-to-Source Forward Leakage | — | — | 100 | nA | $V_{GS} = 16V$ |
| | Gate-to-Source Reverse Leakage | — | — | -100 | | $V_{GS} = -16V$ |
| Q_g | Total Gate Charge | — | — | 60 | nC | $I_D = 60A$ |
| Q_{gs} | Gate-to-Source Charge | — | — | 14 | | $V_{DS} = 24V$ |
| Q_{gd} | Gate-to-Drain ("Miller") Charge | — | — | 33 | | $V_{GS} = 4.5V$, See Fig. 6 and 13 |
| $t_{d(on)}$ | Turn-On Delay Time | — | 11 | — | nH | $V_{DD} = 15V$ |
| t_r | Rise Time | — | 160 | — | | $I_D = 60A$ |
| $t_{d(off)}$ | Turn-Off Delay Time | — | 23 | — | | $R_G = 1.8\Omega$ |
| t_f | Fall Time | — | 66 | — | | $V_{GS} = 4.5V$, See Fig. 10 ④ |
| L_D | Internal Drain Inductance | — | 4.5 | — | nH | Between lead, 6mm (0.25in.) from package and center of die contact |
| L_S | Internal Source Inductance | — | 7.5 | — | |  |
| C_{iss} | Input Capacitance | — | 3290 | — | pF | $V_{GS} = 0V$ |
| C_{oss} | Output Capacitance | — | 1270 | — | | $V_{DS} = 25V$ |
| C_{rss} | Reverse Transfer Capacitance | — | 170 | — | | $f = 1.0\text{MHz}$, See Fig. 5 |
| E_{AS} | Single Pulse Avalanche Energy② | — | 1320⑤ | 290⑥ | mJ | $I_{AS} = 60A, L = 0.16\text{mH}$ |

Source-Drain Ratings and Characteristics

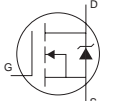
| | Parameter | Min. | Typ. | Max. | Units | Conditions |
|----------|---|---|------|------|-------|--|
| I_S | Continuous Source Current (Body Diode) | — | — | 116⑦ | A | MOSFET symbol showing the integral reverse p-n junction diode.  |
| I_{SM} | Pulsed Source Current (Body Diode)① | — | — | 400 | | |
| V_{SD} | Diode Forward Voltage | — | — | 1.2 | V | $T_J = 25^\circ\text{C}, I_S = 60A, V_{GS} = 0V$ ④ |
| t_{rr} | Reverse Recovery Time | — | 56 | 84 | ns | $T_J = 25^\circ\text{C}, I_F = 60A$ |
| Q_{rr} | Reverse Recovery Charge | — | 110 | 170 | nC | $di/dt = 100A/\mu s$ ④ |
| t_{on} | Forward Turn-On Time | Intrinsic turn-on time is negligible (turn-on is dominated by L_S+L_D) | | | | |

Notes:

- ① Repetitive rating; pulse width limited by max. junction temperature. (See fig. 11)
- ② Starting $T_J = 25^\circ\text{C}, L = 0.16\text{mH}$
 $R_G = 25\Omega, I_{AS} = 60A, V_{GS} = 10V$ (See Figure 12)
- ③ $I_{SD} \leq 60A, di/dt \leq 110A/\mu s, V_{DD} \leq V_{(BR)DSS}, T_J \leq 175^\circ\text{C}$
- ④ Pulse width $\leq 400\mu s$; duty cycle $\leq 2\%$.
- ⑤ This is a typical value at device destruction and represents operation outside rated limits.
- ⑥ This is a calculated value limited to $T_J = 175^\circ\text{C}$.
- ⑦ Calculated continuous current based on maximum allowable junction temperature. Package limitation current is 75A.

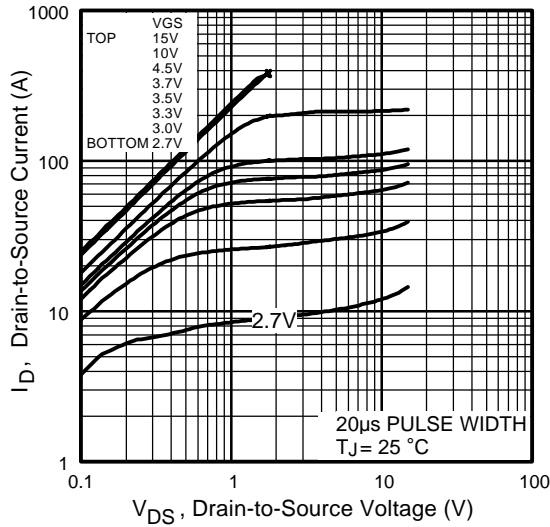

Fig 1. Typical Output Characteristics

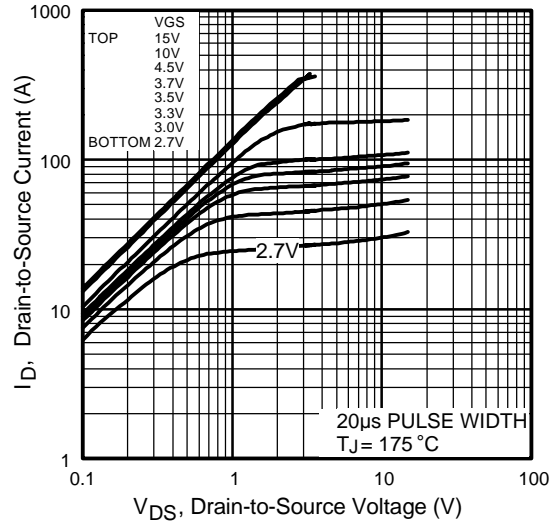

Fig 2. Typical Output Characteristics

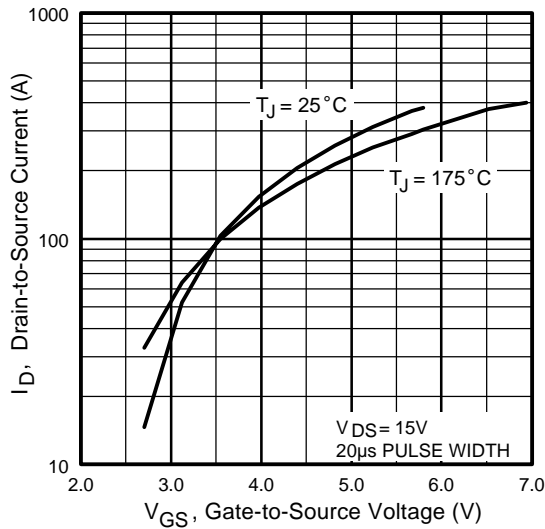

Fig 3. Typical Transfer Characteristics

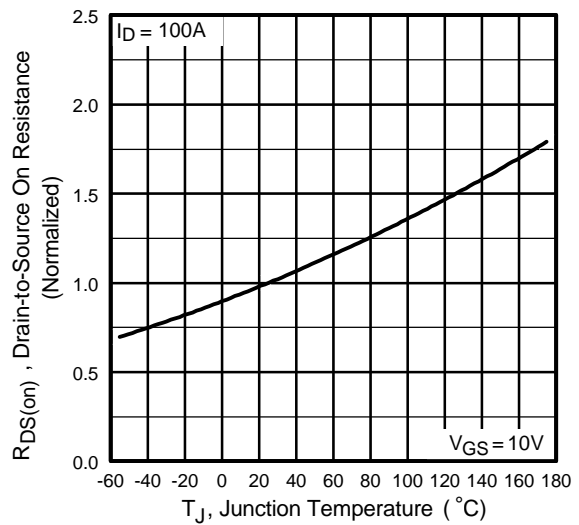

Fig 4. Normalized On-Resistance Vs. Temperature

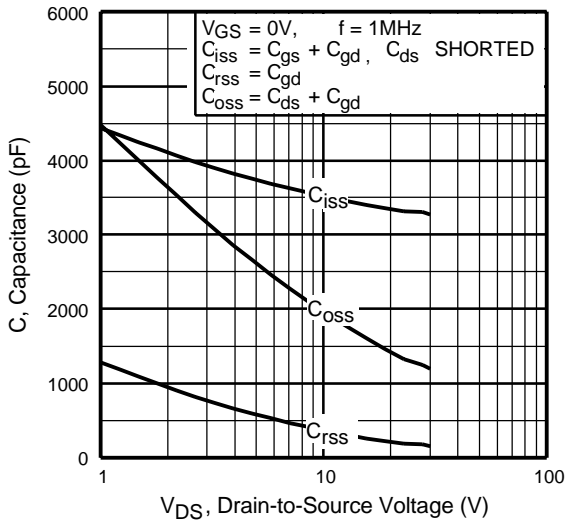

Fig 5. Typical Capacitance Vs. Drain-to-Source Voltage

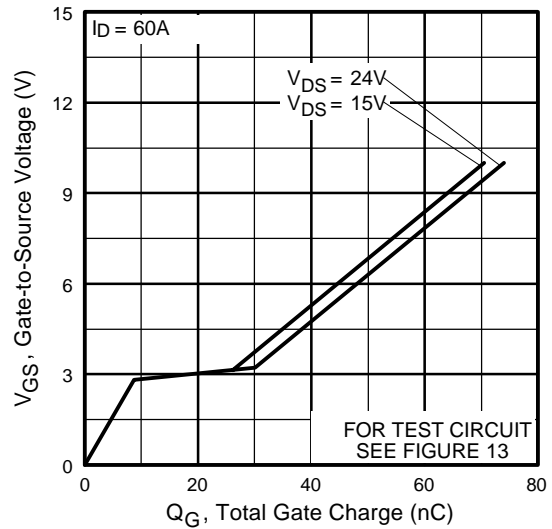

Fig 6. Typical Gate Charge Vs. Gate-to-Source Voltage

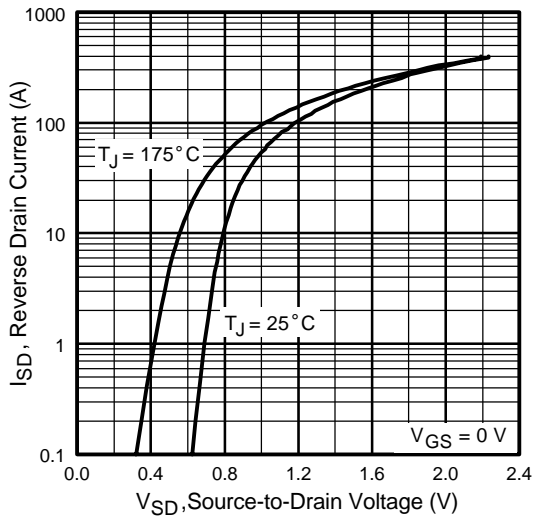

Fig 7. Typical Source-Drain Diode Forward Voltage

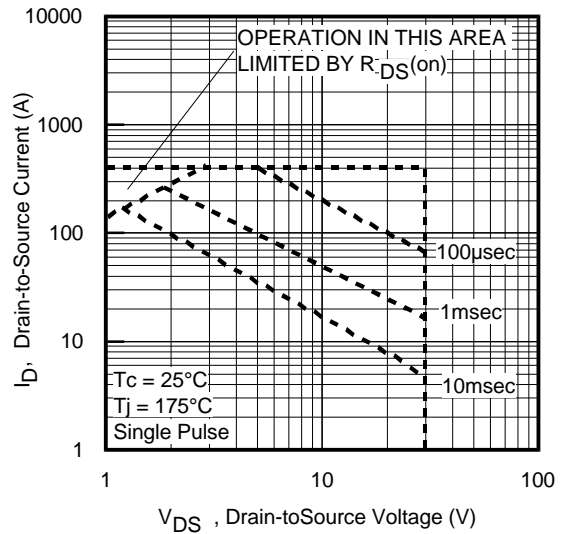

Fig 8. Maximum Safe Operating Area

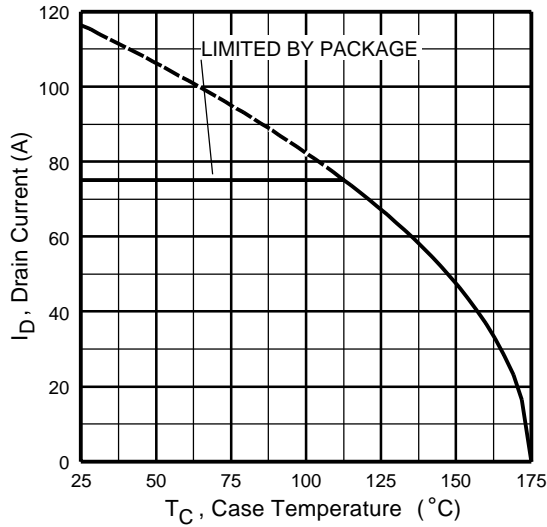

Fig 9. Maximum Drain Current Vs. Case Temperature



Fig 10a. Switching Time Test Circuit



Fig 10b. Switching Time Waveforms

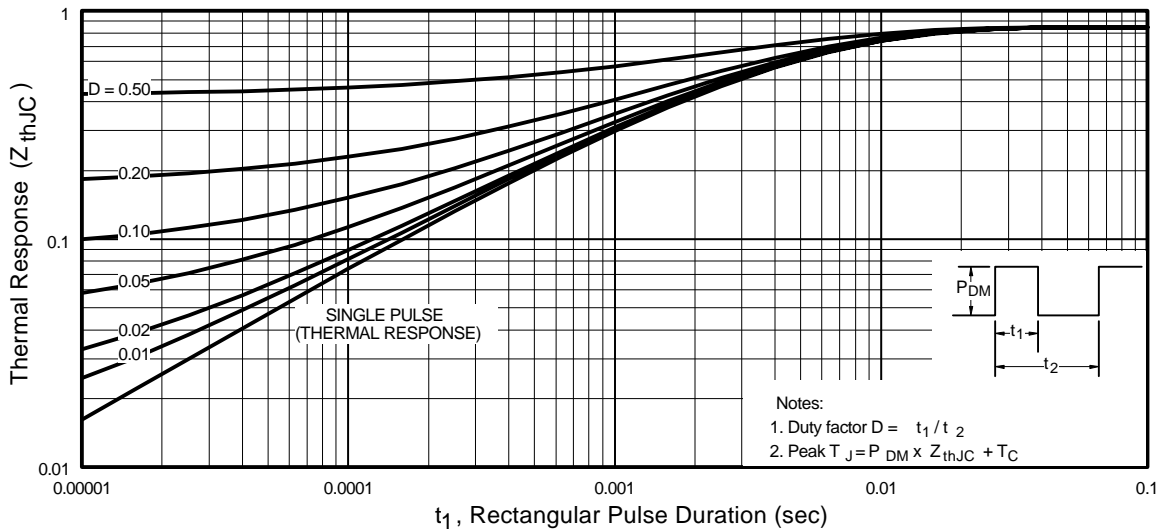

Fig 11. Maximum Effective Transient Thermal Impedance, Junction-to-Case

IRL2203N

International
IR Rectifier

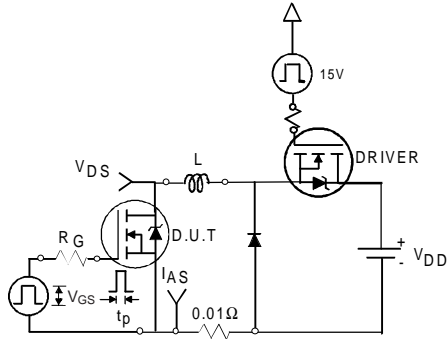

Fig 12a. Unclamped Inductive Test Circuit



Fig 12b. Unclamped Inductive Waveforms

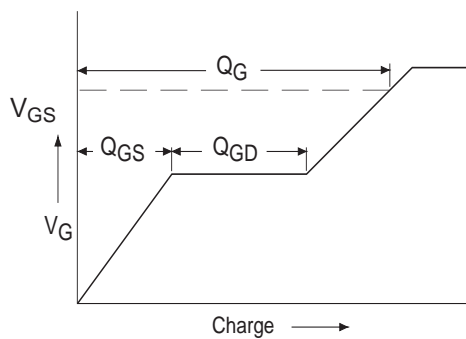

Fig 13a. Basic Gate Charge Waveform

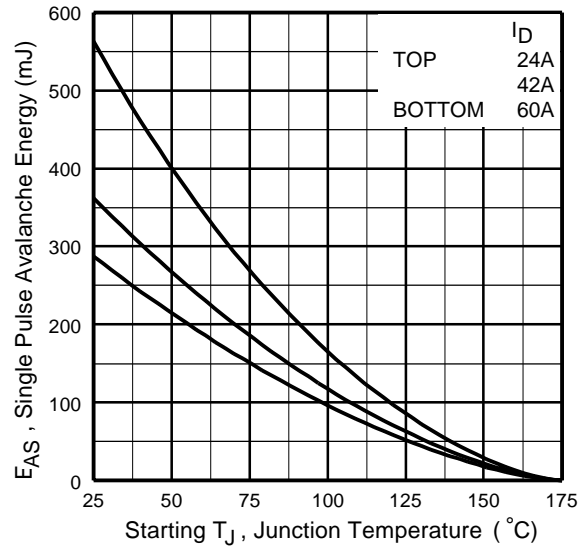

Fig 12c. Maximum Avalanche Energy Vs. Drain Current

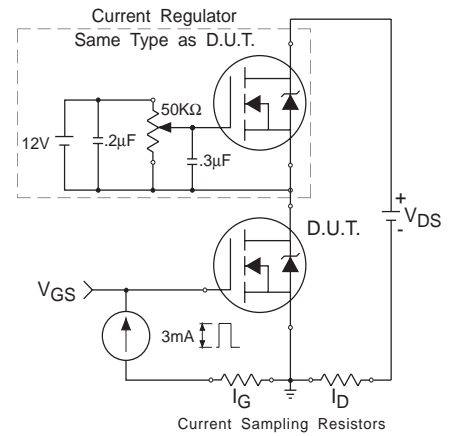
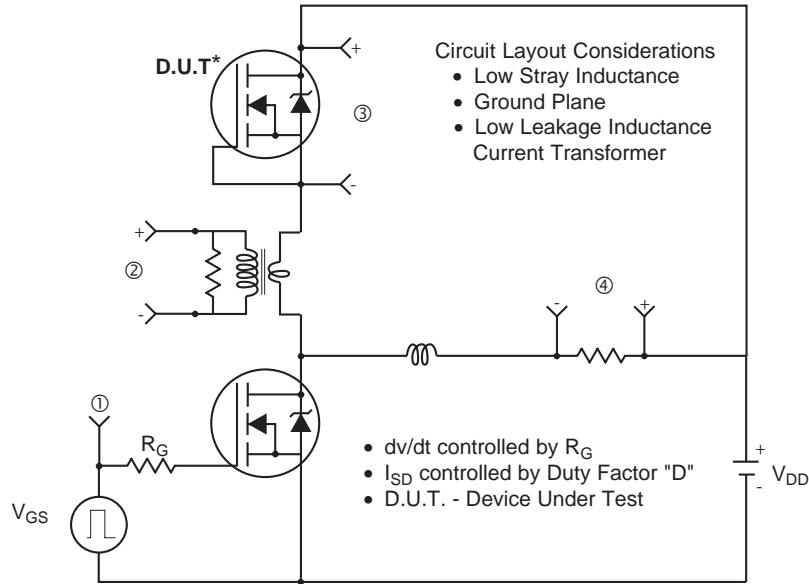
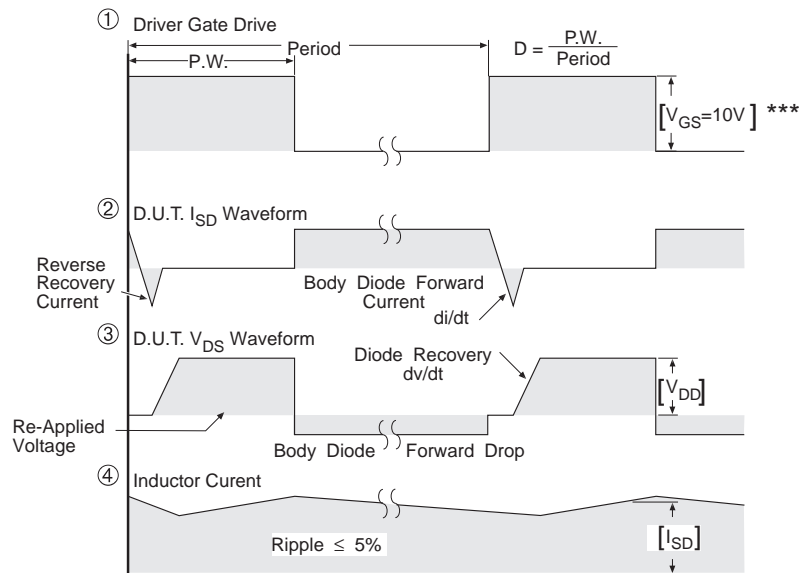

Fig 13b. Gate Charge Test Circuit

Peak Diode Recovery dv/dt Test Circuit



* Reverse Polarity of D.U.T for P-Channel



*** $V_{GS} = 5.0V$ for Logic Level and 3V Drive Devices

Fig 14. For N-channel HEXFET® power MOSFETs

IRL2203N

International
IR Rectifier

Package Outline

TO-220AB

Dimensions are shown in millimeters (inches)

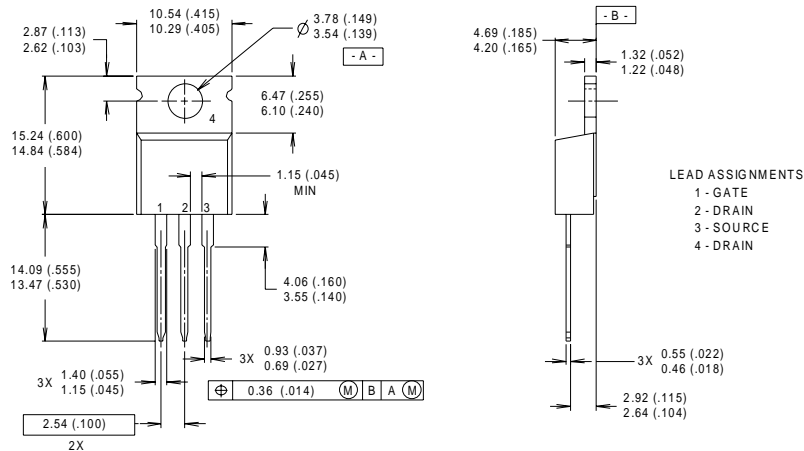

NOTES:

1 DIMENSIONING & TOLERANCING PER ANSII Y14.5M, 1982.
2 CONTROLLING DIMENSION : INCH

3 OUTLINE CONFORMS TO JEDEC OUTLINE TO-220AB.
4 HEATSINK & LEAD MEASUREMENTS DO NOT INCLUDE BURRS.

Part Marking Information

TO-220AB

EXAMPLE : THIS IS AN IRF1010
WITH ASSEMBLY
LOT CODE 9B1M

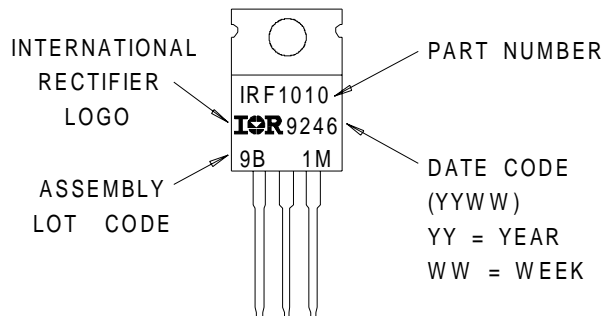

Data and specifications subject to change without notice.
This product has been designed and qualified for the industrial market.
Qualification Standards can be found on IR's Web site.

International
IR Rectifier

IR WORLD HEADQUARTERS: 233 Kansas St., El Segundo, California 90245, USA Tel: (310) 252-7105
TAC Fax: (310) 252-7903

Visit us at www.irf.com for sales contact information. 3/01

www.irf.com

Note: For the most current drawings please refer to the IR website at:
<http://www.irf.com/package/>