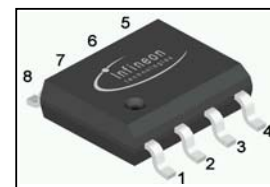

**OptiMOS™-P Power-Transistor**
**Features**

- P-Channel
- Enhancement mode
- Logic level
- 150°C operating temperature
- Avalanche rated
- $dv/dt$  rated
- Ideal for fast switching buck converter

**Product Summary**

$V_{DS}$	-30	V
$R_{DS(on),max}$	20	m $\Omega$
$I_D$	-9.1	A

**P-DSO-8**

Type	Package	Marking
BSO200P03S	P-DSO-8	200P3S

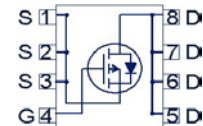
**Maximum ratings, at  $T_j=25\text{ °C}$ , unless otherwise specified**

Parameter	Symbol	Conditions	Value		Unit
			$\leq 10$ secs	steady state	
Continuous drain current	$I_D$	$T_A=25\text{ °C}^{(1)}$	-9.1	-7.4	A
		$T_A=70\text{ °C}^{(1)}$	-7.3	-5.9	
Pulsed drain current	$I_{D,pulse}$	$T_A=25\text{ °C}^{(2)}$	-37		
Avalanche energy, single pulse	$E_{AS}$	$I_D=-9.1\text{ A}$ , $R_{GS}=25\text{ }\Omega$	98		mJ
Reverse diode $dv/dt$	$dv/dt$	$I_D=-9.1\text{ A}$ , $V_{DS}=20\text{ V}$ , $di/dt=-200\text{ A}/\mu\text{s}$ , $T_{j,max}=150\text{ °C}$	-6		kV/ $\mu\text{s}$
Gate source voltage	$V_{GS}$		$\pm 25$		V
Power dissipation	$P_{tot}$	$T_A=25\text{ °C}^{(1)}$	2.36	1.56	W
Operating and storage temperature	$T_j$ , $T_{stg}$		-55 ... 150		$^{\circ}\text{C}$
IEC climatic category; DIN IEC 68-1			55/150/56		

Parameter	Symbol	Conditions	Values			Unit
			min.	typ.	max.	

**Thermal characteristics**

Thermal resistance, junction - soldering point	$R_{thJS}$		-	-	35	K/W
Thermal resistance, junction - ambient	$R_{thJA}$	minimal footprint, $t_p \leq 10$ s	-	-	110	
		minimal footprint, steady state	-	-	150	
		6 cm <sup>2</sup> cooling area <sup>1)</sup> , $t_p \leq 10$ s	-	-	53	
		6 cm <sup>2</sup> cooling area <sup>1)</sup> , steady state	-	-	80	

**Electrical characteristics, at  $T_j=25$  °C, unless otherwise specified**
**Static characteristics**

Drain-source breakdown voltage	$V_{(BR)DSS}$	$V_{GS}=0$ V, $I_D=-250$ $\mu$ A	-30	-	-	V
Gate threshold voltage	$V_{GS(th)}$	$V_{DS}=V_{GS}$ , $I_D=-100$ $\mu$ A	-1	-1.5		
Zero gate voltage drain current	$I_{DSS}$	$V_{DS}=-30$ V, $V_{GS}=0$ V, $T_j=25$ °C	-	-0.1	-1	$\mu$ A
		$V_{DS}=-30$ V, $V_{GS}=0$ V, $T_j=125$ °C	-	-10	-100	
Gate-source leakage current	$I_{GSS}$	$V_{GS}=-25$ V, $V_{DS}=0$ V	-	-10	-100	nA
Drain-source on-state resistance	$R_{DS(on)}$	$V_{GS}=-10$ V, $I_D=-9.1$ A	-	16.7	20.0	
Transconductance	$g_{fs}$	$ V_{DS}  > 2 I_D  R_{DS(on)max}$ , $I_D=-7.3$ A	11	21	-	S

<sup>1)</sup> Device on 40 mm x 40 mm x 1.5 mm epoxy PCB FR4 with 6 cm<sup>2</sup> (one layer, 70  $\mu$ m thick) copper area for drain connection. PCB is vertical in still air.

Parameter	Symbol	Conditions	Values			Unit
			min.	typ.	max.	

**Dynamic characteristics**

Input capacitance	$C_{iss}$	$V_{GS}=0\text{ V}$ , $V_{DS}=-25\text{ V}$ , $f=1\text{ MHz}$	-	1750	2330	pF
Output capacitance	$C_{oss}$		-	470	625	
Reverse transfer capacitance	$C_{rss}$		-	390	580	
Turn-on delay time	$t_{d(on)}$	$V_{DD}=-15\text{ V}$ , $V_{GS}=-10\text{ V}$ , $I_D=-1\text{ A}$ , $R_G=6\ \Omega$	-	10	53	ns
Rise time	$t_r$		-	11	17	
Turn-off delay time	$t_{d(off)}$		-	42	63	
Fall time	$t_f$		-	33	50	

**Gate Charge Characteristics<sup>3)</sup>**

Gate to source charge	$Q_{gs}$	$V_{DD}=-24\text{ V}$ , $I_D=9.1\text{ A}$ , $V_{GS}=0\text{ to }-10\text{ V}$	-	-4.8	-6.4	nC
Gate charge at threshold	$Q_{g(th)}$		-	-2.6	-3.5	
Gate to drain charge	$Q_{gd}$		-	-14		
Switching charge	$Q_{sw}$		-	-16	-24	
Gate charge total	$Q_g$		-	-40	-54	
Gate plateau voltage	$V_{plateau}$		-	-2.7	-	V
Output charge	$Q_{oss}$	$V_{DD}=-15\text{ V}$ , $V_{GS}=0\text{ V}$	-	-14	-19	

**Reverse Diode**

Diode continuous forward current	$I_S$	$T_A=25\text{ }^\circ\text{C}$	-	-	-2.1	A
Diode pulse current	$I_{S,pulse}$		-	-	-36.5	
Diode forward voltage	$V_{SD}$	$V_{GS}=0\text{ V}$ , $I_F=-9.1\text{ A}$ , $T_j=25\text{ }^\circ\text{C}$	-	-0.88	-1.2	V
Reverse recovery time	$t_{rr}$	$V_R=15\text{ V}$ , $I_F=-9.1\text{ A}$ , $di_F/dt=100\text{ A}/\mu\text{s}$	-	19	24	ns
Reverse recovery charge	$Q_{rr}$		-	9	11	nC

<sup>2)</sup> See figure 3

<sup>3)</sup> See figure 16 for gate charge parameter definition

**1 Power dissipation**

$P_{tot}=f(T_A); t_p \leq 10 \text{ s}$

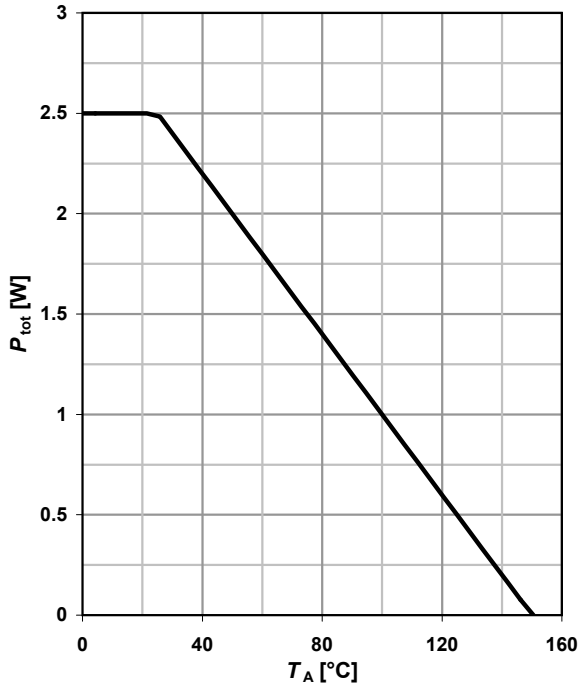

**2 Drain current**

$I_D=f(T_A); |V_{GS}| \geq 10 \text{ V}; t_p \leq 10 \text{ s}$

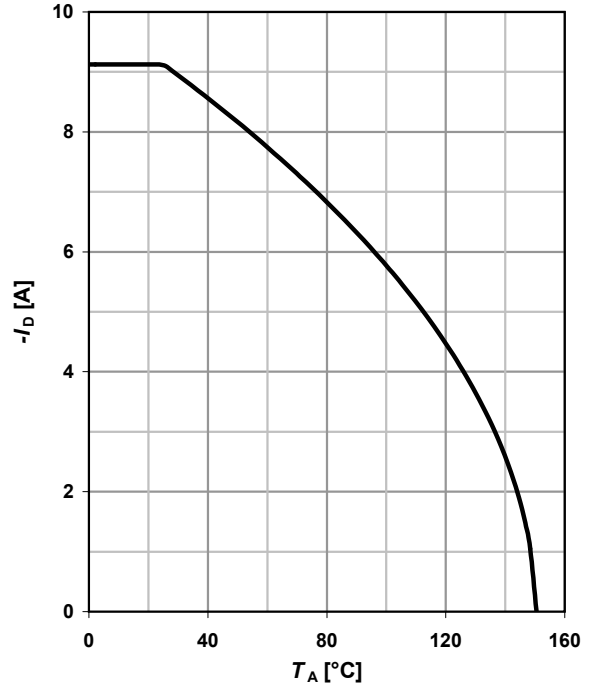

**3 Safe operating area**

$I_D=f(V_{DS}); T_A=25 \text{ °C}^1; D=0$

parameter:  $t_p$

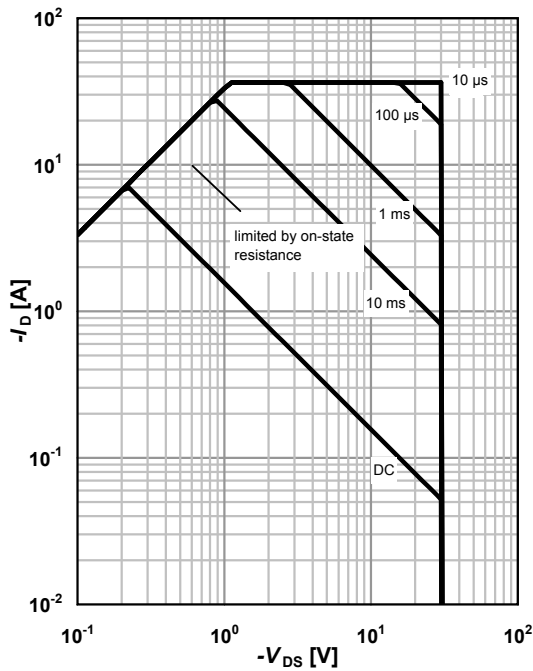

**4 Max. transient thermal impedance**

$Z_{thJS}=f(t_p)$

parameter:  $D=t_p/T$

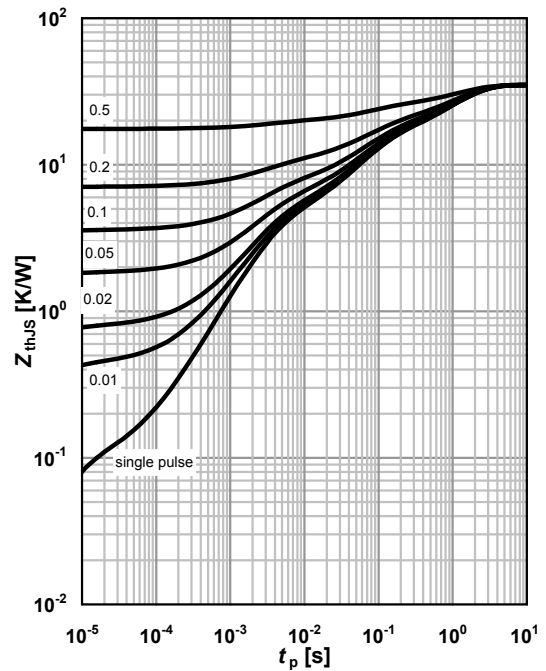

**5 Typ. output characteristics**

$I_D = f(V_{DS}); T_j = 25\text{ }^\circ\text{C}$

parameter:  $V_{GS}$

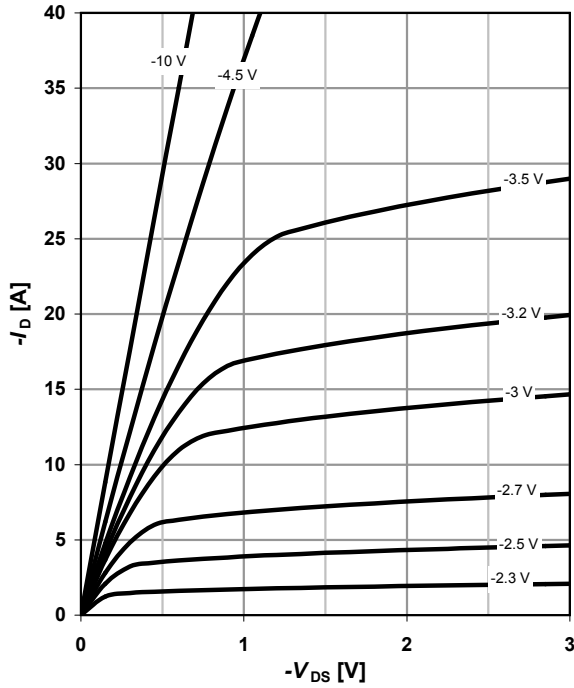

**6 Typ. drain-source on resistance**

$R_{DS(on)} = f(I_D); T_j = 25\text{ }^\circ\text{C}$

parameter:  $V_{GS}$

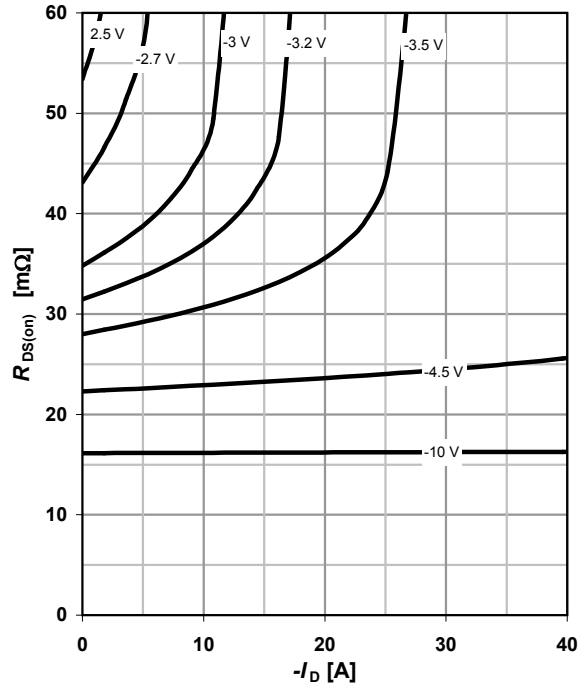

**7 Typ. transfer characteristics**

$I_D = f(V_{GS}); |V_{DS}| > 2|I_D|R_{DS(on)max}$

parameter:  $T_j$

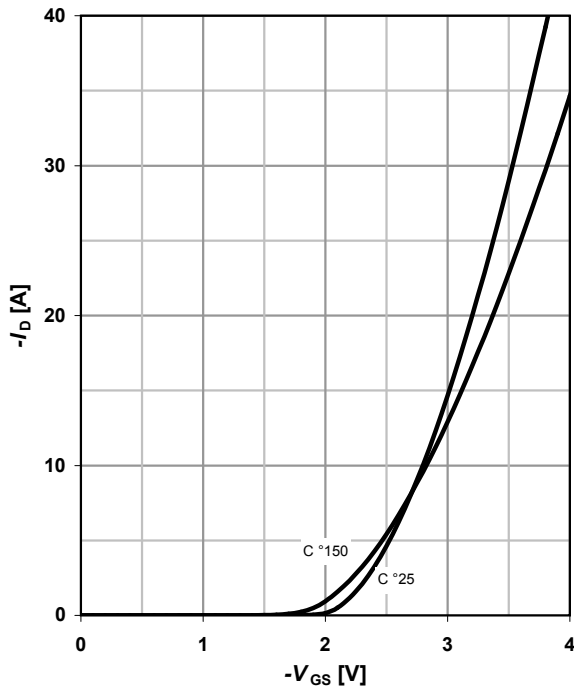

**8 Typ. forward transconductance**

$g_{fs} = f(I_D); T_j = 25\text{ }^\circ\text{C}$

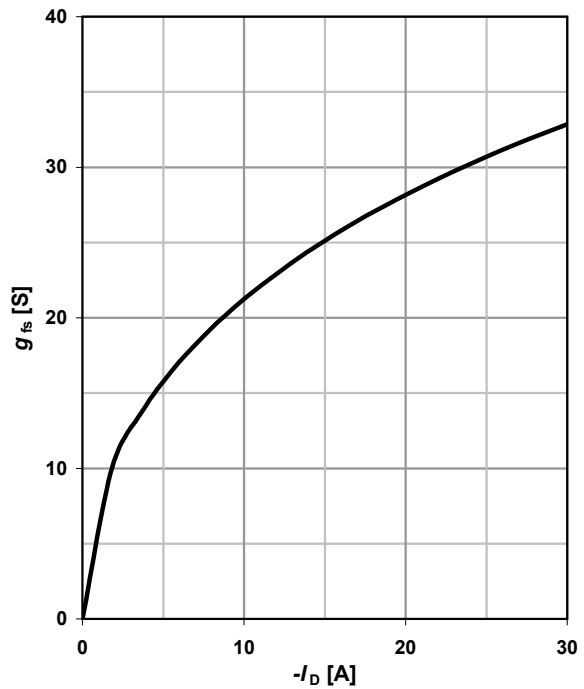

**9 Drain-source on-state resistance**

$$R_{DS(on)} = f(T_j); I_D = -9.1 \text{ A}; V_{GS} = -10 \text{ V}$$

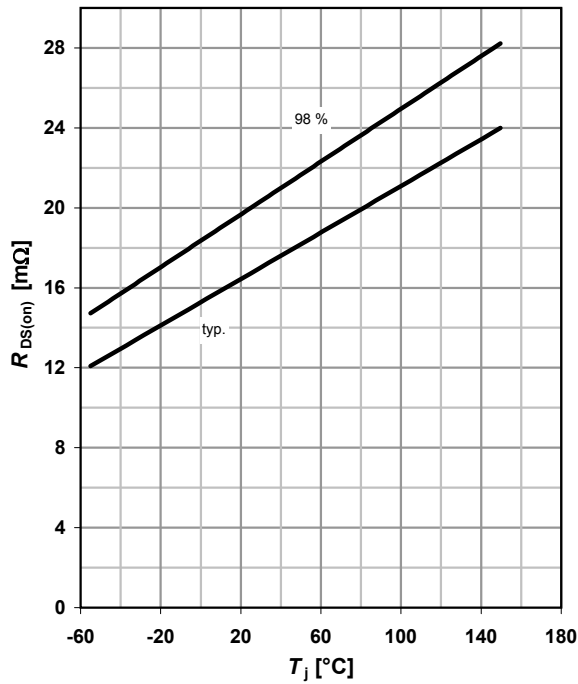

**10 Typ. gate threshold voltage**

$$V_{GS(th)} = f(T_j); V_{GS} = V_{DS}; I_D = -100 \mu\text{A}$$

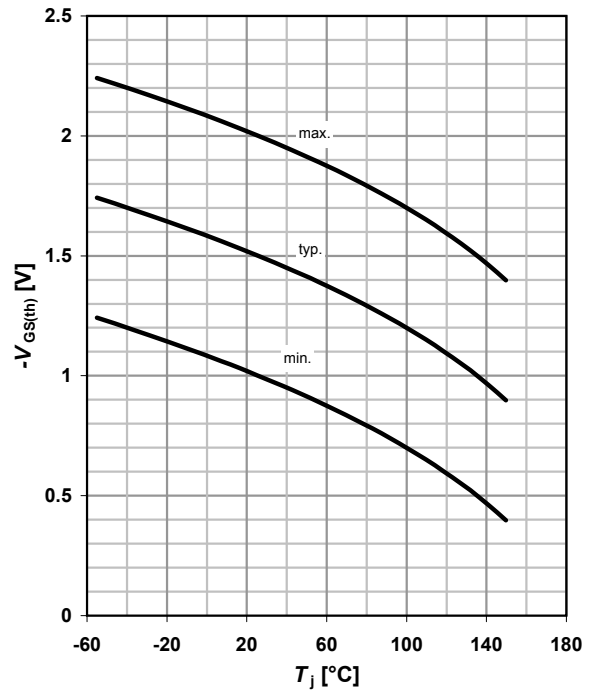

**11 Typ. capacitances**

$$C = f(V_{DS}); V_{GS} = 0 \text{ V}; f = 1 \text{ MHz}$$

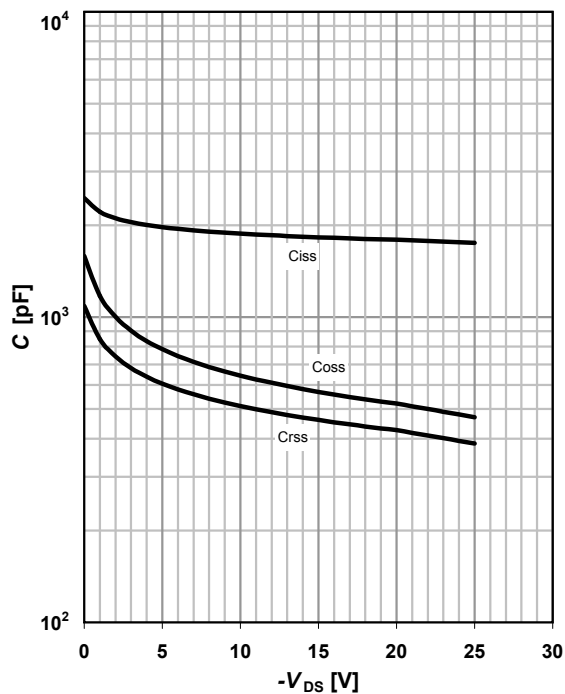

**12 Forward characteristics of reverse diode**

$$I_F = f(V_{SD})$$

parameter:  $T_j$

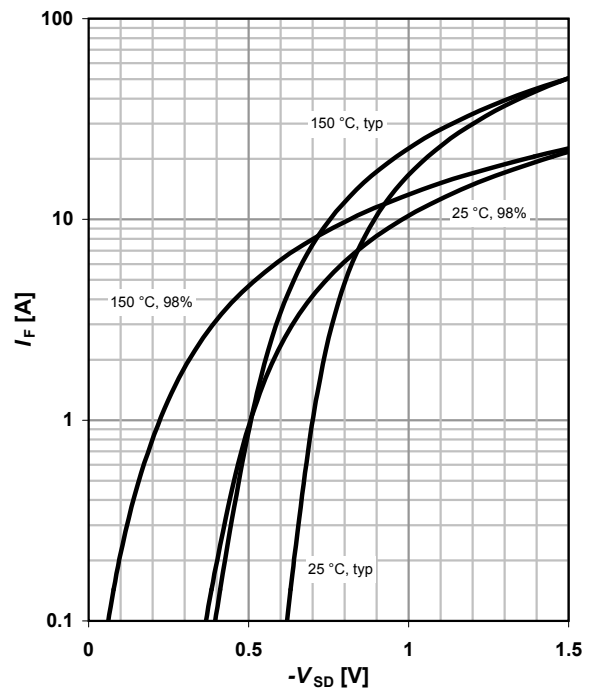

**13 Avalanche characteristics**

$I_{AS}=f(t_{AV}); R_{GS}=25 \Omega$

parameter:  $T_{j(start)}$

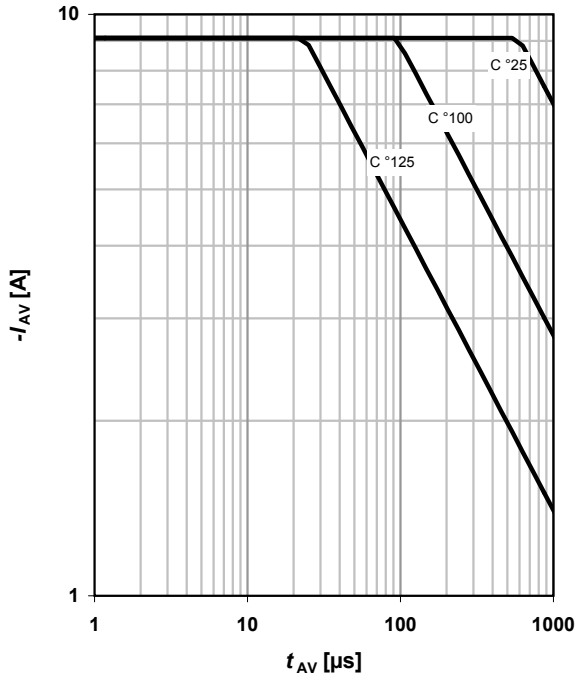

**14 Typ. gate charge**

$V_{GS}=f(Q_{gate}); I_D=-4.5 \text{ A pulsed}$

parameter:  $V_{DD}$

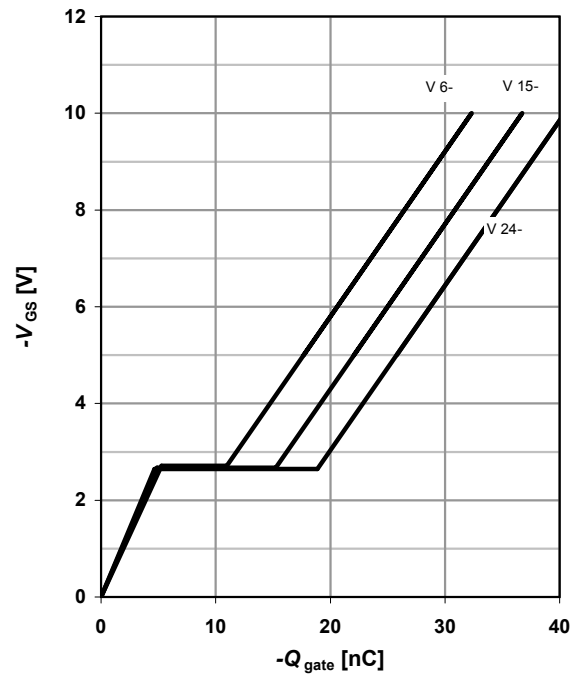

**15 Drain-source breakdown voltage**

$V_{BR(DSS)}=f(T_j); I_D=-250 \mu A$

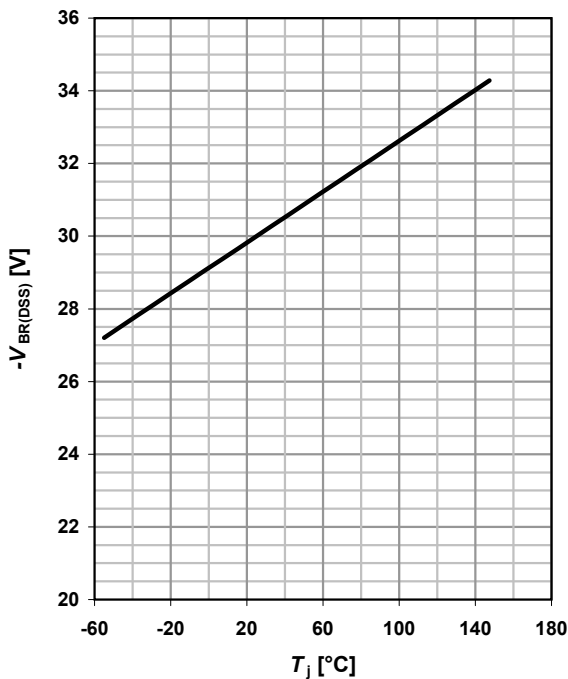

**16 Gate charge waveforms**



Package Outline

P-DSO-8: Outline

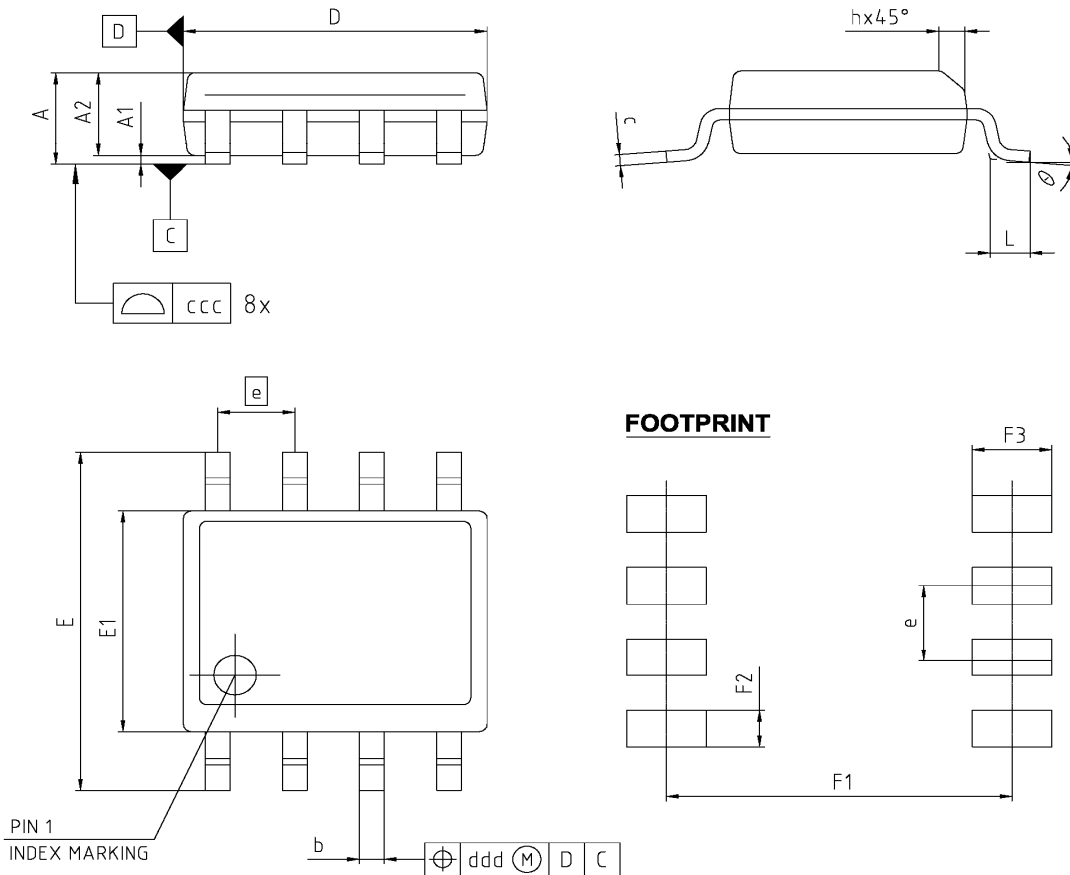

PIN 1  
INDEX MARKING

FOOTPRINT

DIM	MILLIMETERS		INCHES	
	MIN	MAX	MIN	MAX
A	-	1.750	-	0.069
A1	0.100	-	0.004	-
A2	1.250	1.650	0.049	0.065
b	0.360	0.510	0.014	0.020
c	0.190	0.250	0.007	0.010
D	4.800	5.000	0.189	0.197
E	5.800	6.200	0.228	0.244
E1	3.800	4.000	0.150	0.157
e	1.270		0.050	
N	8		8	
L	0.390	0.890	0.015	0.035
h	0.250	0.410	0.010	0.016
$\theta$	0°	8°	0°	8°
ccc	0.100		0.004	
ddd	0.200		0.008	
F1	5.590	5.790	0.220	0.228
F2	0.550	0.750	0.022	0.030
F3	1.210	1.410	0.048	0.056

REFERENCE  
JEDEC / MS-012

SCALE

EUROPEAN PROJECTION

ISSUE DATE  
19-09-2005

FILE  
DSO-8\_1

Dimensions in mm



**Published by**  
**Infineon Technologies AG**  
**81726 Munich, Germany**  
**© 2008 Infineon Technologies AG**  
**All Rights Reserved.**

**Legal Disclaimer**

The information given in this document shall in no event be regarded as a guarantee of conditions or characteristics. With respect to any examples or hints given herein, any typical values stated herein and/or any information regarding the application of the device, Infineon Technologies hereby disclaims any and all warranties and liabilities of any kind, including without limitation, warranties of non-infringement of intellectual property rights of any third party.

**Information**

For further information on technology, delivery terms and conditions and prices, please [contact the nearest Infineon Technologies Office \(www.infineon.com\)](http://www.infineon.com).

**Warnings**

Due to technical requirements, components may contain dangerous substances. For information on the types in question, please contact the nearest Infineon Technologies Office.

Infineon Technologies components may be used in life-support devices or systems only with the express written approval of Infineon Technologies, if a failure of such components can reasonably be expected to cause the failure of that life-support device or system or to affect the safety or effectiveness of that device or system. Life support devices or systems are intended to be implanted in the human body or to support and/or maintain and sustain and/or protect human life. If they fail, it is reasonable to assume that the health of the user or other persons may be endangered.