

**SIPMOS® Small-Signal Transistor**

- N channel
- Enhancement mode
- Logic Level
- Avalanche rated
- $V_{GS(th)} = 0.8 \dots 2.0 \text{ V}$
- Pb-free lead plating; RoHS compliant
- Qualified according to AEC Q101

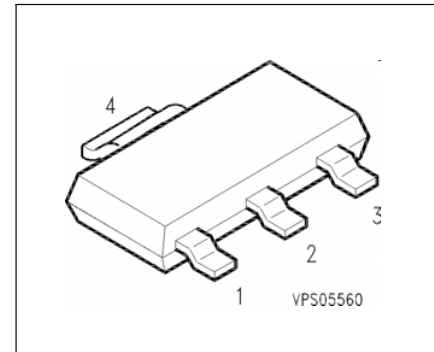
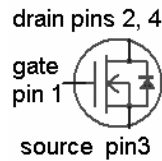

Pin 1	Pin 2	Pin 3	Pin 4
G	D	S	D

Type	$V_{DS}$	$I_D$	$R_{DS(on)}$
BSP372	100 V	1.7 A	0.31 $\Omega$

Type	Package	Tape and Reel Information	Marking	Packaging
BSP372	PG-SOT223	L6327: 1000 pcs/reel	BSP372	Non dry

**Maximum Ratings**

Parameter	Symbol	Values	Unit
Continuous drain current $T_A = 28 \text{ }^\circ\text{C}$	$I_D$	1.7	A
DC drain current, pulsed $T_A = 25 \text{ }^\circ\text{C}$	$I_{Dpuls}$	6.8	
Avalanche energy, single pulse $I_D = 1.7 \text{ A}$ , $V_{DD} = 25 \text{ V}$ , $R_{GS} = 25 \text{ } \Omega$ $L = 23.3 \text{ mH}$ , $T_j = 25 \text{ }^\circ\text{C}$	$E_{AS}$	45	mJ
Gate source voltage	$V_{GS}$	$\pm 14$	V
Gate-source peak voltage,aperiodic	$V_{gs}$	$\pm 20$	
Power dissipation $T_A = 25 \text{ }^\circ\text{C}$	$P_{tot}$	1.8	W

**Maximum Ratings**

Parameter	Symbol	Values	Unit
Chip or operating temperature	$T_j$	-55 ... + 150	°C
Storage temperature	$T_{stg}$	-55 ... + 150	
Thermal resistance, chip to ambient air <sup>1)</sup>	$R_{thJA}$	≤ 70	K/W
Thermal resistance, junction-soldering point <sup>1)</sup>	$R_{thJS}$	≤ 10	
IEC climatic category, DIN IEC 68-1		55 / 150 / 56	

1) Transistor on epoxy pcb 40 mm x 40 mm x 1,5 mm with 6 cm<sup>2</sup> copper area for drain connection

**Electrical Characteristics, at  $T_j = 25^\circ\text{C}$ , unless otherwise specified**

Parameter	Symbol	Values			Unit
		min.	typ.	max.	

**Static Characteristics**

Drain- source breakdown voltage $V_{GS} = 0\text{ V}, I_D = 0.25\text{ mA}, T_j = 0^\circ\text{C}$	$V_{(BR)DSS}$	100	-	-	V
Gate threshold voltage $V_{GS} = V_{DS}, I_D = 1\text{ mA}$	$V_{GS(th)}$	0.8	1.4	2	
Zero gate voltage drain current $V_{DS} = 100\text{ V}, V_{GS} = 0\text{ V}, T_j = 25^\circ\text{C}$ $V_{DS} = 100\text{ V}, V_{GS} = 0\text{ V}, T_j = 125^\circ\text{C}$	$I_{DSS}$	-	0.1 10	1 100	μA
Gate-source leakage current $V_{GS} = 20\text{ V}, V_{DS} = 0\text{ V}$	$I_{GSS}$	-	10	100	
Drain-Source on-state resistance $V_{GS} = 5\text{ V}, I_D = 1.7\text{ A}$	$R_{DS(on)}$	-	0.24	0.31	Ω

**Electrical Characteristics, at  $T_j = 25^\circ\text{C}$ , unless otherwise specified**

Parameter	Symbol	Values			Unit
		min.	typ.	max.	
<b>Dynamic Characteristics</b>					
Transconductance $V_{DS} \geq 2 \cdot I_D \cdot R_{DS(on)max}$ , $I_D = 1.7\text{ A}$	$g_{fs}$	2	3.7	-	S
Input capacitance $V_{GS} = 0\text{ V}$ , $V_{DS} = 25\text{ V}$ , $f = 1\text{ MHz}$	$C_{iss}$	-	415	520	pF
Output capacitance $V_{GS} = 0\text{ V}$ , $V_{DS} = 25\text{ V}$ , $f = 1\text{ MHz}$	$C_{oss}$	-	80	100	
Reverse transfer capacitance $V_{GS} = 0\text{ V}$ , $V_{DS} = 25\text{ V}$ , $f = 1\text{ MHz}$	$C_{rss}$	-	50	65	
Turn-on delay time $V_{DD} = 30\text{ V}$ , $V_{GS} = 5\text{ V}$ , $I_D = 0.3\text{ A}$ $R_G = 50\ \Omega$	$t_{d(on)}$	-	20	30	ns
Rise time $V_{DD} = 30\text{ V}$ , $V_{GS} = 5\text{ V}$ , $I_D = 0.3\text{ A}$ $R_G = 50\ \Omega$	$t_r$	-	35	55	
Turn-off delay time $V_{DD} = 30\text{ V}$ , $V_{GS} = 5\text{ V}$ , $I_D = 0.3\text{ A}$ $R_G = 50\ \Omega$	$t_{d(off)}$	-	110	165	
Fall time $V_{DD} = 30\text{ V}$ , $V_{GS} = 5\text{ V}$ , $I_D = 0.3\text{ A}$ $R_G = 50\ \Omega$	$t_f$	-	50	75	

**Electrical Characteristics**, at  $T_j = 25^\circ\text{C}$ , unless otherwise specified

Parameter	Symbol	Values			Unit
		min.	typ.	max.	
<b>Reverse Diode</b>					
Inverse diode continuous forward current $T_A = 25^\circ\text{C}$	$I_S$	-	-	1.7	A
Inverse diode direct current, pulsed $T_A = 25^\circ\text{C}$	$I_{SM}$	-	-	6.8	
Inverse diode forward voltage $V_{GS} = 0\text{ V}, I_F = 1.7\text{ A}$	$V_{SD}$	-	0.85	1.1	V
Reverse recovery time $V_R = 30\text{ V}, I_F = I_S, di_F/dt = 100\text{ A}/\mu\text{s}$	$t_{rr}$	-	65	-	ns
Reverse recovery charge $V_R = 30\text{ V}, I_F = I_S, di_F/dt = 100\text{ A}/\mu\text{s}$	$Q_{rr}$	-	0.11	-	$\mu\text{C}$

**Power dissipation**

$$P_{\text{tot}} = f(T_A)$$

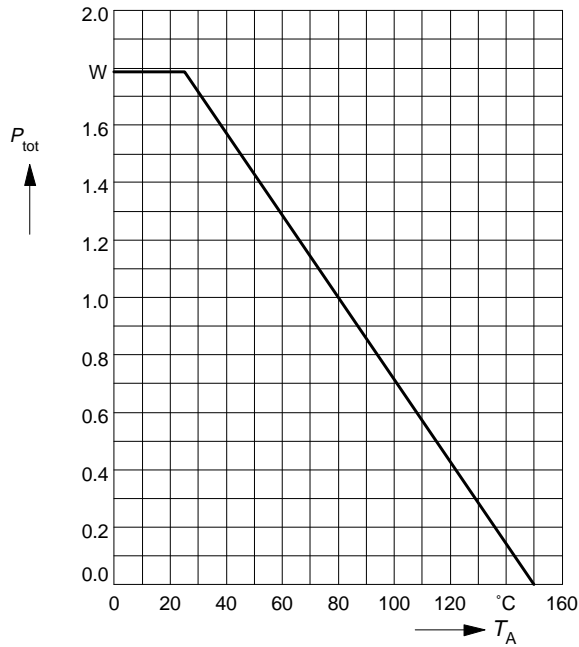

**Drain current**

$$I_D = f(T_A)$$

parameter:  $V_{GS} \geq 5 \text{ V}$

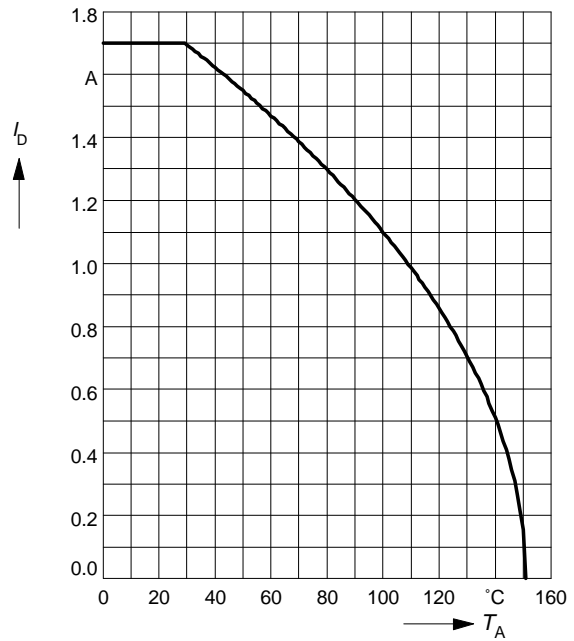

**Safe operating area  $I_D = f(V_{DS})$**

parameter:  $D = 0, T_C = 25^\circ\text{C}$

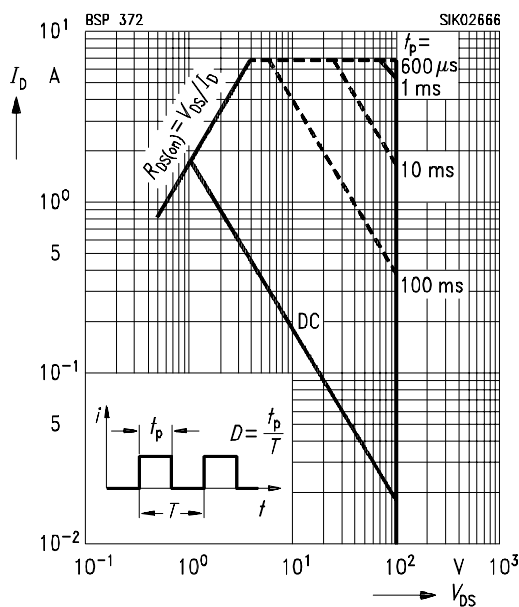

**Transient thermal impedance**

$$Z_{\text{thJA}} = f(t_p)$$

parameter:  $D = t_p / T$

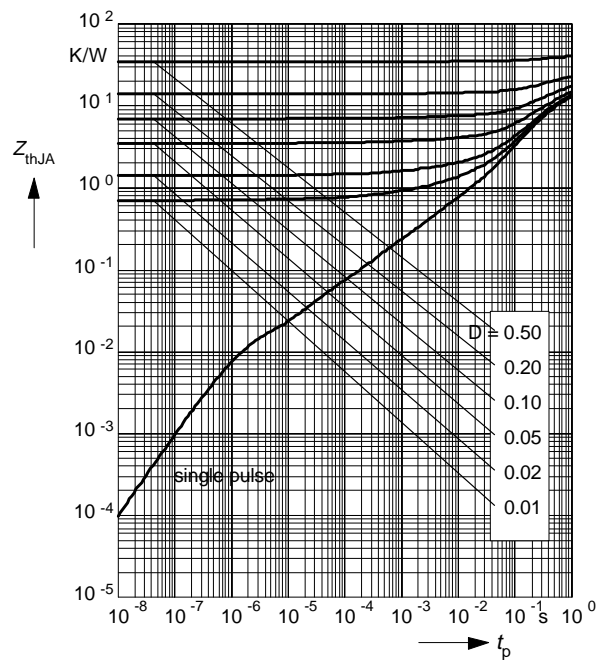

**Typ. output characteristics**

$I_D = f(V_{DS})$   
parameter:  $t_p = 80 \mu s$

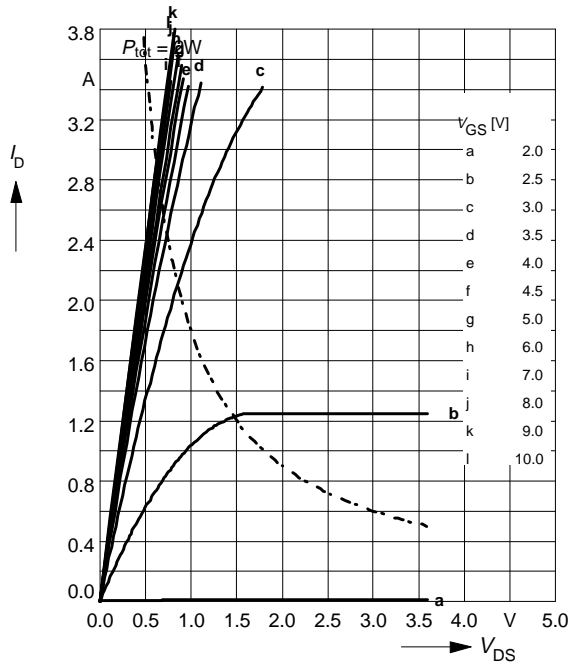

**Typ. drain-source on-resistance**

$R_{DS(on)} = f(I_D)$   
parameter:  $t_p = 80 \mu s, T_j = 25^\circ C$

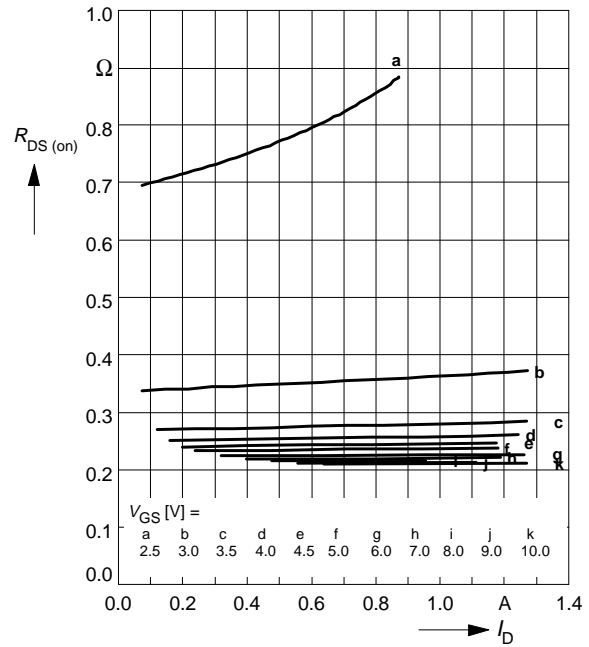

**Typ. transfer characteristics**  $I_D = f(V_{GS})$

parameter:  $t_p = 80 \mu s$   
 $V_{DS} \geq 2 \times I_D \times R_{DS(on)max}$

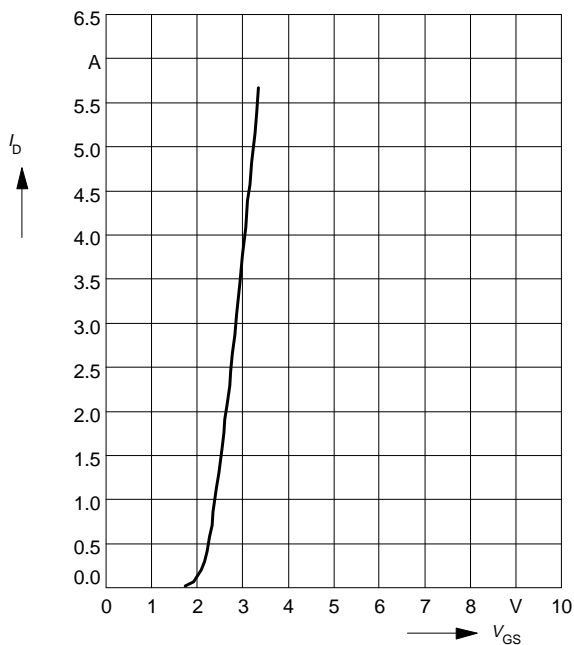

**Typ. forward transconductance**  $g_{fs} = f(I_D)$

parameter:  $t_p = 80 \mu s,$   
 $V_{DS} \geq 2 \times I_D \times R_{DS(on)max}$

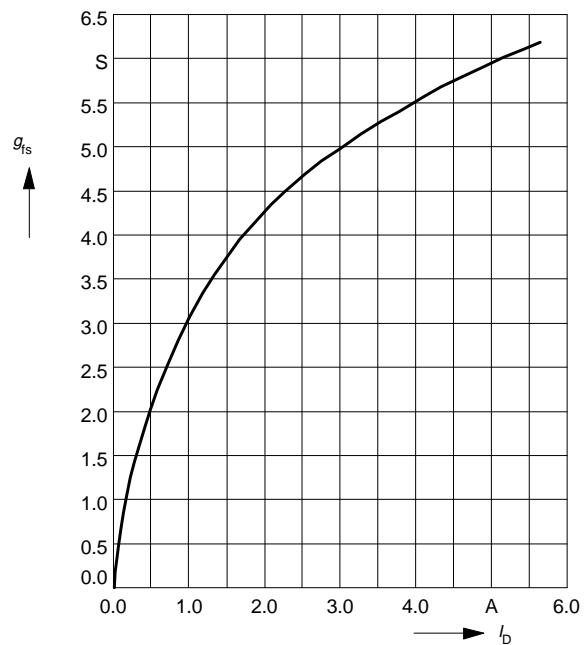

**Drain-source on-resistance**

$$R_{DS(on)} = f(T_j)$$

parameter:  $I_D = 1.7 \text{ A}$ ,  $V_{GS} = 5 \text{ V}$

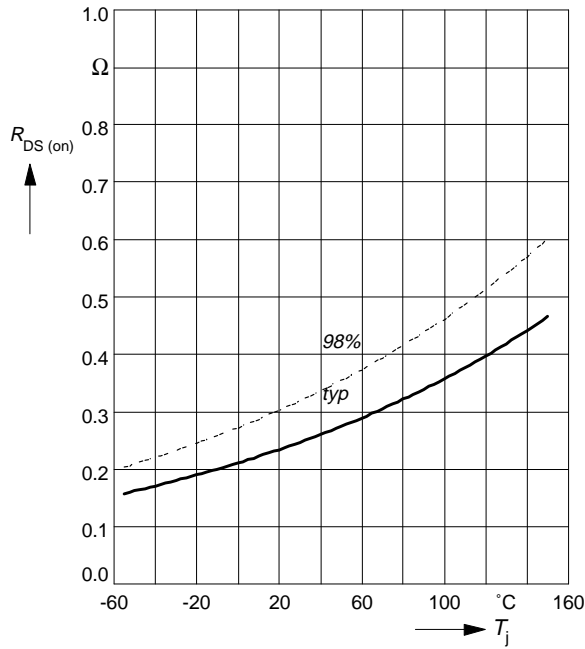

**Gate threshold voltage**

$$V_{GS(th)} = f(T_j)$$

parameter:  $V_{GS} = V_{DS}$ ,  $I_D = 1 \text{ mA}$

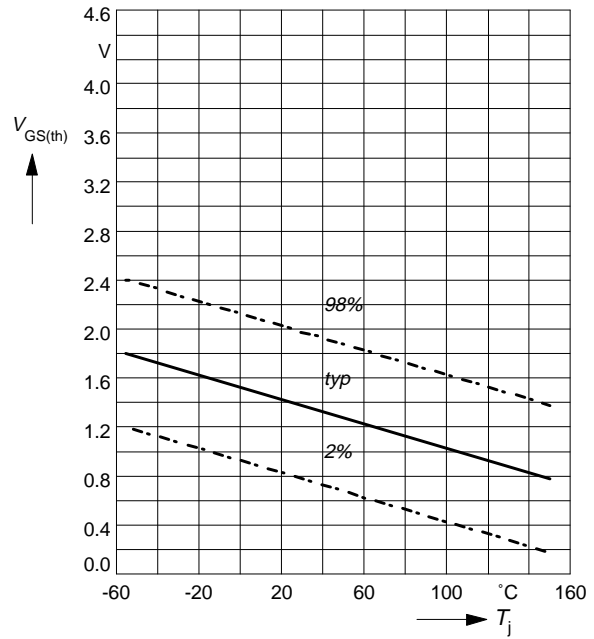

**Typ. capacitances**

$$C = f(V_{DS})$$

parameter:  $V_{GS} = 0 \text{ V}$ ,  $f = 1 \text{ MHz}$

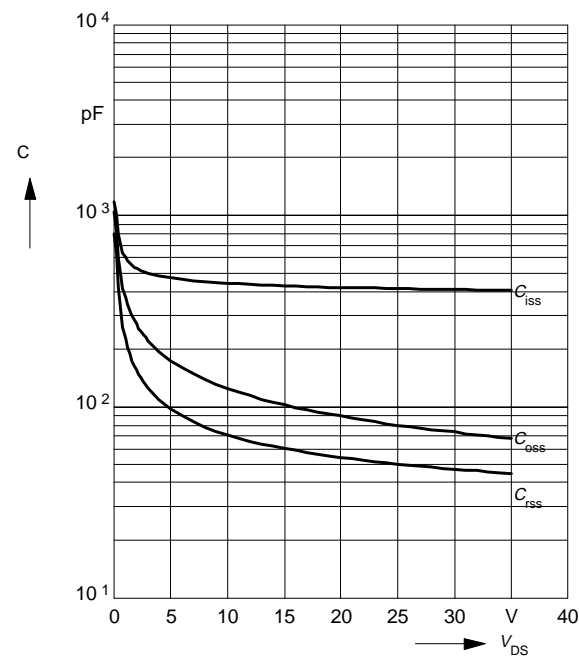

**Forward characteristics of reverse diode**

$$I_F = f(V_{SD})$$

parameter:  $T_j, t_p = 80 \mu\text{s}$

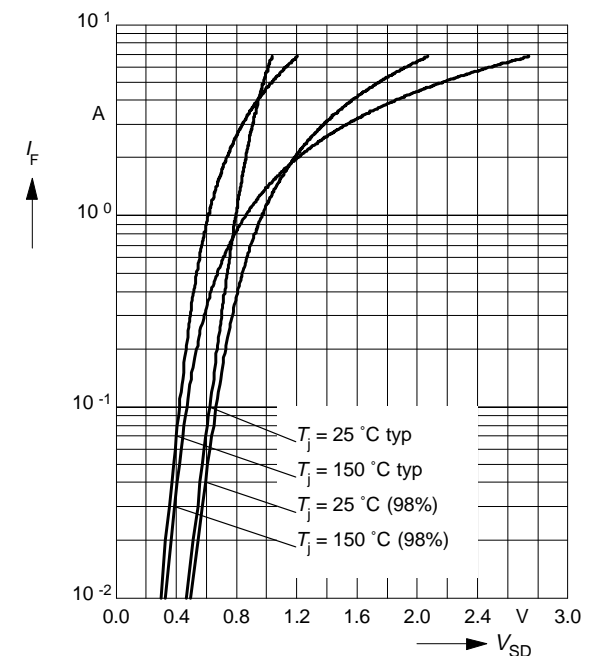

**Avalanche energy**  $E_{AS} = f(T_j)$   
 parameter:  $I_D = 1.7 \text{ A}$ ,  $V_{DD} = 25 \text{ V}$   
 $R_{GS} = 25 \text{ } \Omega$ ,  $L = 23.3 \text{ mH}$

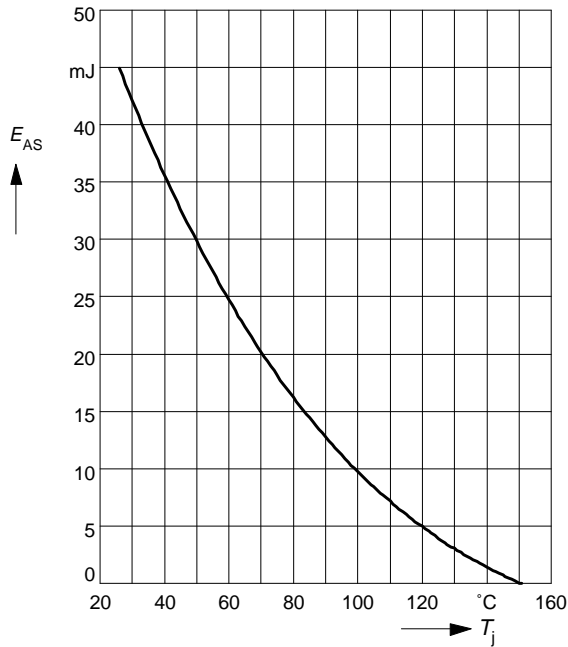

**Drain-source breakdown voltage**  
 $V_{(BR)DSS} = f(T_j)$

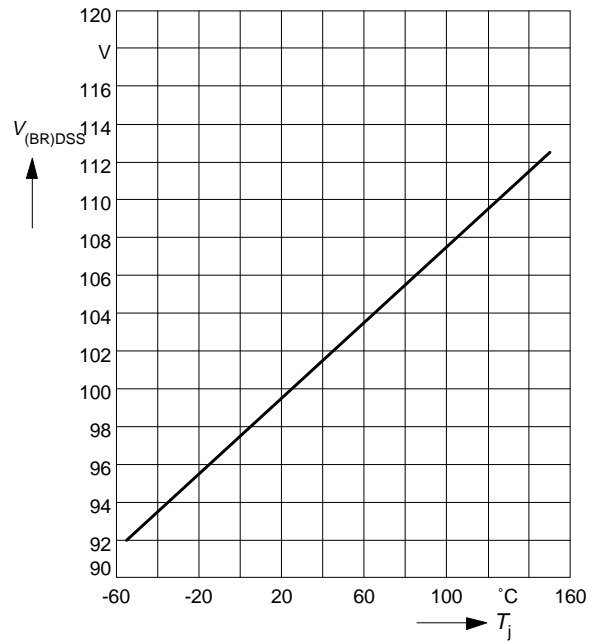

**Safe operating area**  $I_D = f(V_{DS})$   
 parameter :  $D = 0.01$ ,  $T_C = 25^\circ\text{C}$

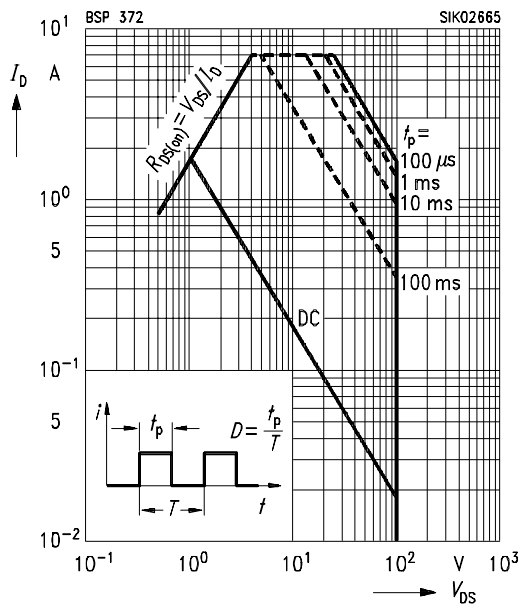



**Published by**  
**Infineon Technologies AG**  
**81726 Munich, Germany**  
**© 2008 Infineon Technologies AG**  
**All Rights Reserved.**

**Legal Disclaimer**

The information given in this document shall in no event be regarded as a guarantee of conditions or characteristics. With respect to any examples or hints given herein, any typical values stated herein and/or any information regarding the application of the device, Infineon Technologies hereby disclaims any and all warranties and liabilities of any kind, including without limitation, warranties of non-infringement of intellectual property rights of any third party.

**Information**

For further information on technology, delivery terms and conditions and prices, please contact the nearest Infineon Technologies Office ([www.infineon.com](http://www.infineon.com)).

**Warnings**

Due to technical requirements, components may contain dangerous substances. For information on the types in question, please contact the nearest Infineon Technologies Office. Infineon Technologies components may be used in life-support devices or systems only with the express written approval of Infineon Technologies, if a failure of such components can reasonably be expected to cause the failure of that life-support device or system or to affect the safety or effectiveness of that device or system. Life support devices or systems are intended to be implanted in the human body or to support and/or maintain and sustain and/or protect human life. If they fail, it is reasonable to assume that the health of the user or other persons may be endangered.