



**AO4406**

**N-Channel Enhancement Mode Field Effect Transistor**



**General Description**

The AO4406/L uses advanced trench technology to provide excellent  $R_{DS(ON)}$ , low gate charge and operation with gate voltages as low as 2.5V. This device makes an excellent high side switch for notebook CPU core DC-DC conversion. *AO4406 and AO4406L are electrically identical.*

- RoHS Compliant
- AO4406L is Halogen Free

**Features**

- $V_{DS}$  (V) = 30V
- $I_D$  = 11.5A ( $V_{GS}$  = 10V)
- $R_{DS(ON)} < 14m\Omega$  ( $V_{GS}$  = 10V)
- $R_{DS(ON)} < 16.5m\Omega$  ( $V_{GS}$  = 4.5V)
- $R_{DS(ON)} < 26m\Omega$  ( $V_{GS}$  = 2.5V)

**UIS TESTED!**  
**Rg,Ciss,Coss,Crss Tested**

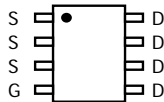

**SOIC-8**

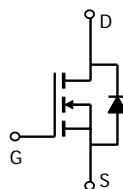

**Absolute Maximum Ratings  $T_A=25^\circ\text{C}$  unless otherwise noted**

Parameter	Symbol	Maximum	Units
Drain-Source Voltage	$V_{DS}$	30	V
Gate-Source Voltage	$V_{GS}$	$\pm 12$	V
Continuous Drain Current <sup>AF</sup>	$I_D$	11.5	A
		$T_A=25^\circ\text{C}$	
	$T_A=70^\circ\text{C}$	9.6	
Pulsed Drain Current <sup>B</sup>	$I_{DM}$	80	
Avalanche Current <sup>B</sup>	$I_{AV}$	25	A
Repetitive Avalanche Energy <sup>B</sup> $L=0.3\text{mH}$	$E_{AV}$	94	mJ
Power Dissipation	$P_D$	$T_A=25^\circ\text{C}$	3
		$T_A=70^\circ\text{C}$	2.1
Junction and Storage Temperature Range	$T_J, T_{STG}$	-55 to 150	$^\circ\text{C}$

**Thermal Characteristics**

Parameter	Symbol	Typ	Max	Units
Maximum Junction-to-Ambient <sup>AF</sup>	$R_{\theta JA}$	$t \leq 10\text{s}$	23	$^\circ\text{C/W}$
Maximum Junction-to-Ambient <sup>A</sup>		Steady-State	48	$^\circ\text{C/W}$
Maximum Junction-to-Lead <sup>C</sup>	$R_{\theta JL}$	12	16	$^\circ\text{C/W}$

Electrical Characteristics (T<sub>J</sub>=25°C unless otherwise noted)

Symbol	Parameter	Conditions	Min	Typ	Max	Units
<b>STATIC PARAMETERS</b>						
BV <sub>DSS</sub>	Drain-Source Breakdown Voltage	I <sub>D</sub> =250μA, V <sub>GS</sub> =0V	30			V
I <sub>DSS</sub>	Zero Gate Voltage Drain Current	V <sub>DS</sub> =30V, V <sub>GS</sub> =0V T <sub>J</sub> =55°C			1 5	μA
I <sub>GSS</sub>	Gate-Body leakage current	V <sub>DS</sub> =0V, V <sub>GS</sub> =±12V			100	nA
V <sub>GS(th)</sub>	Gate Threshold Voltage	V <sub>DS</sub> =V <sub>GS</sub> , I <sub>D</sub> =250μA	0.8	1	1.5	V
I <sub>D(ON)</sub>	On state drain current	V <sub>GS</sub> =4.5V, V <sub>DS</sub> =5V	60			A
R <sub>DS(ON)</sub>	Static Drain-Source On-Resistance	V <sub>GS</sub> =10V, I <sub>D</sub> =12A T <sub>J</sub> =125°C		11.5	14	mΩ
		V <sub>GS</sub> =4.5V, I <sub>D</sub> =10A		13.5	16.5	mΩ
		V <sub>GS</sub> =2.5V, I <sub>D</sub> =8A		19.5	26	mΩ
g <sub>FS</sub>	Forward Transconductance	V <sub>DS</sub> =5V, I <sub>D</sub> =10A	25	38		S
V <sub>SD</sub>	Diode Forward Voltage	I <sub>S</sub> =10A, V <sub>GS</sub> =0V		0.83	1	V
I <sub>S</sub>	Maximum Body-Diode Continuous Current				4.5	A
<b>DYNAMIC PARAMETERS</b>						
C <sub>iss</sub>	Input Capacitance	V <sub>GS</sub> =0V, V <sub>DS</sub> =15V, f=1MHz		1630	2300	pF
C <sub>oss</sub>	Output Capacitance			201		pF
C <sub>rss</sub>	Reverse Transfer Capacitance			142	200	pF
R <sub>g</sub>	Gate resistance	V <sub>GS</sub> =0V, V <sub>DS</sub> =0V, f=1MHz	0.4	0.8	1.8	Ω
<b>SWITCHING PARAMETERS</b>						
Q <sub>g</sub>	Total Gate Charge	V <sub>GS</sub> =4.5V, V <sub>DS</sub> =15V, I <sub>D</sub> =11.5A	13.5	18	24	nC
Q <sub>gs</sub>	Gate Source Charge			2.5		nC
Q <sub>gd</sub>	Gate Drain Charge			5.5		nC
t <sub>D(on)</sub>	Turn-On Delay Time	V <sub>GS</sub> =10V, V <sub>DS</sub> =15V, R <sub>L</sub> =1.2Ω, R <sub>GEN</sub> =3Ω		4	6	ns
t <sub>r</sub>	Turn-On Rise Time			5	7.5	ns
t <sub>D(off)</sub>	Turn-Off Delay Time			32	50	ns
t <sub>f</sub>	Turn-Off Fall Time			5	10	ns
t <sub>rr</sub>	Body Diode Reverse Recovery Time	I <sub>F</sub> =10A, dI/dt=100A/μs		18.7	24	ns
Q <sub>rr</sub>	Body Diode Reverse Recovery Charge	I <sub>F</sub> =10A, dI/dt=100A/μs		12.5	15	nC

A: The value of R<sub>θJA</sub> is measured with the device mounted on 1in 2 FR-4 board with 2oz. Copper, in a still air environment with T<sub>A</sub>=25°C. The value in any given application depends on the user's specific board design.

B: Repetitive rating, pulse width limited by junction temperature.

C: The R<sub>θJA</sub> is the sum of the thermal impedance from junction to lead R<sub>θJL</sub> and lead to ambient.

D: The static characteristics in Figures 1 to 6 are obtained using <300μs pulses, duty cycle 0.5% max.

E: These tests are performed with the device mounted on 1in 2 FR-4 board with 2oz. Copper, in a still air environment with T<sub>A</sub>=25°C. The SOA curve provides a single pulse rating.

F: The current rating is based on the ≤ 10s junction to ambient thermal resistance rating.

Rev8: July 2008

THIS PRODUCT HAS BEEN DESIGNED AND QUALIFIED FOR THE CONSUMER MARKET. APPLICATIONS OR USES AS CRITICAL COMPONENTS IN LIFE SUPPORT DEVICES OR SYSTEMS ARE NOT AUTHORIZED. AOS DOES NOT ASSUME ANY LIABILITY ARISING OUT OF SUCH APPLICATIONS OR USES OF ITS PRODUCTS. AOS RESERVES THE RIGHT TO IMPROVE PRODUCT DESIGN, FUNCTIONS AND RELIABILITY WITHOUT NOTICE.

TYPICAL ELECTRICAL AND THERMAL CHARACTERISTICS

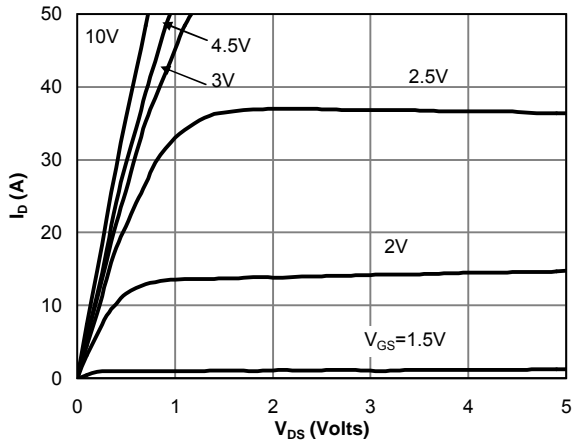

Fig 1: On-Region Characteristics

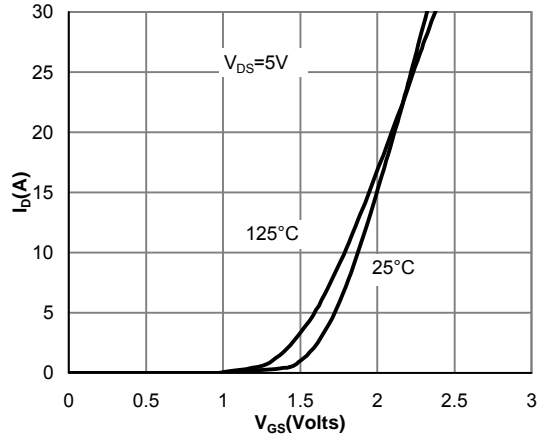

Figure 2: Transfer Characteristics

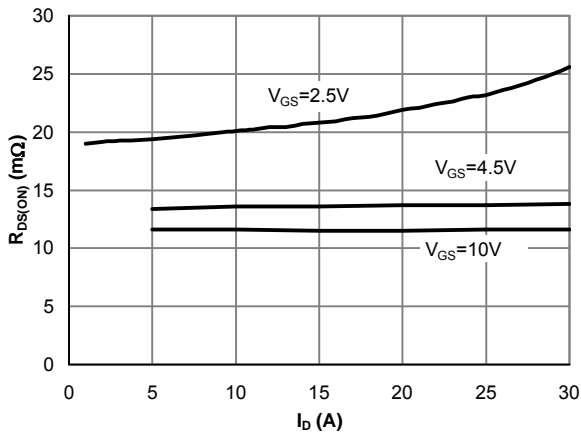

Figure 3: On-Resistance vs. Drain Current and Gate Voltage

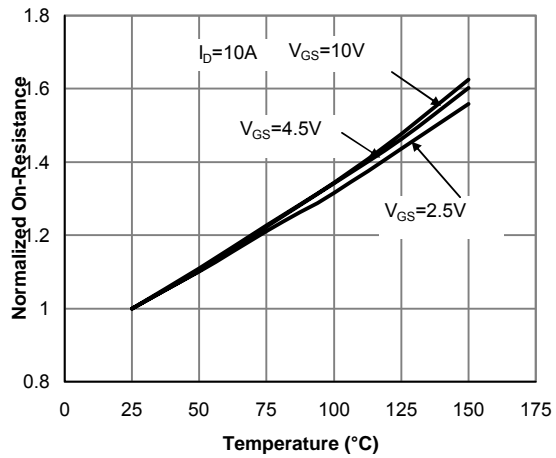

Figure 4: On-Resistance vs. Junction Temperature

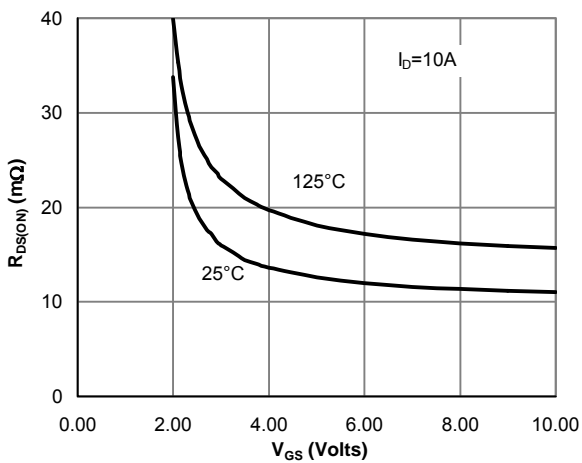

Figure 5: On-Resistance vs. Gate-Source Voltage

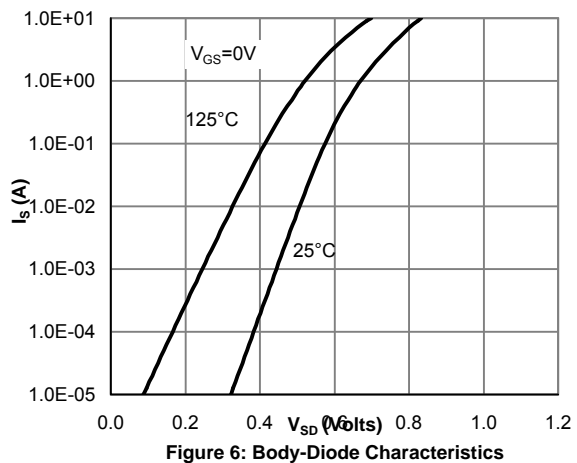

Figure 6: Body-Diode Characteristics

TYPICAL ELECTRICAL AND THERMAL CHARACTERISTICS

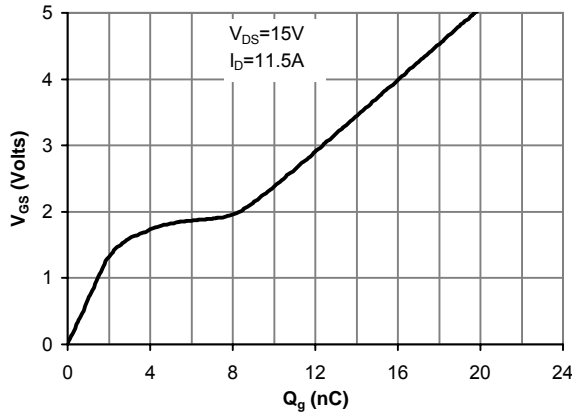

Figure 7: Gate-Charge Characteristics

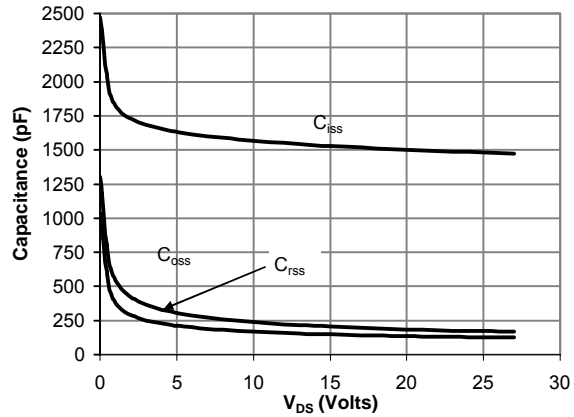

Figure 8: Capacitance Characteristics

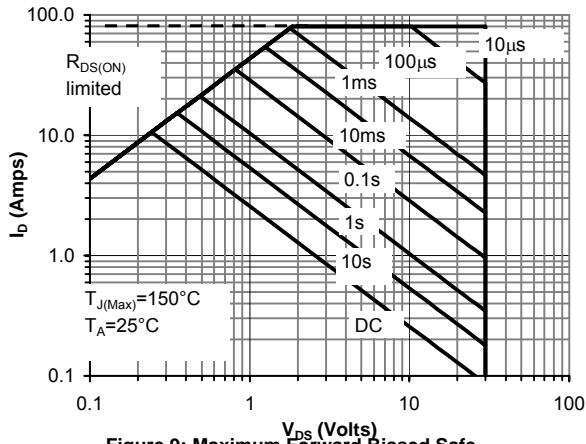

Figure 9: Maximum Forward Biased Safe Operating Area (Note E)

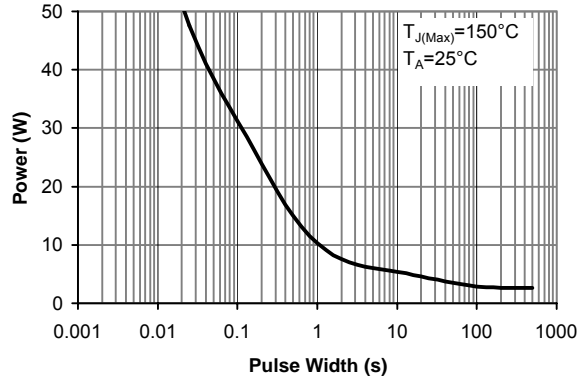

Figure 10: Single Pulse Power Rating Junction-to-Ambient (Note E)

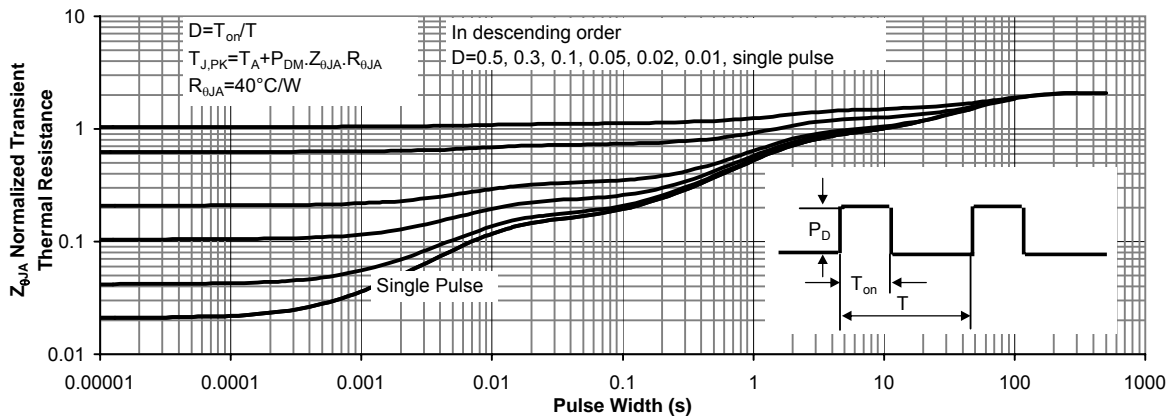
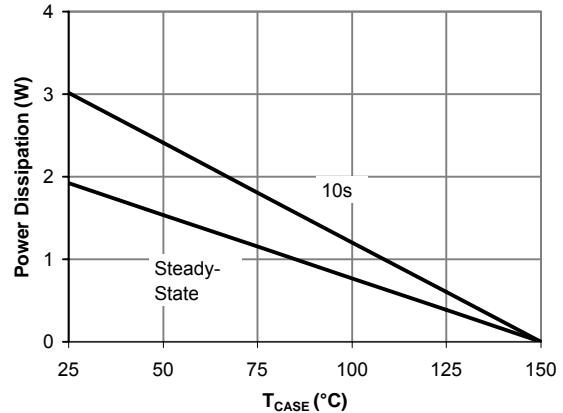
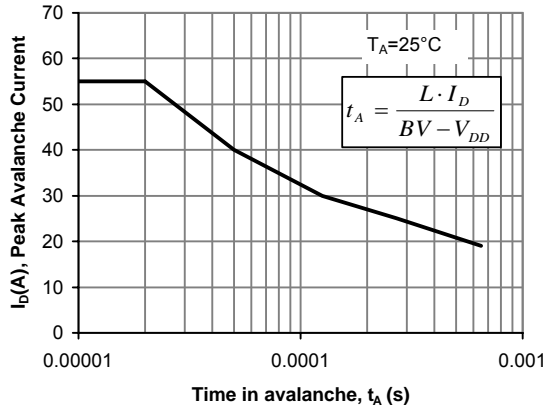
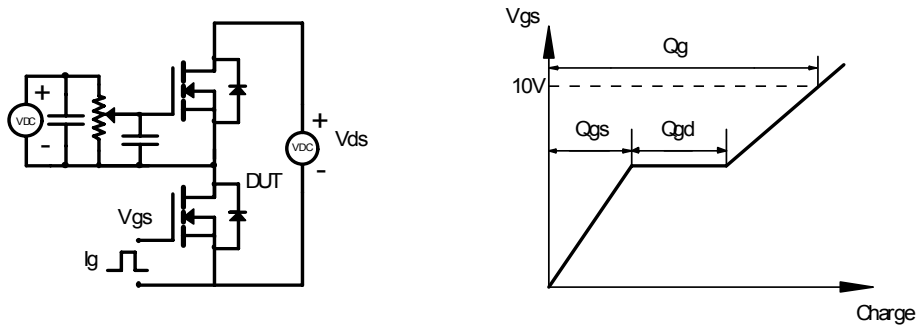

Figure 11: Normalized Maximum Transient Thermal Impedance

TYPICAL ELECTRICAL AND THERMAL CHARACTERISTICS



Gate Charge Test Circuit & Waveform



Resistive Switching Test Circuit & Waveforms

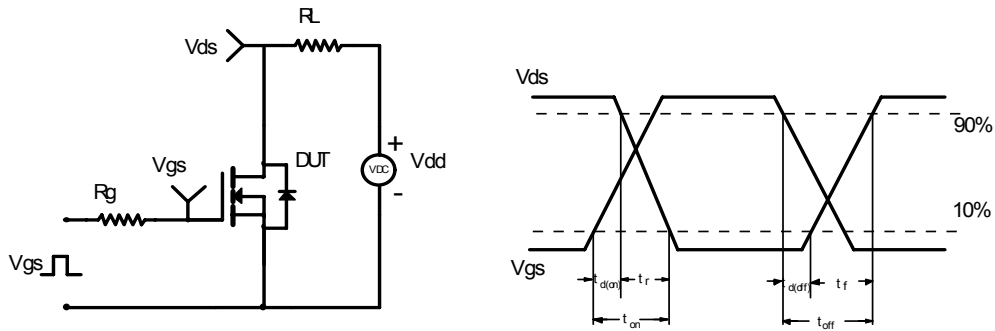

Unclamped Inductive Switching (UIS) Test Circuit & Waveforms

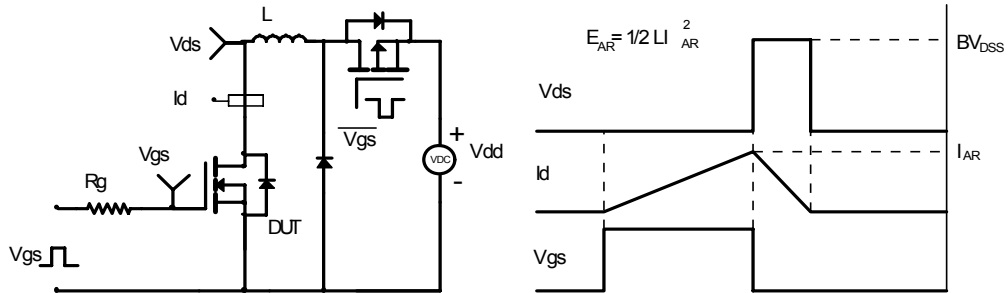

Diode Recovery Test Circuit & Waveforms

