

Polar™ Power MOSFET IXFB300N10P

HiPerFET™

N-Channel Enhancement Mode
Avalanche Rated
Fast Intrinsic Diode

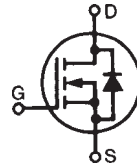

$$V_{DSS} = 100V$$

$$I_{D25} = 300A$$

$$R_{DS(on)} \leq 5.5m\Omega$$

$$t_{rr} \leq 200ns$$

PLUS264™ (IXFB)

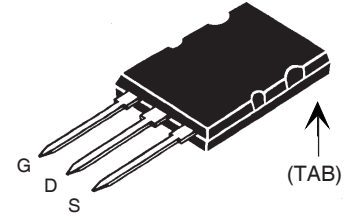

G = Gate D = Drain
S = Source TAB = Drain

Symbol	Test Conditions	Maximum Ratings	
V_{DSS}	$T_J = 25^\circ C$ to $175^\circ C$	100	V
V_{DGR}	$T_J = 25^\circ C$ to $175^\circ C$, $R_{GS} = 1M\Omega$	100	V
V_{GSS}	Continuous	± 20	V
V_{GSM}	Transient	± 30	V
I_{D25}	$T_C = 25^\circ C$	300	A
I_{LRMS}	Leads Current Limit, RMS	75	A
I_{DM}	$T_C = 25^\circ C$, pulse width limited by T_{JM}	900	A
I_A	$T_C = 25^\circ C$	100	A
E_{AS}	$T_C = 25^\circ C$	3	J
dV/dt	$I_S \leq I_{DM}$, $V_{DD} \leq V_{DSS}$, $T_J \leq 175^\circ C$	20	V/ns
P_D	$T_C = 25^\circ C$	1500	W
T_J		-55 ... +175	$^\circ C$
T_{JM}		175	$^\circ C$
T_{stg}		-55 ... +175	$^\circ C$
T_L	1.6mm (0.062 in.) from case for 10s	300	$^\circ C$
T_{SOLD}	Plastic body for 10s	260	$^\circ C$
F_C	Mounting force	30..120/6.7..27	N/lb.
Weight		10	g

Features

- Fast intrinsic diode
- Avalanche Rated
- Low $R_{DS(ON)}$ and Q_G
- Low package inductance

Advantages

- Easy to mount
- Space savings
- High power density
- Low gate drive requirement

Applications

- DC-DC converters
- Battery chargers
- Switched-mode and resonant-mode power supplies
- DC choppers
- AC and DC motor drives
- Uninterrupted power supplies
- High speed power switching applications

Symbol	Test Conditions	Characteristic Values		
		Min.	Typ.	Max.
BV_{DSS}	$V_{GS} = 0V$, $I_D = 3mA$	100		V
$V_{GS(th)}$	$V_{DS} = V_{GS}$, $I_D = 8mA$	3.0		5.0 V
I_{GSS}	$V_{GS} = \pm 20V$, $V_{DS} = 0V$			± 200 nA
I_{DSS}	$V_{DS} = V_{DSS}$ $V_{GS} = 0V$			25 μA 1.5 mA
$R_{DS(on)}$	$V_{GS} = 10V$, $I_D = 50A$, Note 1			5.5 m Ω

Symbol	Test Conditions	Characteristic Values		
		Min.	Typ.	Max.
g_{fs}	$V_{DS} = 10V, I_D = 60A$, Note 1	55	92	S
C_{iss}	$V_{GS} = 0V, V_{DS} = 25V, f = 1MHz$		23	nF
C_{oss}			6100	pF
C_{rss}			417	pF
$t_{d(on)}$	Resistive Switching Times $V_{GS} = 10V, V_{DS} = 0.5 \cdot V_{DSS}, I_D = 100A$ $R_G = 1\Omega$ (External)		36	ns
t_r			35	ns
$t_{d(off)}$			56	ns
t_f			25	ns
$Q_{g(on)}$	$V_{GS} = 10V, V_{DS} = 0.5 \cdot V_{DSS}, I_D = 0.5 \cdot I_{D25}$		279	nC
Q_{gs}			84	nC
Q_{gd}			107	nC
R_{thJC}			0.10	$^{\circ}C/W$
R_{thCS}		0.13		$^{\circ}C/W$

Source-Drain Diode

Symbol	Test Conditions	Characteristic Values		
		Min.	Typ.	Max.
I_S	$V_{GS} = 0V$			300 A
I_{SM}	Repetitive, pulse width limited by T_{JM}			1000 A
V_{SD}	$I_F = 100A, V_{GS} = 0V$, Note 1			1.3 V
t_{rr}	$I_F = 150A, -di/dt = 100A/\mu s$ $V_R = 50V$		0.71	200 ns
Q_{RM}				μC
I_{RM}			10	A

Note 1: Pulse test, $t \leq 300\mu s$; duty cycle, $d \leq 2\%$.

PLUS264™ (IXFB) Outline

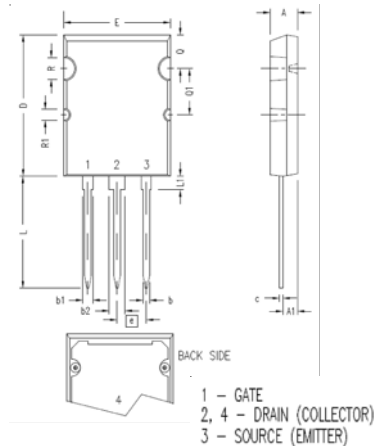

SYM	INCHES		MILLIMETERS	
	MIN	MAX	MIN	MAX
A	.185	.209	4.70	5.31
A1	.102	.118	2.59	3.00
b	.037	.055	0.94	1.40
b1	.087	.102	2.21	2.59
b2	.110	.126	2.79	3.20
c	.017	.029	0.43	0.74
D	1.007	1.047	25.58	26.59
E	.760	.799	19.30	20.29
e	.215 BSC		5.46 BSC	
L	.779	.842	19.79	21.39
L1	.087	.102	2.21	2.59
Q	.240	.256	6.10	6.50
Q1	.330	.346	8.38	8.79
$\varnothing R$.155	.187	3.94	4.75
$\varnothing R1$.085	.093	2.16	2.36

PRELIMINARY TECHNICAL INFORMATION

The product presented herein is under development. The Technical Specifications offered are derived from data gathered during objective characterizations of preliminary engineering lots; but also may yet contain some information supplied during a pre-production design evaluation. IXYS reserves the right to change limits, test conditions, and dimensions without notice.

IXYS reserves the right to change limits, test conditions, and dimensions.

IXYS MOSFETs and IGBTs are covered by one or more of the following U.S. patents:	4,835,592	4,931,844	5,049,961	5,237,481	6,162,665	6,404,065 B1	6,683,344	6,727,585	7,005,734 B2	7,157,338B2
	4,850,072	5,017,508	5,063,307	5,381,025	6,259,123 B1	6,534,343	6,710,405 B2	6,759,692	7,063,975 B2	
	4,881,106	5,034,796	5,187,117	5,486,715	6,306,728 B1	6,583,505	6,710,463	6,771,478 B2	7,071,537	

Fig. 1. Extended Output Characteristics @ 25°C

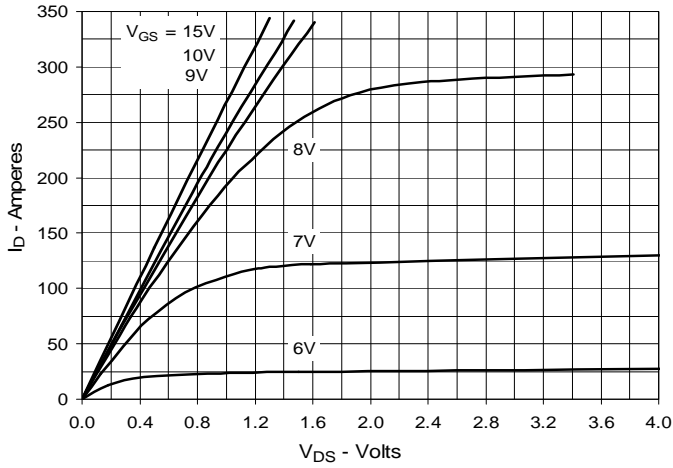

Fig. 2. Output Characteristics @ 150°C

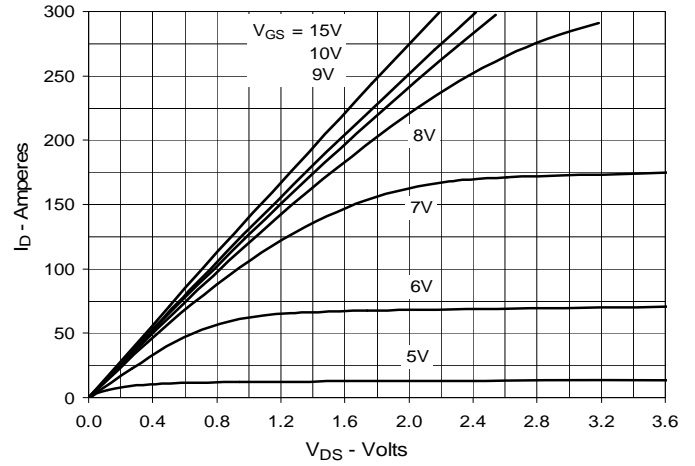

Fig. 3. $R_{DS(on)}$ Normalized to $I_D = 150A$ Value vs. Junction Temperature

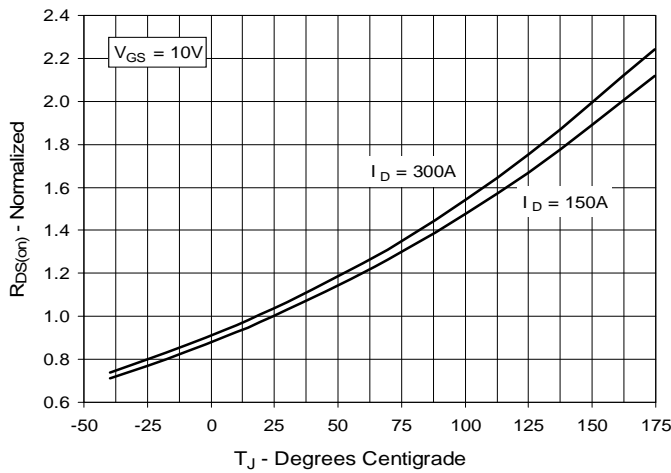

Fig. 4. $R_{DS(on)}$ Normalized to $I_D = 150A$ Value vs. Drain Current

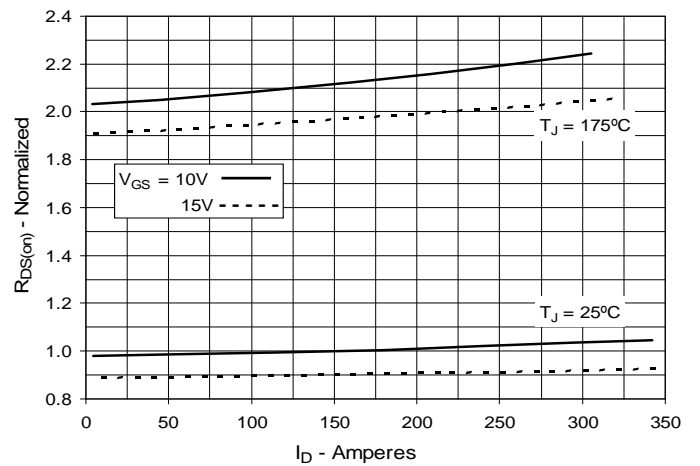

Fig. 5. Maximum Drain Current vs. Case Temperature

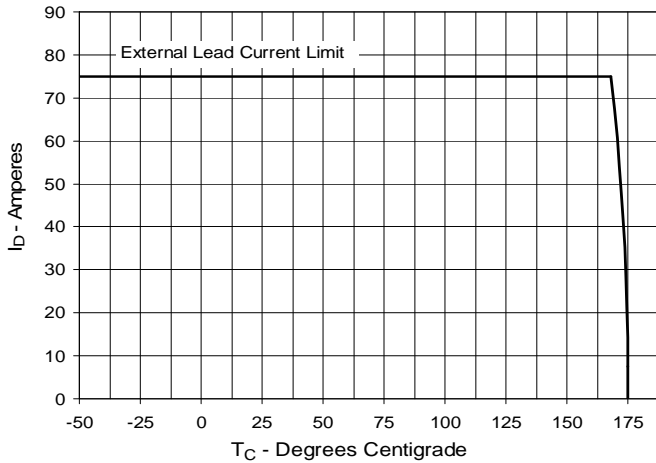

Fig. 6. Input Admittance

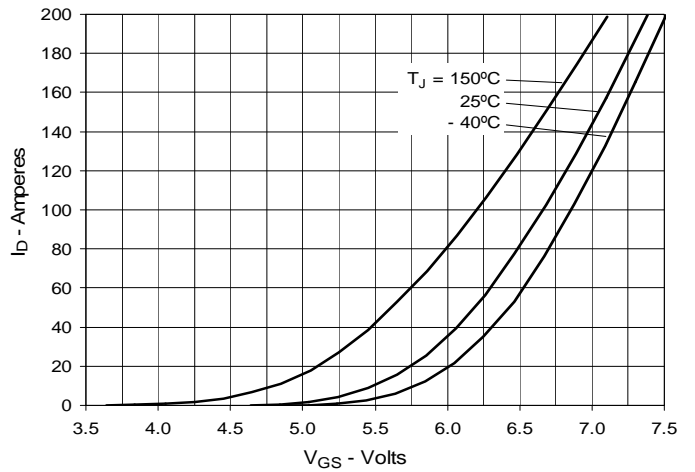

Fig. . Transconductance

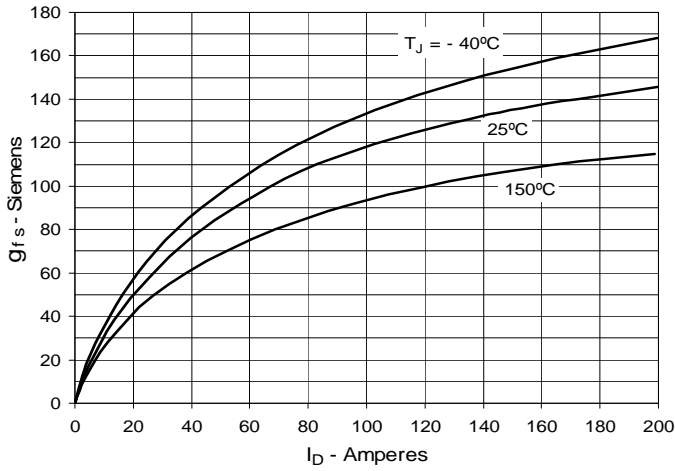

Fig. 8. Forward Voltage Drop of Intrinsic Diode

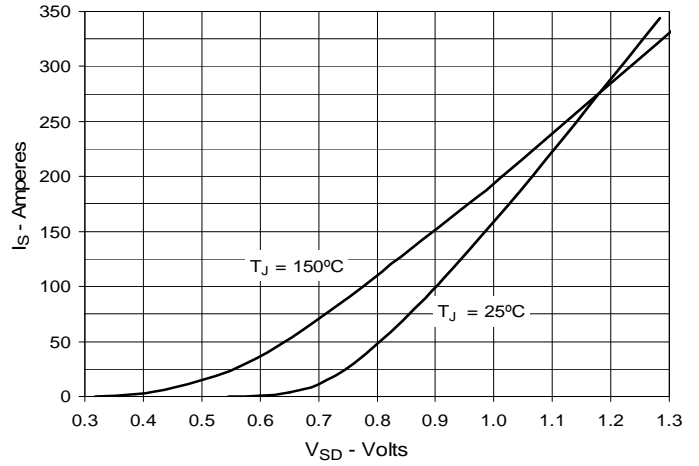

Fig. 9. Gate Charge

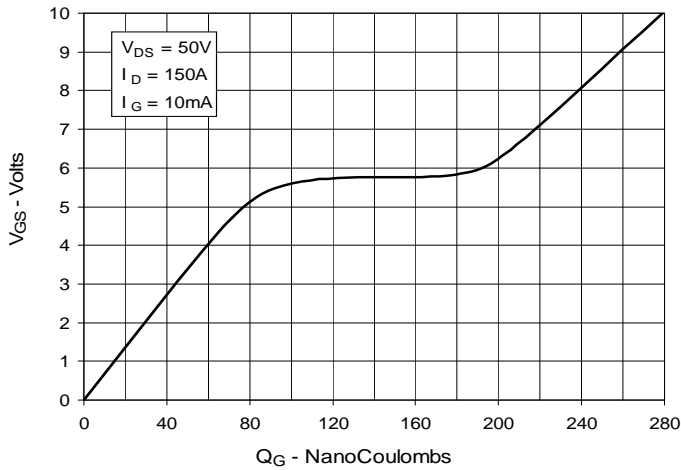

Fig. 10. Capacitance

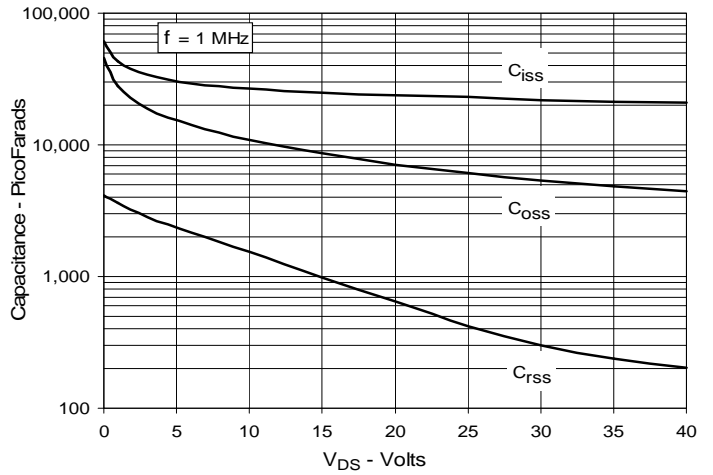

Fig. 11. Forward-Bias Safe Operating Area

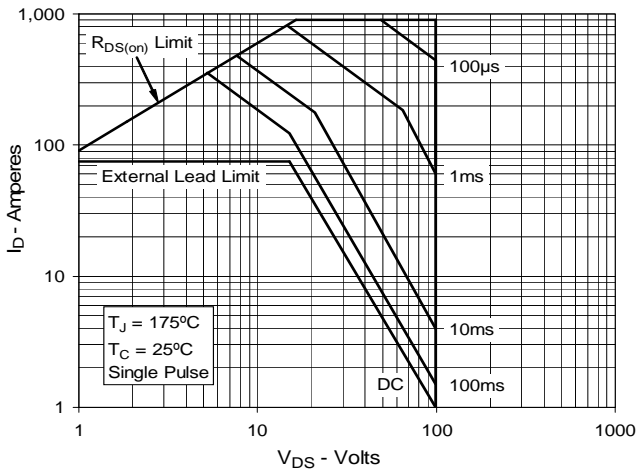
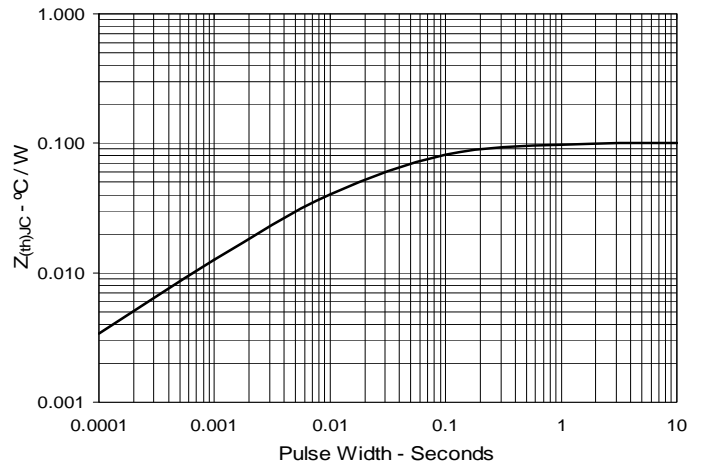

Fig. 12. Maximum Transient Thermal Impedance



IXYS reserves the right to change limits, test conditions, and dimensions.