



STB12NM50ND STD12NM50ND, STF12NM50ND

N-channel 500 V, 0.29 Ω , 11 A, FDmesh™ II Power MOSFET
(with fast diode) in D²PAK, DPAK, TO-220FP

Features

Type	V _{DSS} (@T _{jmax})	R _{DS(on)} max	I _D
STB12NM50ND	550 V	0.38 Ω	11 A
STD12NM50ND	550 V	0.38 Ω	11 A
STF12NM50ND	550 V	0.38 Ω	11 A

- 100% avalanche tested
- Low input capacitance and gate charge
- Low gate input resistance

Application

- Switching applications

Description

FDmesh™ technology combines the MDmesh™ features with an intrinsic fast-recovery body diode. The resulting product has reduced on-resistance and fast switching commutations, making it especially suitable for bridge topologies where low t_{rr} is required.

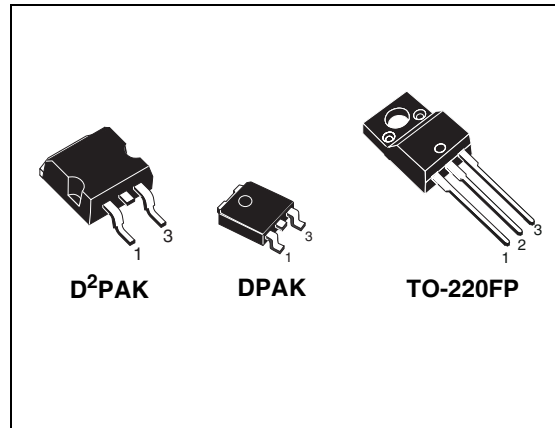

Figure 1. Internal schematic diagram

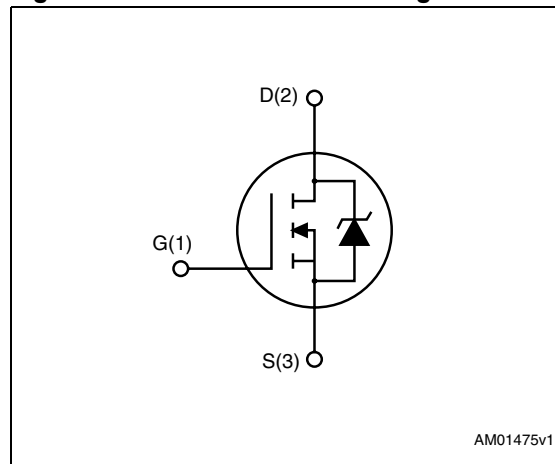

Table 1. Device summary

Order codes	Marking	Package	Packaging
STB12NM50ND	12NM50ND	D ² PAK	Tape and reel
STD12NM50ND	12NM50ND	DPAK	Tape and reel
STF12NM50ND	12NM50ND	TO-220FP	Tube

Contents

1	Electrical ratings	3
2	Electrical characteristics	4
	2.1 Electrical characteristics (curves)	6
3	Test circuits	9
4	Package mechanical data	10
5	Packaging mechanical data	13
6	Revision history	15

1 Electrical ratings

Table 2. Absolute maximum ratings

Symbol	Parameter	Value			Unit
		D ² PAK	DPAK	TO-220FP	
V _{DS}	Drain-source voltage (V _{GS} =0)	500			V
V _{GS}	Gate-source voltage	± 25			V
I _D	Drain current (continuous) at T _C = 25 °C	11		11 ⁽¹⁾	A
I _D	Drain current (continuous) at T _C = 100 °C	6.9		6.9 ⁽¹⁾	A
I _{DM} ⁽²⁾	Drain current (pulsed)	44		44 ⁽¹⁾	A
P _{TOT}	Total dissipation at T _C = 25 °C	100		25	W
V _{ISO}	Insulation withstand voltage (RMS) from all three leads to external heat sink (t=1 s; T _C =25 °C)			2500	V
dv/dt ⁽³⁾	Peak diode recovery voltage slope	40			V/ns
T _{stg}	Storage temperature	-55 to 150			°C
T _j	Operating junction temperature	150			°C

- Limited only by maximum temperature allowed
- Pulse width limited by safe operating area
- $I_{SD} \leq 11$ A, $di/dt \leq 600$ A/ μ s, $V_{DD} = 80\% V_{(BR)DSS}$

Table 3. Thermal data

Symbol	Parameter	Value			Unit
		D ² PAK	DPAK	TO-220FP	
R _{thj-case}	Thermal resistance junction-case max	1.25		5	°C/W
R _{thj-pcb}	Thermal resistance junction-pcb max	30	50		°C/W
R _{thj-amb}	Thermal resistance junction-amb max			62.5	°C/W
T _l	Maximum lead temperature for soldering purposes	300			°C

Table 4. Avalanche characteristics

Symbol	Parameter	Max value	Unit
I _{AS}	Avalanche current, repetitive or not-repetitive (pulse width limited by T _j max)	5	A
E _{AS}	Single pulse avalanche energy (starting T _j = 25 °C, I _D = I _{AS} , V _{DD} = 50 V)	350	mJ

2 Electrical characteristics

($T_{CASE} = 25\text{ °C}$ unless otherwise specified)

Table 5. On/off states

Symbol	Parameter	Test conditions	Min.	Typ.	Max.	Unit
$V_{(BR)DSS}$	Drain-source breakdown voltage	$I_D = 1\text{ mA}$, $V_{GS} = 0$	500			V
$dv/dt^{(1)}$	Drain-source voltage slope	$V_{DD} = 400\text{ V}$, $I_D = 11\text{ A}$, $V_{GS} = 10\text{ V}$	44			V/ns
I_{DSS}	Zero gate voltage drain current ($V_{GS} = 0$)	$V_{DS} = \text{Max rating}$, $V_{DS} = \text{Max rating}$, @ 125 °C			1 100	μA μA
I_{GSS}	Gate body leakage current ($V_{DS} = 0$)	$V_{GS} = \pm 20\text{ V}$			100	nA
$V_{GS(th)}$	Gate threshold voltage	$V_{DS} = V_{GS}$, $I_D = 250\text{ }\mu\text{A}$	3	4	5	V
$R_{DS(on)}$	Static drain-source on resistance	$V_{GS} = 10\text{ V}$, $I_D = 5.5\text{ A}$		0.29	0.38	Ω

1. Value measured at turn off under inductive load

Table 6. Dynamic

Symbol	Parameter	Test conditions	Min.	Typ.	Max.	Unit
$g_{fs}^{(1)}$	Forward transconductance	$V_{DS} = 15\text{ V}$, $I_D = 5.5\text{ A}$	-	8	-	S
C_{iss}	Input capacitance	$V_{DS} = 50\text{ V}$, $f = 1\text{ MHz}$, $V_{GS} = 0$	-	850	-	pF
C_{oss}	Output capacitance			48		pF
C_{rss}	Reverse transfer capacitance			5		pF
$C_{oss\text{ eq.}}^{(2)}$	Equivalent output capacitance	$V_{GS} = 0$, $V_{DS} = 0\text{ to }400\text{ V}$	-	100	-	pF
R_g	Gate input resistance	$f = 1\text{ MHz}$ Gate DC Bias=0 Test signal level=20 mV open drain	-	4.5	-	Ω
Q_g	Total gate charge	$V_{DD} = 400\text{ V}$, $I_D = 11\text{ A}$	-	30	-	nC
Q_{gs}	Gate-source charge	$V_{GS} = 10\text{ V}$		6		nC
Q_{gd}	Gate-drain charge	Figure 19		17		nC

1. Pulsed: pulse duration = 300 μs , duty cycle 1.5%

2. $C_{oss\text{ eq.}}$ is defined as a constant equivalent capacitance giving the same charging time as C_{oss} when V_{DS} increases from 0 to 80% V_{DSS}

Table 7. Switching times

Symbol	Parameter	Test conditions	Min.	Typ.	Max.	Unit
$t_{d(on)}$	Turn-on delay time	$V_{DD} = 250\text{ V}$, $I_D = 5.5\text{ A}$, $R_G = 4.7\ \Omega$, $V_{GS} = 10\text{ V}$ <i>Figure 18</i>		12		ns
t_r	Rise time		-	15	-	ns
$t_{d(off)}$	Turn-off delay time			40		ns
t_f	Fall time			17		ns

Table 8. Source drain diode

Symbol	Parameter	Test conditions	Min.	Typ.	Max.	Unit
I_{SD}	Source-drain current				11	A
$I_{SDM}^{(1)}$	Source-drain current (pulsed)		-		44	A
$V_{SD}^{(2)}$	Forward on voltage	$I_{SD} = 11\text{ A}$, $V_{GS} = 0$	-		1.6	V
t_{rr}	Reverse recovery time	$I_{SD} = 11\text{ A}$, $di/dt = 100\text{ A}/\mu\text{s}$, $V_{DD} = 100\text{ V}$ <i>Figure 20</i>		122		ns
Q_{rr}	Reverse recovery charge		-	650		nC
I_{RRM}	Reverse recovery current			11		A
t_{rr}	Reverse recovery time	$V_{DD} = 100\text{ V}$ $di/dt = 100\text{ A}/\mu\text{s}$, $I_{SD} = 11\text{ A}$ $T_j = 150\text{ }^\circ\text{C}$, <i>Figure 20</i>		160		ns
Q_{rr}	Reverse recovery charge		-	940		nC
I_{RRM}	Reverse recovery current			12		A

1. Pulse width limited by safe operating area

2. Pulsed: pulse duration = 300 μs , duty cycle 1.5%

2.1 Electrical characteristics (curves)

Figure 2. Safe operating area for D²PAK

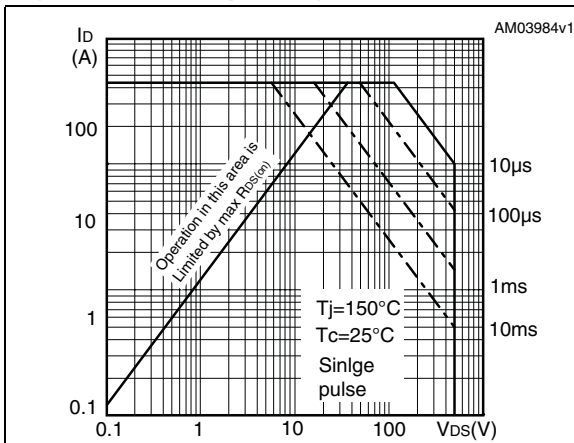

Figure 3. Thermal impedance for D²PAK

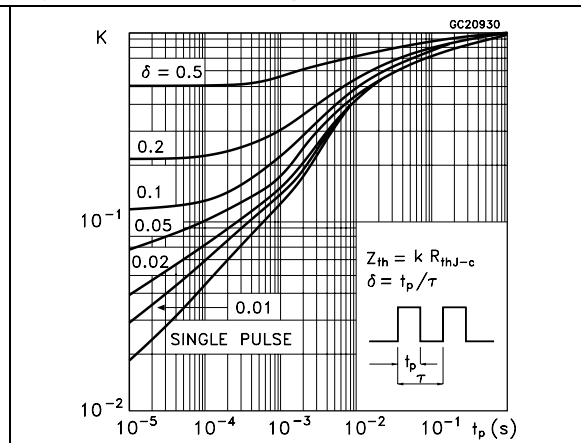

Figure 4. Safe operating area for TO-220FP

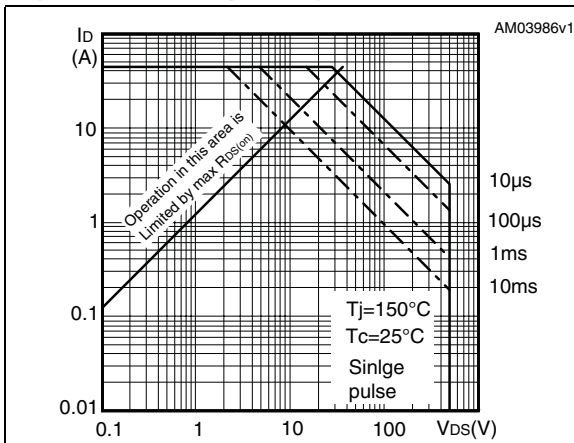

Figure 5. Thermal impedance for TO-220FP

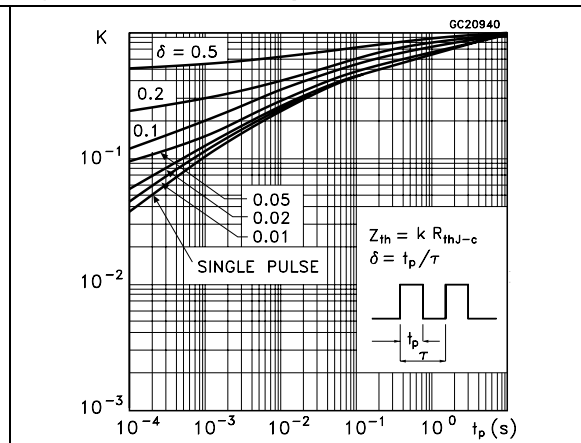

Figure 6. Safe operating area for DPAK

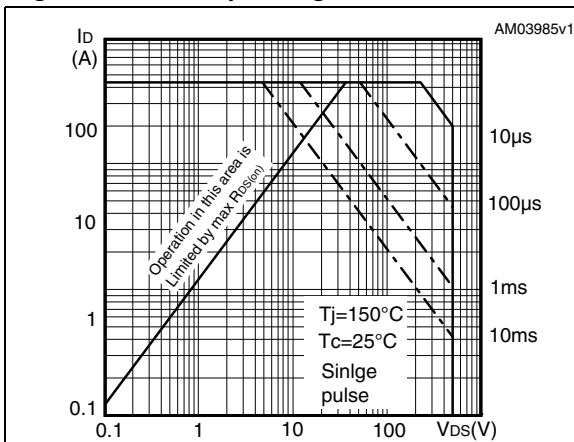

Figure 7. Thermal impedance for DPAK

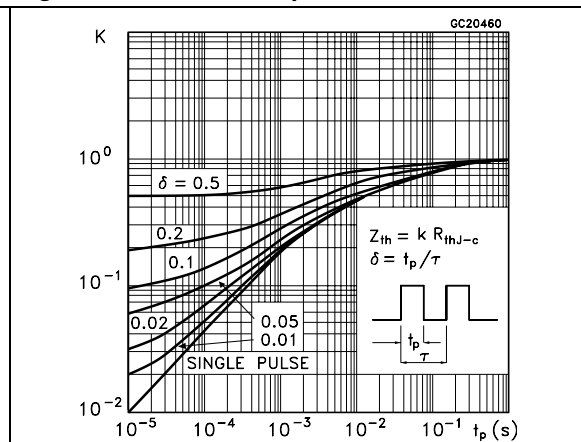

Figure 8. Output characteristics

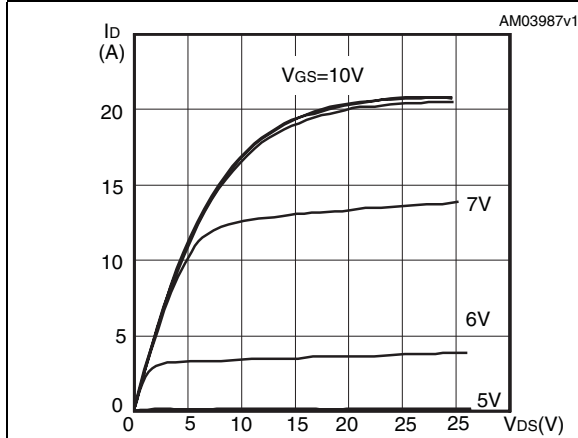

Figure 9. Transfer characteristics

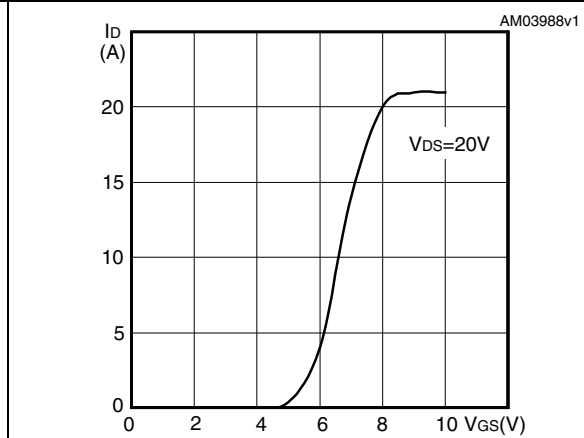

Figure 10. Transconductance

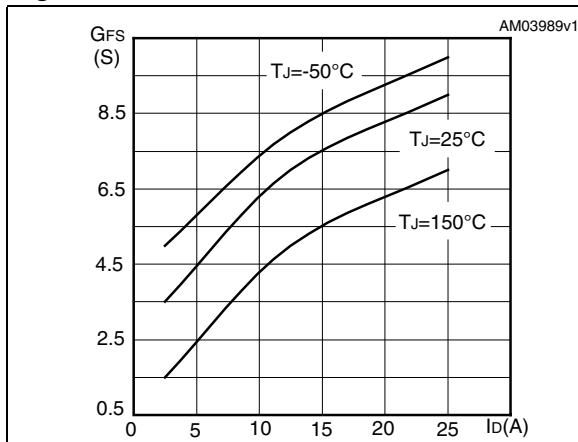

Figure 11. Static drain-source on resistance

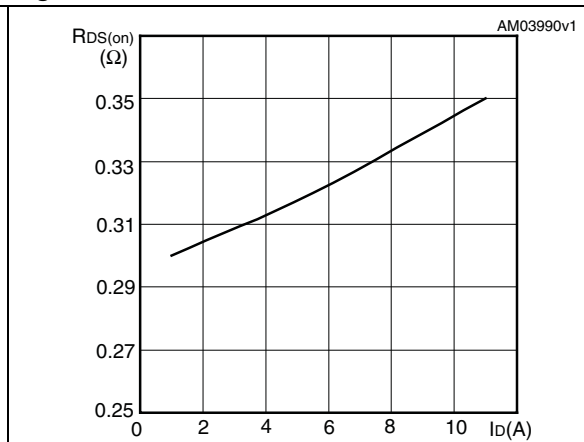

Figure 12. Gate charge vs gate-source voltage Figure 13. Capacitance variations

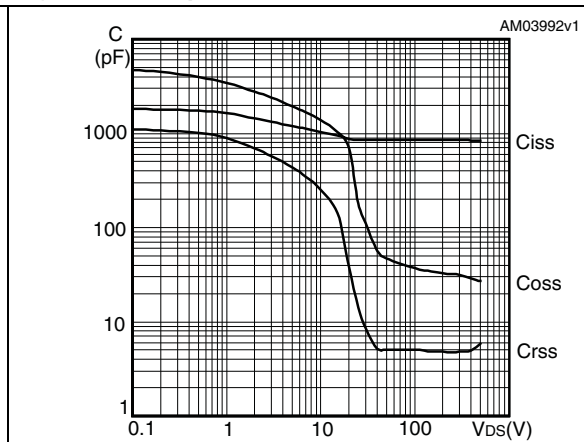
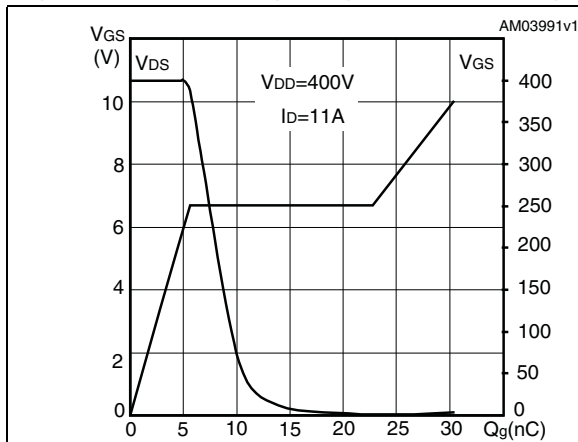

Figure 14. Normalized gate threshold voltage vs temperature

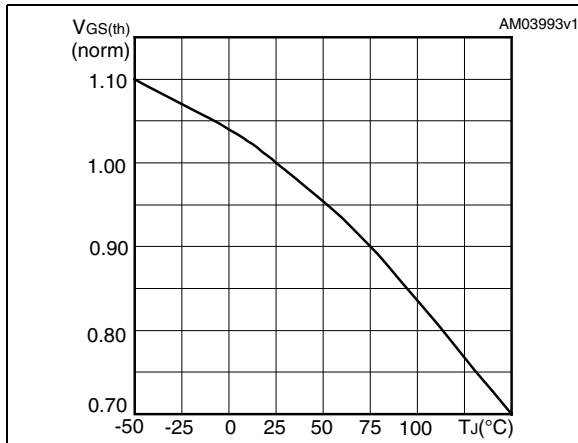

Figure 15. Normalized on resistance vs temperature

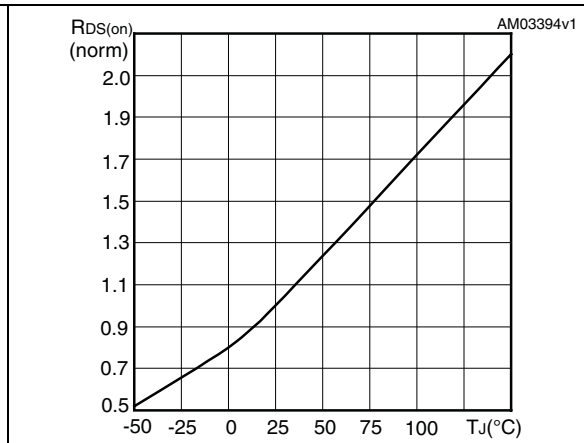

Figure 16. Source-drain diode forward characteristics

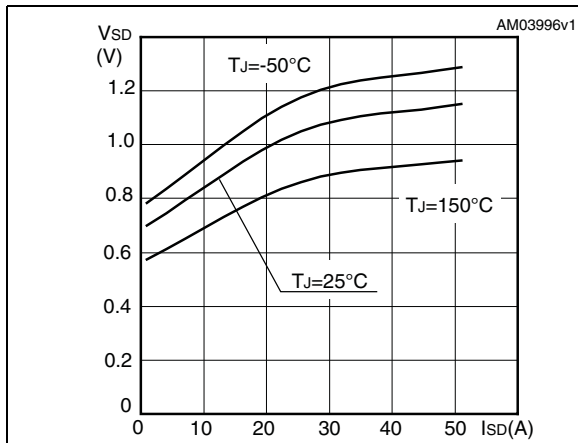
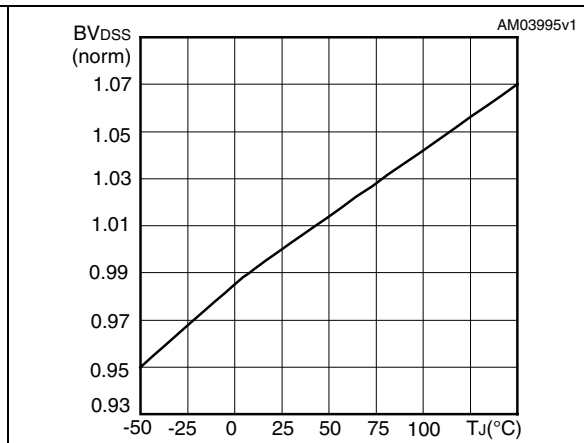

Figure 17. Normalized B_VDSS vs temperature



3 Test circuits

Figure 18. Switching times test circuit for resistive load

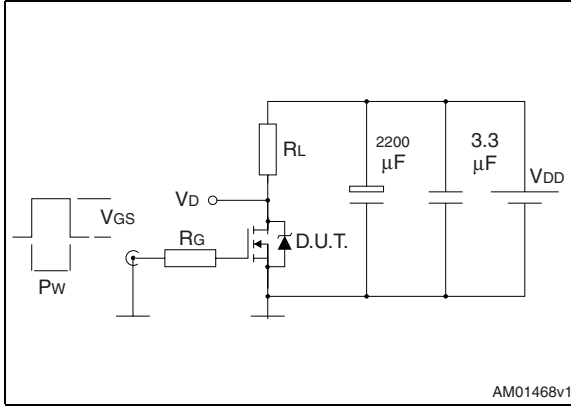

Figure 19. Gate charge test circuit

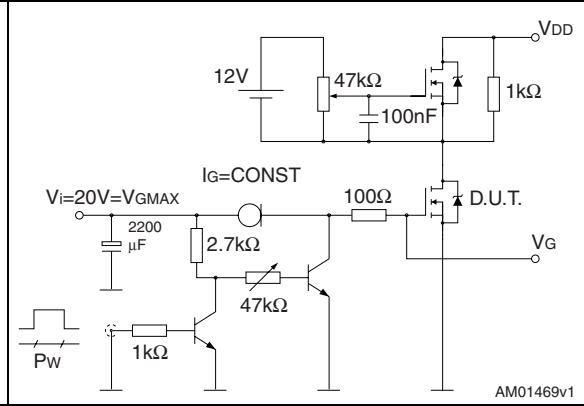

Figure 20. Test circuit for inductive load switching and diode recovery times

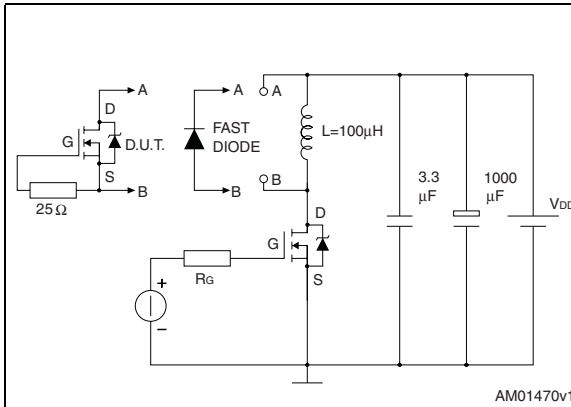

Figure 21. Unclamped inductive load test circuit

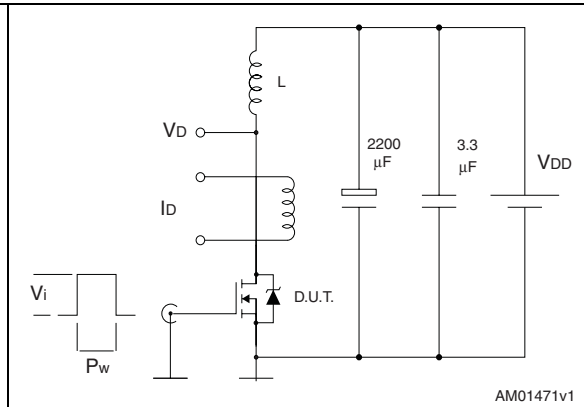

Figure 22. Unclamped inductive waveform

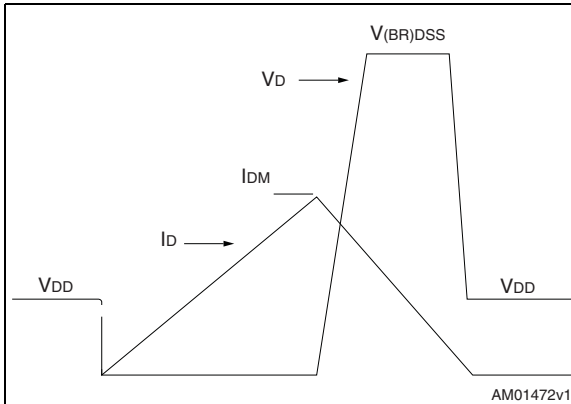
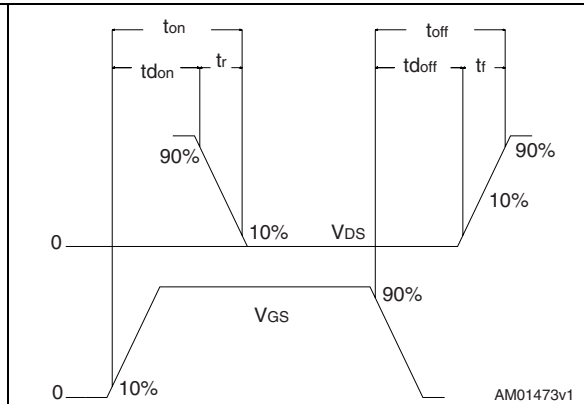

Figure 23. Switching time waveform



4 Package mechanical data

In order to meet environmental requirements, ST offers these devices in different grades of ECOPACK[®] packages, depending on their level of environmental compliance. ECOPACK[®] specifications, grade definitions and product status are available at: www.st.com. ECOPACK is an ST trademark.

TO-252 (DPAK) mechanical data

DIM.	mm.		
	min.	typ	max.
A	2.20		2.40
A1	0.90		1.10
A2	0.03		0.23
b	0.64		0.90
b4	5.20		5.40
c	0.45		0.60
c2	0.48		0.60
D	6.00		6.20
D1		5.10	
E	6.40		6.60
E1		4.70	
e		2.28	
e1	4.40		4.60
H	9.35		10.10
L	1		
L1		2.80	
L2		0.80	
L4	0.60		1
R		0.20	
V2	0°		8°

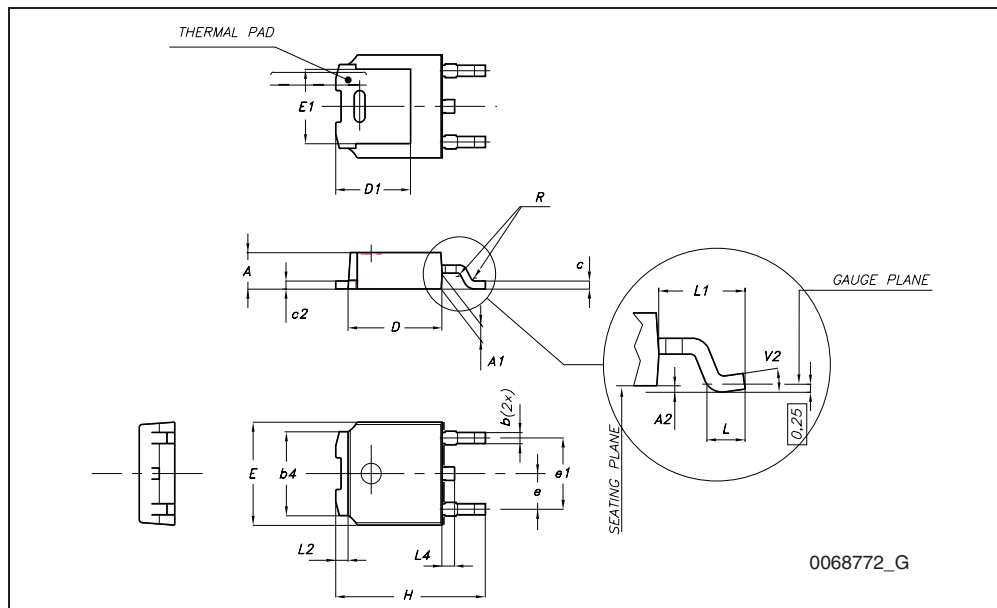

D²PAK (TO-263) mechanical data

Dim	mm			inch		
	Min	Typ	Max	Min	Typ	Max
A	4.40		4.60	0.173		0.181
A1	0.03		0.23	0.001		0.009
b	0.70		0.93	0.027		0.037
b2	1.14		1.70	0.045		0.067
c	0.45		0.60	0.017		0.024
c2	1.23		1.36	0.048		0.053
D	8.95		9.35	0.352		0.368
D1	7.50			0.295		
E	10		10.40	0.394		0.409
E1	8.50			0.334		
e		2.54			0.1	
e1	4.88		5.28	0.192		0.208
H	15		15.85	0.590		0.624
J1	2.49		2.69	0.099		0.106
L	2.29		2.79	0.090		0.110
L1	1.27		1.40	0.05		0.055
L2	1.30		1.75	0.051		0.069
R		0.4			0.016	
V2	0°		8°	0°		8°

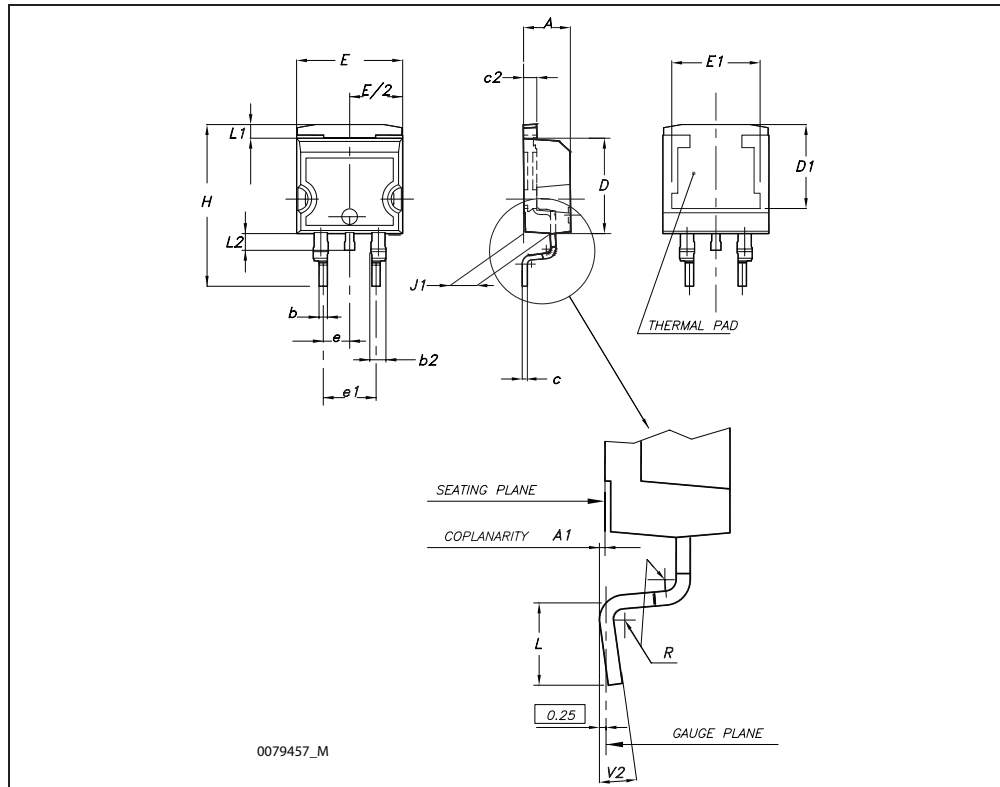

5 Packaging mechanical data

D²PAK FOOTPRINT

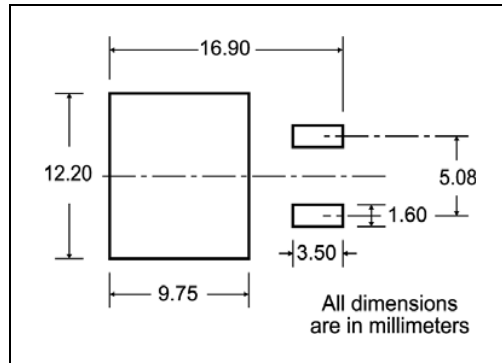

TAPE AND REEL SHIPMENT

40 mm min. Access hole at slot location

Full radius

Tape slot in core for tape start 2.5mm min. width

T

C

N

G measured at hub

REEL MECHANICAL DATA

DIM.	mm		inch	
	MIN.	MAX.	MIN.	MAX.
A		330		12.992
B	1.5		0.059	
C	12.8	13.2	0.504	0.520
D	20.2		0.795	
G	24.4	26.4	0.960	1.039
N	100		3.937	
T		30.4		1.197

BASE QTY	BULK QTY
1000	1000

TAPE MECHANICAL DATA

DIM.	mm		inch	
	MIN.	MAX.	MIN.	MAX.
A0	10.5	10.7	0.413	0.421
B0	15.7	15.9	0.618	0.626
D	1.5	1.6	0.059	0.063
D1	1.59	1.61	0.062	0.063
E	1.65	1.85	0.065	0.073
F	11.4	11.6	0.449	0.456
K0	4.8	5.0	0.189	0.197
P0	3.9	4.1	0.153	0.161
P1	11.9	12.1	0.468	0.476
P2	1.9	2.1	0.075	0.082
R	50		1.574	
T	0.25	0.35	0.0098	0.0137
W	23.7	24.3	0.933	0.956

10 pitches cumulative tolerance on tape +/- 0.2 mm

TOP COVER TAPE

Center line of cavity

User Direction of Feed

FEED DIRECTION

Bending radius R min.

* on sales tvoe

DPAK FOOTPRINT

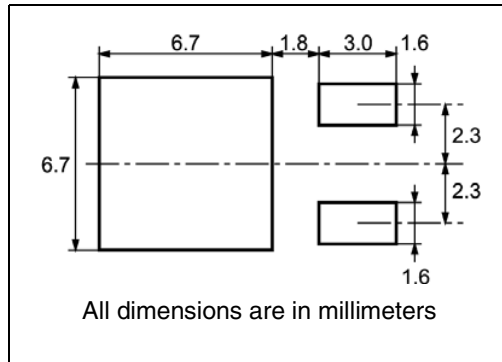

TAPE AND REEL SHIPMENT

REEL MECHANICAL DATA

DIM.	mm		inch	
	MIN.	MAX.	MIN.	MAX.
A		330		12.992
B	1.5		0.059	
C	12.8	13.2	0.504	0.520
D	20.2		0.795	
G	16.4	18.4	0.645	0.724
N	50		1.968	
T		22.4		0.881

TAPE MECHANICAL DATA

DIM.	mm		inch	
	MIN.	MAX.	MIN.	MAX.
A0	6.8	7	0.267	0.275
B0	10.4	10.6	0.409	0.417
B1		12.1		0.476
D	1.5	1.6	0.059	0.063
D1	1.5		0.059	
E	1.65	1.85	0.065	0.073
F	7.4	7.6	0.291	0.299
K0	2.55	2.75	0.100	0.108
P0	3.9	4.1	0.153	0.161
P1	7.9	8.1	0.311	0.319
P2	1.9	2.1	0.075	0.082
R	40		1.574	
W	15.7	16.3	0.618	0.641

6 Revision history

Table 9. Document revision history

Date	Revision	Changes
23-Sep-2008	1	First release
10-Jun-2009	2	Added new package, mechanical data: TO-220FP

Please Read Carefully:

Information in this document is provided solely in connection with ST products. STMicroelectronics NV and its subsidiaries ("ST") reserve the right to make changes, corrections, modifications or improvements, to this document, and the products and services described herein at any time, without notice.

All ST products are sold pursuant to ST's terms and conditions of sale.

Purchasers are solely responsible for the choice, selection and use of the ST products and services described herein, and ST assumes no liability whatsoever relating to the choice, selection or use of the ST products and services described herein.

No license, express or implied, by estoppel or otherwise, to any intellectual property rights is granted under this document. If any part of this document refers to any third party products or services it shall not be deemed a license grant by ST for the use of such third party products or services, or any intellectual property contained therein or considered as a warranty covering the use in any manner whatsoever of such third party products or services or any intellectual property contained therein.

UNLESS OTHERWISE SET FORTH IN ST'S TERMS AND CONDITIONS OF SALE ST DISCLAIMS ANY EXPRESS OR IMPLIED WARRANTY WITH RESPECT TO THE USE AND/OR SALE OF ST PRODUCTS INCLUDING WITHOUT LIMITATION IMPLIED WARRANTIES OF MERCHANTABILITY, FITNESS FOR A PARTICULAR PURPOSE (AND THEIR EQUIVALENTS UNDER THE LAWS OF ANY JURISDICTION), OR INFRINGEMENT OF ANY PATENT, COPYRIGHT OR OTHER INTELLECTUAL PROPERTY RIGHT.

UNLESS EXPRESSLY APPROVED IN WRITING BY AN AUTHORIZED ST REPRESENTATIVE, ST PRODUCTS ARE NOT RECOMMENDED, AUTHORIZED OR WARRANTED FOR USE IN MILITARY, AIR CRAFT, SPACE, LIFE SAVING, OR LIFE SUSTAINING APPLICATIONS, NOR IN PRODUCTS OR SYSTEMS WHERE FAILURE OR MALFUNCTION MAY RESULT IN PERSONAL INJURY, DEATH, OR SEVERE PROPERTY OR ENVIRONMENTAL DAMAGE. ST PRODUCTS WHICH ARE NOT SPECIFIED AS "AUTOMOTIVE GRADE" MAY ONLY BE USED IN AUTOMOTIVE APPLICATIONS AT USER'S OWN RISK.

Resale of ST products with provisions different from the statements and/or technical features set forth in this document shall immediately void any warranty granted by ST for the ST product or service described herein and shall not create or extend in any manner whatsoever, any liability of ST.

ST and the ST logo are trademarks or registered trademarks of ST in various countries.

Information in this document supersedes and replaces all information previously supplied.

The ST logo is a registered trademark of STMicroelectronics. All other names are the property of their respective owners.

© 2009 STMicroelectronics - All rights reserved

STMicroelectronics group of companies

Australia - Belgium - Brazil - Canada - China - Czech Republic - Finland - France - Germany - Hong Kong - India - Israel - Italy - Japan - Malaysia - Malta - Morocco - Philippines - Singapore - Spain - Sweden - Switzerland - United Kingdom - United States of America

www.st.com