



NC4MXX-B

The next generation of the worldwide accepted standard of XLR cable connectors. The successor of the X series offers several new features which make it more reliable, easier to assemble and improves contact integrity as well cable strain relief.

4 pole male cable connector with black metal housing and gold contacts.

Features & Benefits

- Male connector with improved locking recess without "window", more stringent housing increases durability
- Improved chuck type strain relief provides higher pull-out force and makes assembly easier and faster
- Boot with polyurethane gland gives high protection to cable bending stresses
- Colored rings and boots available for coding or identification
- Sleek and ergonomic design - valuable and handy
- Rugged zinc diecast shell, longlasting and dependable

ACCESSORIES

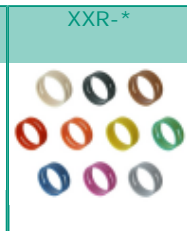
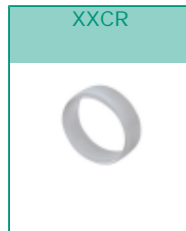
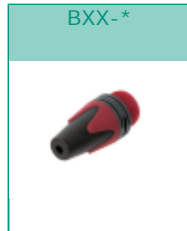

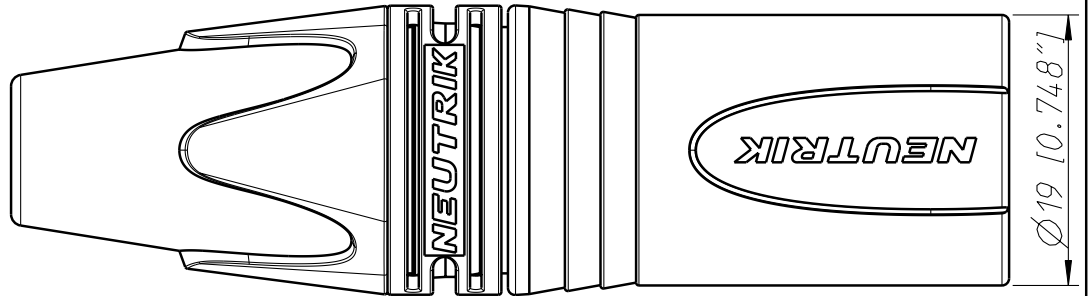
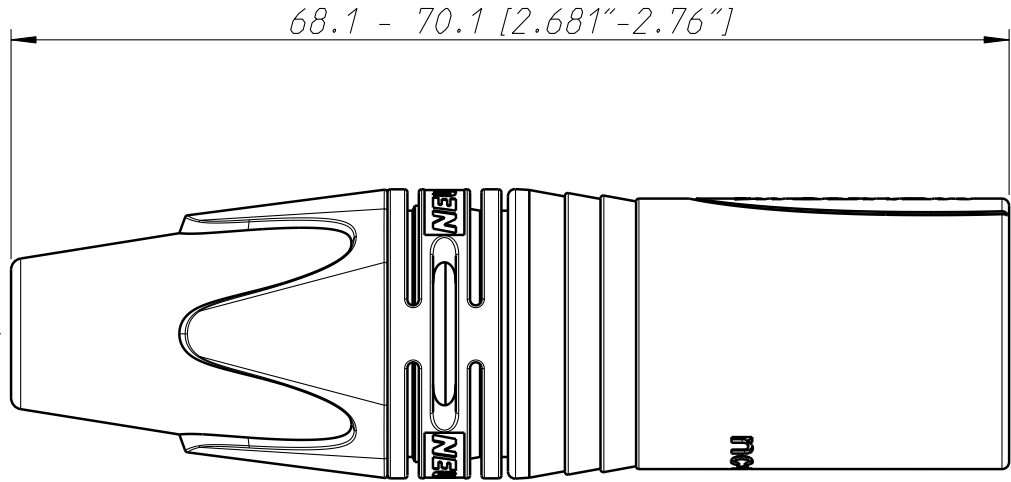
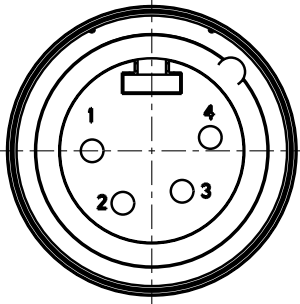

Allgemeintoleranzen ISO 2768-m	Werkstoff KEIN_MAT -	Massstab: 2:1 (A4)	Gezeichnet	06.12.05	jutz b
			Freigegeben	-	-
Zeichnung urheberrechtlich geschuetzt (DIN 34) (C)			Geaendert	17.04.07	jutz b
			Aend.-Nr.	-	Aend.-Index B
Benennung XX-Serie NC4MXX			Ersatz fuer:	Blatt 1 von 1 Bl.	
NEUTRIK AG FL-9494 SCHAAN			Zeichn. Nr. ST-NC4MXX		



XX Series

NC4MXX-B

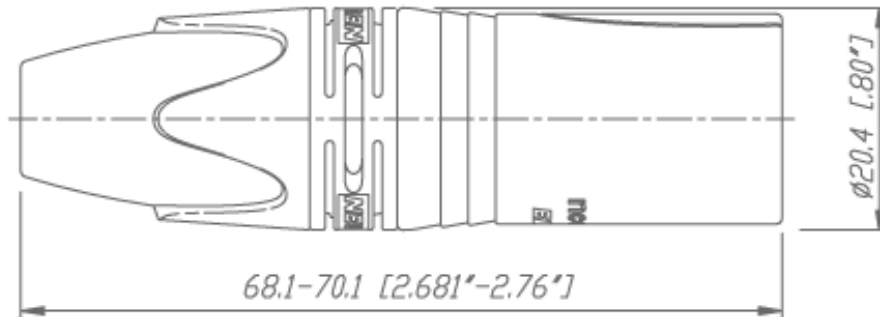

There are no technical infos for this product.

Product	
Connector Type	XLR
Gender	male
Electrical	
Capacitance between contacts	≤ 7 pF
Contact resistance	≤ 3 m Ω
Dielectric strength	1,5 kVdc
Insulation resistance	> 2 G Ω (initial)
Insulation resistance	> 1 G Ω (after damp heat test)
Rated current per contact	10 A
Rated voltage	50 V
Mechanical	
Cable O.D.	3.5 - 8.0 mm
Insertion force	≤ 20 N
Withdrawal force	≤ 20 N
Lifetime	> 1000 mating cycles
Wire size	max. 1.5 mm ²
Wire size	max. 16 AWG
Wiring	Solder contacts
Locking device	latch lock
Material	
Boot	Polyuretan
Bushing	Polyamide (PA 6 15% GR)

Contact plating	0.2 µm AuCo over 2 µm NiP15 (Tribor®)
Contacts	Brass (CuZn39Pb3)
Insert	Polyamdie (PA 6.6 30 % GR)
Locking element	St3K32 (latch) / Ck 67 (spring)
Shell	Zinc diecast (ZnAl4Cu1)
Shell plating	Black chromium
Strain relief	Polyacetal (POM)

Environmental

Flammability	UL 94 HB
Standard compliance	IEC 61076-2-103
Protection class	IP 40
Solderability	Complies with IEC 68-2-20
Temperature range	-30 °C to +80 °C

Optical

Mobile Cables