



Designers' Choice

# "AUTO" FUSE CLIPS & HOLDERS

- Available for standard and mini blade fuses
- Thru hole PC mountable, maintains position during wave soldering
- Space saving, low profile designs

- Horizontal and vertical mini blade clip for Littelfuse ATO 297 series and Bussmann ATM fuses
- Withstands the rigors of shock and vibration

- Horizontal and vertical standard blade clips for Littelfuse ATO 257 series and Bussmann ATC fuses
- Holds fuses securely, even after multiple insertions

- Orientation legs assure proper PC installation

Voltage Rating: 500VAC  
Current Rating: 30 Amps or as noted

## PC AUTOMOTIVE BLADE FUSE CLIPS

FOR .205 x .025 STANDARD BLADE FUSES

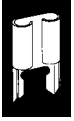

.016 Brass, Nickel Plate

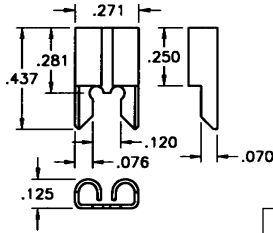

Mounting Detail For Two Clips

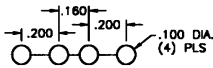

Current Rating: 40 Amps

CAT. NO. 3522 - Vertical

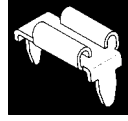

.012 Brass, Nickel Plate

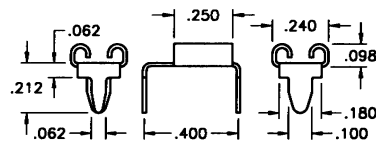

Mounting Detail For Two Clips

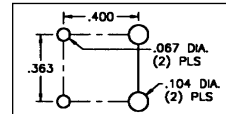

Current Rating: 40 Amps

CAT. NO. 3550 - Horizontal

FOR .110 x .032 MINI BLADE FUSES



.016 Brass, Nickel Plate

- Low Profile

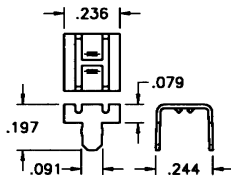

Mounting Detail For Two Clips

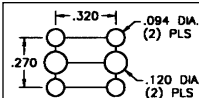

CAT. NO. 3564 - Vertical

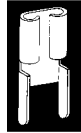

.012 Brass, Nickel Plate

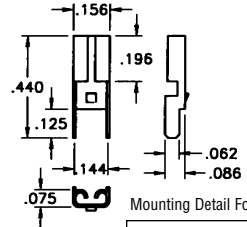

Mounting Detail For Two Clips

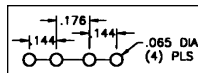

CAT. NO. 3544 - Vertical

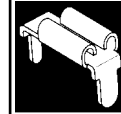

.012 Brass, Nickel Plate

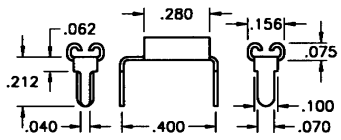

Mounting Detail For Two Clips

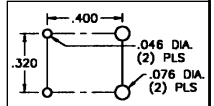

CAT. NO. 3549 - Horizontal

## PC AUTOMOTIVE BLADE FUSE HOLDERS

- Thru hole PC mountable, maintains position during wave soldering
- Holder design prevents solder wicking
- Withstands the rigors of shock and vibration
- Holds fuse securely, even after multiple insertions
- Suitable for 40 Amp applications

### SPECIFICATIONS

Contacts: Brass, Nickel Plate; Insulator: Glass Filled Nylon, UL Rated 94V-0  
Current Rating: 30 Amps; Voltage Rating: 500VAC  
Temperature Rating: -58°F to +292°F (-50°C to +145°C)

FOR .205 x .025 STANDARD BLADE FUSES



CAT. NO. 3522-2

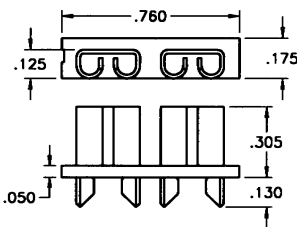

Mounting Detail

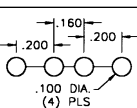

FOR .110 x .032 MINI BLADE FUSES



CAT. NO. 3544-2

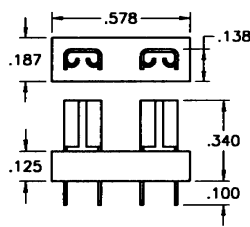

Mounting Detail

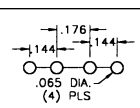

## MODULAR PC AUTOMOTIVE BLADE FUSE HOLDER

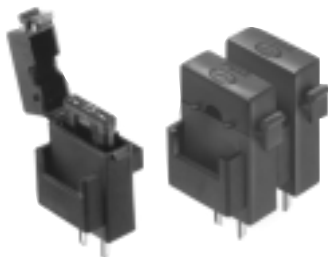

CAT. NO. 3560

- Designed for standard auto blade fuses
- Fully insulated compact design
- Mounts easily in pre-drilled or punched hole
- Holder has pocket to hold spare fuse
- Safety lever release clip will not open under shock or vibration
- Fuses are installed and removed easily
- May be used individually or easily interlocked for multiple mounting

### SPECIFICATIONS

Contacts: Brass, Tin Plate Body: Nylon, UL Rated 94V-0  
Dielectric Strength: (60 seconds) 1500VAC/min.  
Current Rating: 30 Amps

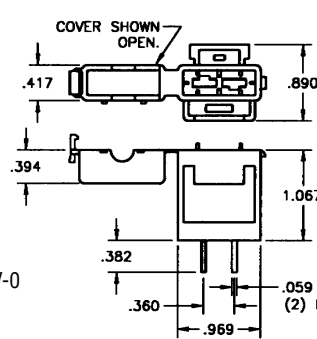

Mounting Detail

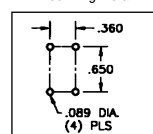

Mounting Detail For Two Holders

