



Designers' Choice

FUSE CLIPS & HOLDERS

9/32 FUSE CLIP



.020 Brass, Nickel Plate
Current Rating: 15 Amps

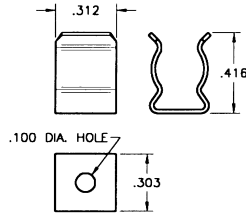

CAT. NO. 3565

13/32 PC FUSE CLIP



.028 Brass, Tin Plate
Current Rating: 30 Amps

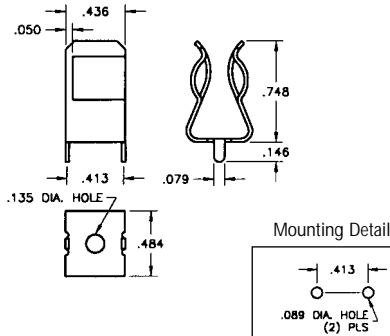

CAT. NO. 3566

CUSTOM FUSE CLIPS & HOLDERS

Keystone is fully integrated to meet your total design & production needs.

Manufacturing custom designs & modifications of standard items is our specialty.

Quotations on special fuse clips & holders furnished promptly upon receipt of sample, sketch, print or CAD drawings.

PC 5mm FUSE HOLDERS

SLIM LINE & (OPTIONAL) COVER

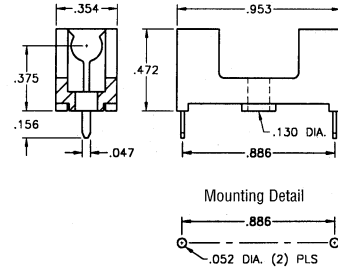
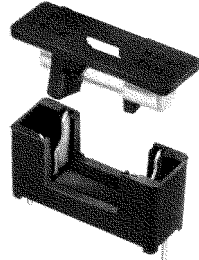

- Optional cover with window protects and insulates fuse

CAT. NO. 4628 – Holder
CAT. NO. 4628C – Cover only (with window)

SPECIFICATIONS

Base & Cover: Nylon, UL94V-0
Contacts: Brass, Tin Plate
Rated: 5 Amp @ 250V

LOW PROFILE & (OPTIONAL) COVER

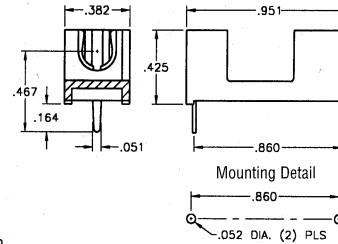
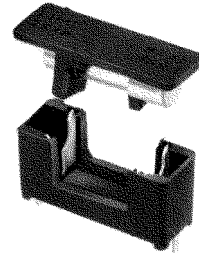

- Low profile, space saving design
- Optional cover protects and insulates fuse

CAT. NO. 4527 – Holder
CAT. NO. 4527C – Cover only

SPECIFICATIONS

Base & Cover: Nylon, UL94V-0
Contacts: Brass, Tin Plate
Rated: 5 Amp @ 250V

PC SNAP-IN FUSE HOLDER

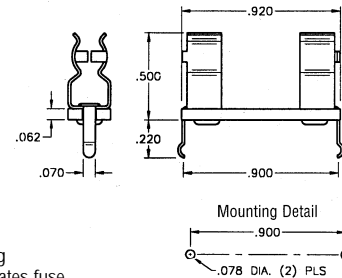

- Low profile, space saving design
- Snap-in design for wave soldering
- Optional cover protects and insulates fuse

CAT. NO. 3527 – Holder
CAT. NO. 3527C – Vinyl cover only

SPECIFICATIONS

Base: .062 G-10, UL Rated 94V-0
Clips: Brass, Tin Plate
Rated: 6.3 Amps @ 250V

5mm & 3AG FUSE COVERS



Vinyl

5mm

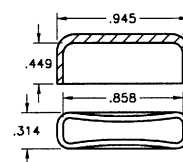

CAT. NO. 3527C

3AG

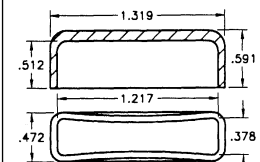

CAT. NO. 4245C