

Transil™ arrays for ESD protection

Features

- 5 uni-directional Transil diodes
- Breakdown voltage $V_{BR} = 6.1 \text{ V min.}$
- Low leakage current $< 200 \text{ nA}$
- Very small PCB area: 1.0 mm^2
- $350 \text{ }\mu\text{m}$ pitch micro-package
- Lead-free and RoHS package
- High ESD protection level
- High integration
- Suitable for high density boards

Complies with the following standards

- IEC 61000-4-2 level 4:
 - 15 kV (air discharge)
 - 8 kV (contact discharge)
- MIL STD 883G- Method 3015-7: class 3B
 - HBM (human body model)

Applications

Where transient overvoltage protection in ESD sensitive equipment is required, such as:

- Cellular phone handsets and accessories
- Computers
- Printers
- Communication systems
- Video equipment
- Set top boxes

Description

The ESDA6V1-5T6 is monolithic arrays designed to protect up to 5 lines against ESD transients.

The device is ideal for applications where both reduced print circuit board space and high ESD protection level are required.

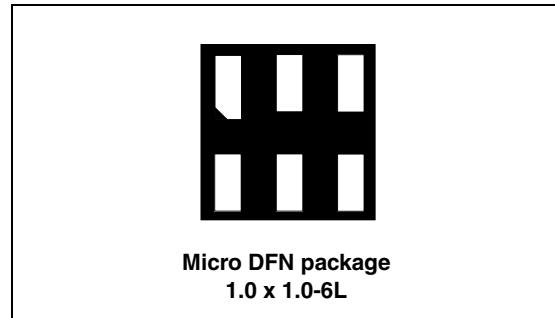
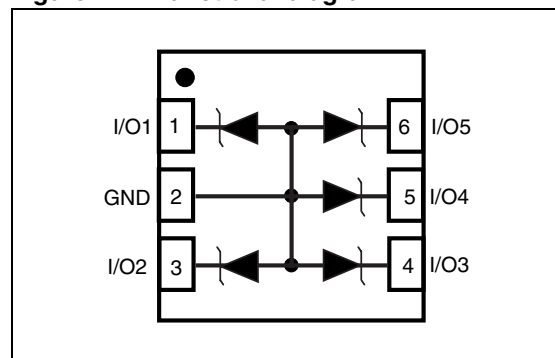

Figure 1. Functional diagram



TM: Transil is a trademark of STMicroelectronics

1 Characteristics

Table 1. Absolute maximum ratings ($T_{amb} = 25\text{ °C}$)

Symbol	Parameter	Value	Unit	
V_{PP}	ESD IEC 61000-4-2, air discharge	15	kV	
	ESD IEC 61000-4-2, contact discharge	8		
P_{PP}	Peak pulse power dissipation (8/20 μ s) ⁽¹⁾	T_j initial = T_{amb}	35	W
I_{pp}	Repetitive peak pulse current typical value (8/20 μ s)	3	A	
T_j	Junction temperature	125	°C	
T_{stg}	Storage temperature range	-55 + 150	°C	
T_L	Maximum lead temperature for soldering during 10 s	260	°C	

1. For a surge greater than the maximum values, the diode will fail in short-circuit.

Figure 2. Electrical characteristics (definitions)

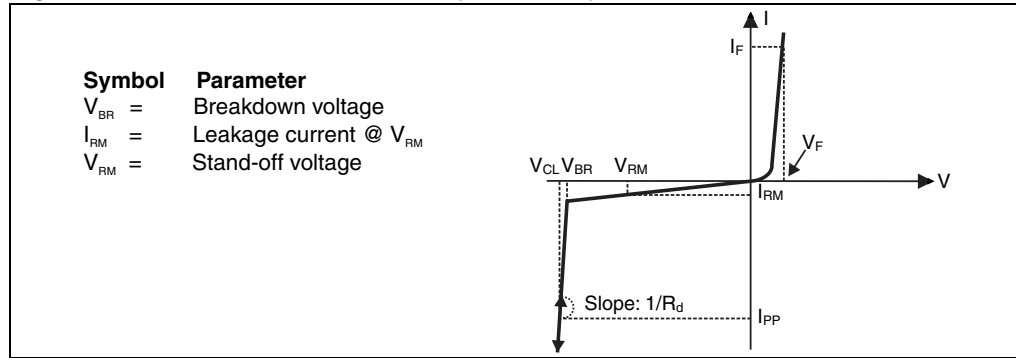

Table 2. Electrical characteristics (values, $T_{amb} = 25\text{ °C}$)

Symbol	Test conditions	Min.	Typ.	Max.	Unit
V_{BR}	$I_R = 1\text{ mA}$	6.1		7.2	V
I_{RM}	$V_{RM} = 3\text{ V}$			200	nA
C	$V_R = 3\text{ V DC}$, $F_{OSC} = 1\text{ MHz}$, $V_{OSC} = 30\text{ mV}_{RMS}$		34	70	pF

Figure 3. Relative variation of peak pulse power versus initial junction temperature

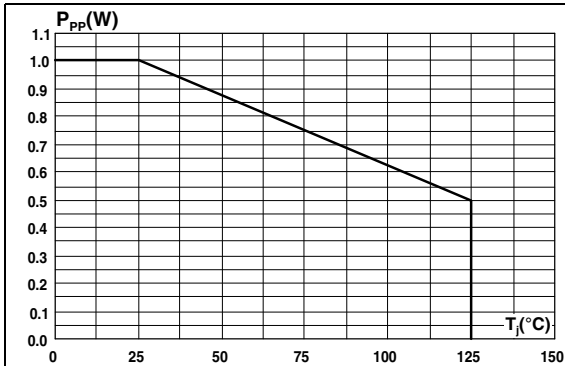

Figure 4. Peak pulse power versus exponential pulse duration

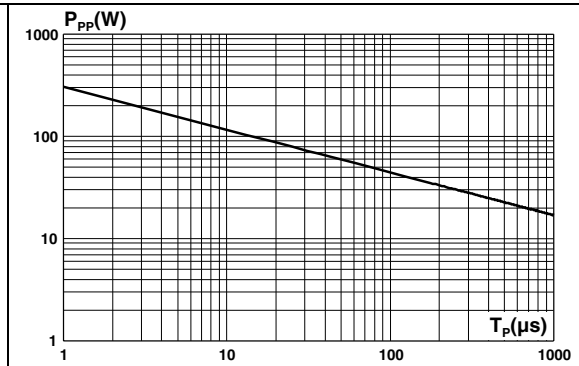

Figure 5. Clamping voltage versus peak pulse current (typical values, exponential waveform)

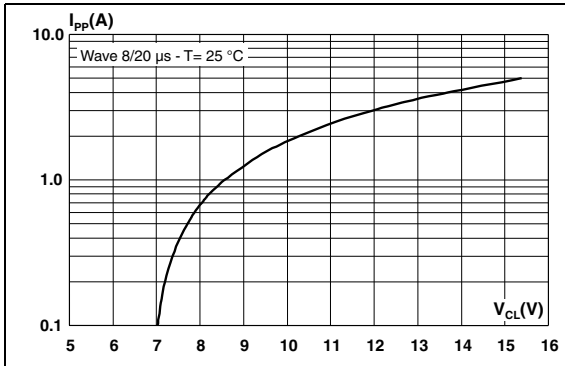

Figure 6. Forward voltage drop versus peak forward current (typical values)

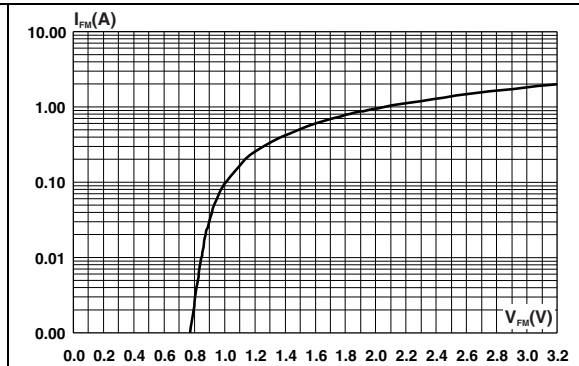

Figure 7. Junction capacitance versus reverse voltage applied (typical values)

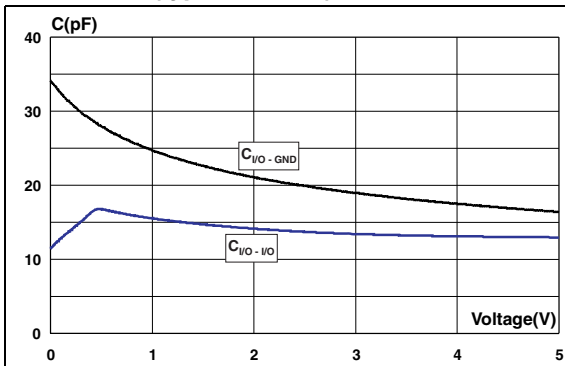

Figure 8. Relative variation of leakage current versus junction temperature (typical values)

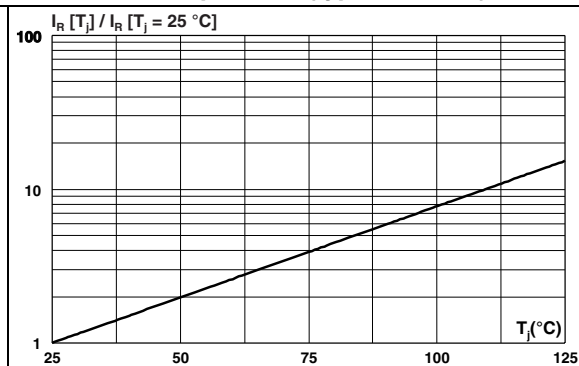

Figure 9. S21 attenuation measurement results of each channel

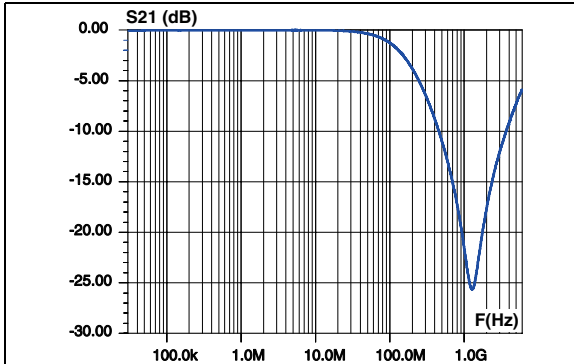

Figure 10. Analog crosstalk measurements between channels

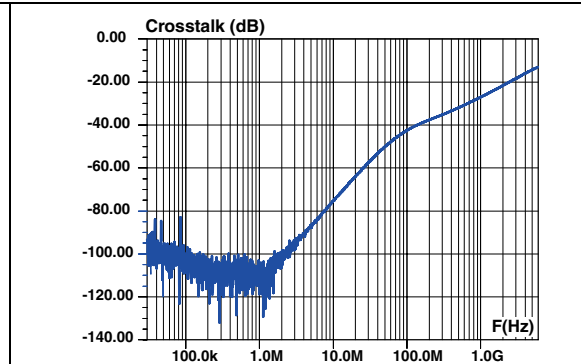

Figure 11. ESD response to IEC 61000-4-2 (+15 kV air discharge) on each channel

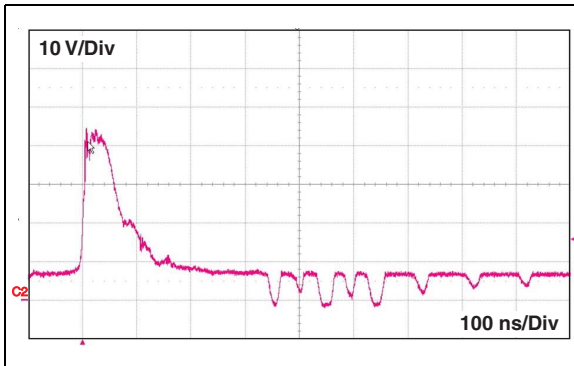
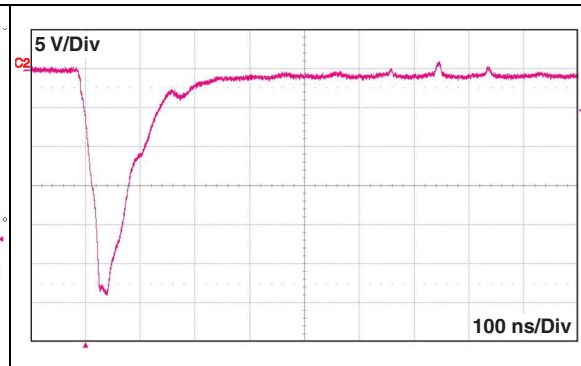
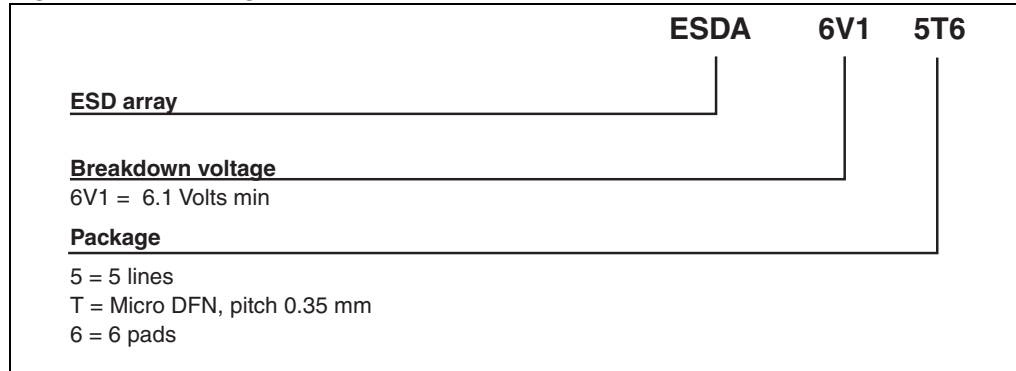

Figure 12. ESD response to IEC 61000-4-2 (-15 kV air discharge) on each channel



2 Ordering information scheme

Figure 13. Ordering information scheme



3 Package information

Table 3. Micro QFN 1.0 x 1.0-6L dimensions

Ref.	Dimensions					
	Millimeters			Inches		
	Min.	Typ.	Max.	Min.	Typ.	Max.
A	0.31	-	0.40	0.012	-	0.016
A1	0.00	0.02	0.05	0.00	0.0008	0.002
b	0.10	0.15	0.20	0.004	0.006	0.008
D	0.95	1.00	1.05	0.037	0.039	0.041
E	0.95	1.00	1.05	0.037	0.039	0.041
L1	0.22	0.32	0.42	0.009	0.012	0.016
e	-	0.35	-	-	0.014	-

Figure 14. Footprint dimensions (in millimeters)

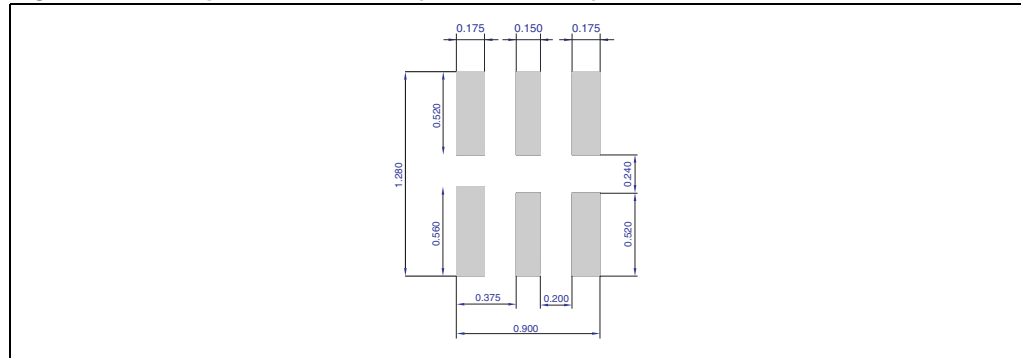
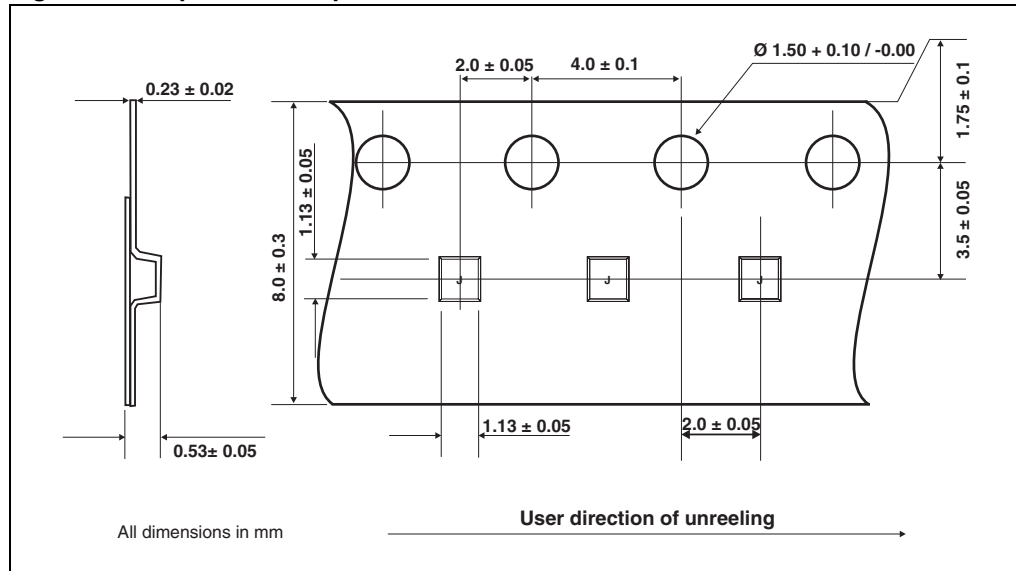

Figure 15. Tape and reel specifications



4 Recommendation on PCB assembly

4.1 Stencil opening design

1. General recommendation on stencil opening design
 - a) Stencil opening dimensions: L (Length), W (Width), T (Thickness).

Figure 16. Stencil opening dimensions

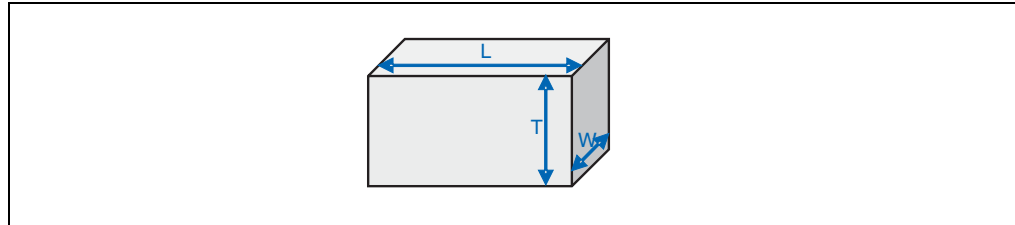

- b) General design rule

Stencil thickness (T) = 75 ~ 125 μm

$$\text{Aspect Ratio} = \frac{W}{T} \geq 1.5$$

$$\text{Aspect Area} = \frac{L \times W}{2T(L + W)} \geq 0.66$$

2. Reference design
 - a) Stencil opening thickness: 100 μm
 - b) Stencil opening for central exposed pad: Opening to footprint ratio is 50%.
 - c) Stencil opening for leads: Opening to footprint ratio is 90%.

Figure 17. Recommended stencil window position

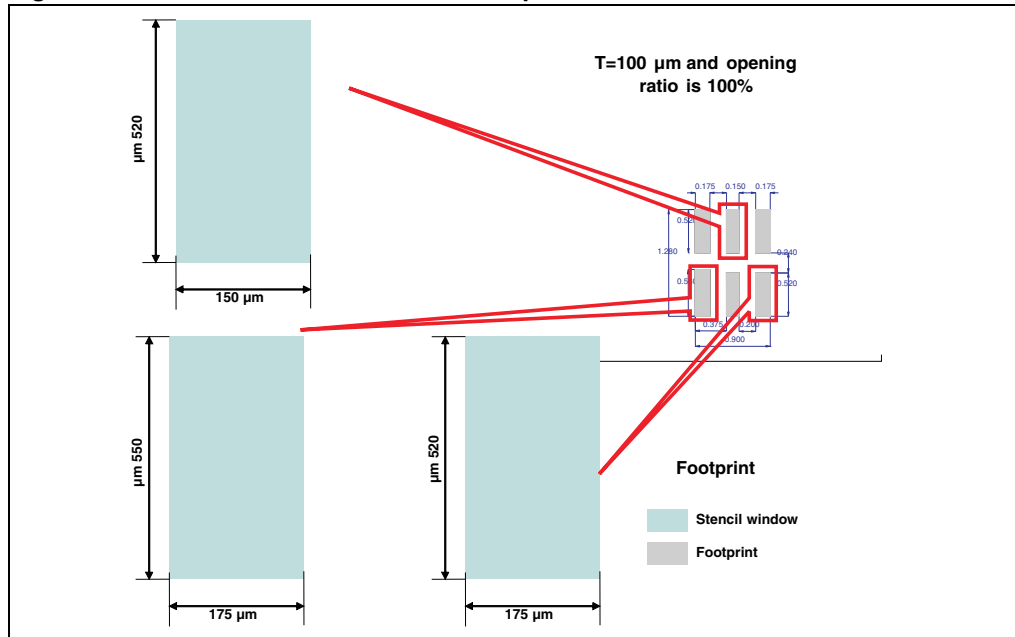

4.2 Solder paste

1. Halide-free flux qualification ROL0 according to ANSI/J-STD-004.
2. "No clean" solder paste is recommended.
3. Offers a high tack force to resist component movement during high speed.
4. Solder paste with fine particles: powder particle size is 20-45 μm .

4.3 Placement

1. Manual positioning is not recommended.
2. It is recommended to use the lead recognition capabilities of the placement system, not the outline centering.
3. Standard tolerance of ± 0.05 mm is recommended.
4. 3.5 N placement force is recommended. Too much placement force can lead to squeezed out solder paste and cause solder joints to short. Too low placement force can lead to insufficient contact between package and solder paste that could cause open solder joints or badly centered packages.
5. To improve the package placement accuracy, a bottom side optical control should be performed with a high resolution tool.
6. For assembly, a perfect supporting of the PCB (all the more on flexible PCB) is recommended during solder paste printing, pick and place and reflow soldering by using optimized tools.

4.4 PCB design preference

1. To control the solder paste amount, the closed via is recommended instead of open vias.
2. The position of tracks and open vias in the solder area should be well balanced. The symmetrical layout is recommended, in case any tilt phenomena caused by asymmetrical solder paste amount due to the solder flow away.

4.5 Reflow profile

Figure 18. ST ECOPACK® recommended soldering reflow profile for PCB mounting

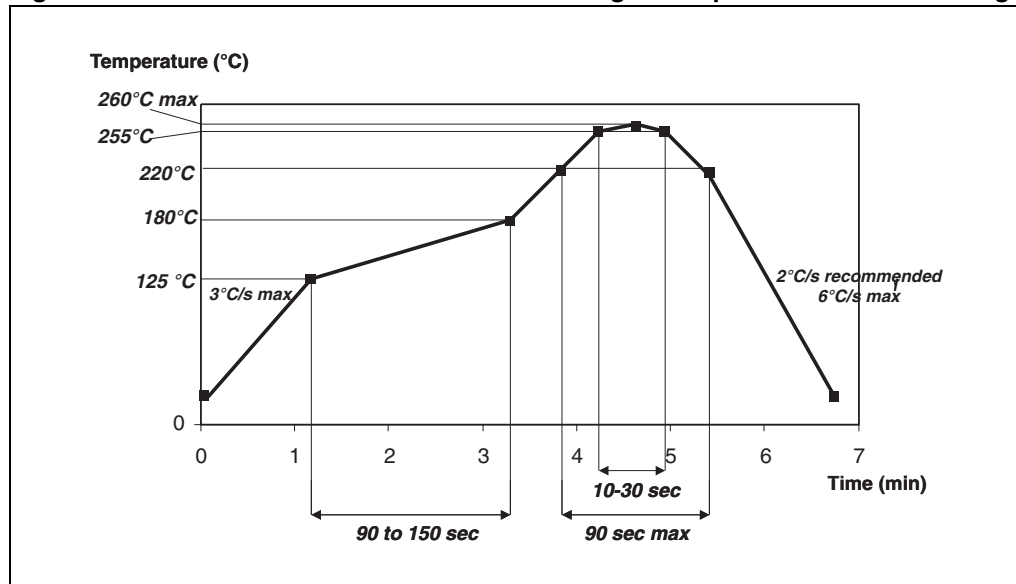

Note: Minimize air convection currents in the reflow oven to avoid component movement.

5 Ordering information

Table 4. Ordering information

Order code	Marking	Package	Weight	Base qty	Delivery mode
ESDA6V1-5T6	J	DFN1.0x1.0-6L	1.78 mg	3000	Tape and reel

6 Revision history

Table 5. Document revision history

Date	Revision	Changes
21-Jan-2010	1	Initial release.

Please Read Carefully:

Information in this document is provided solely in connection with ST products. STMicroelectronics NV and its subsidiaries ("ST") reserve the right to make changes, corrections, modifications or improvements, to this document, and the products and services described herein at any time, without notice.

All ST products are sold pursuant to ST's terms and conditions of sale.

Purchasers are solely responsible for the choice, selection and use of the ST products and services described herein, and ST assumes no liability whatsoever relating to the choice, selection or use of the ST products and services described herein.

No license, express or implied, by estoppel or otherwise, to any intellectual property rights is granted under this document. If any part of this document refers to any third party products or services it shall not be deemed a license grant by ST for the use of such third party products or services, or any intellectual property contained therein or considered as a warranty covering the use in any manner whatsoever of such third party products or services or any intellectual property contained therein.

UNLESS OTHERWISE SET FORTH IN ST'S TERMS AND CONDITIONS OF SALE ST DISCLAIMS ANY EXPRESS OR IMPLIED WARRANTY WITH RESPECT TO THE USE AND/OR SALE OF ST PRODUCTS INCLUDING WITHOUT LIMITATION IMPLIED WARRANTIES OF MERCHANTABILITY, FITNESS FOR A PARTICULAR PURPOSE (AND THEIR EQUIVALENTS UNDER THE LAWS OF ANY JURISDICTION), OR INFRINGEMENT OF ANY PATENT, COPYRIGHT OR OTHER INTELLECTUAL PROPERTY RIGHT.

UNLESS EXPRESSLY APPROVED IN WRITING BY AN AUTHORIZED ST REPRESENTATIVE, ST PRODUCTS ARE NOT RECOMMENDED, AUTHORIZED OR WARRANTED FOR USE IN MILITARY, AIR CRAFT, SPACE, LIFE SAVING, OR LIFE SUSTAINING APPLICATIONS, NOR IN PRODUCTS OR SYSTEMS WHERE FAILURE OR MALFUNCTION MAY RESULT IN PERSONAL INJURY, DEATH, OR SEVERE PROPERTY OR ENVIRONMENTAL DAMAGE. ST PRODUCTS WHICH ARE NOT SPECIFIED AS "AUTOMOTIVE GRADE" MAY ONLY BE USED IN AUTOMOTIVE APPLICATIONS AT USER'S OWN RISK.

Resale of ST products with provisions different from the statements and/or technical features set forth in this document shall immediately void any warranty granted by ST for the ST product or service described herein and shall not create or extend in any manner whatsoever, any liability of ST.

ST and the ST logo are trademarks or registered trademarks of ST in various countries.

Information in this document supersedes and replaces all information previously supplied.

The ST logo is a registered trademark of STMicroelectronics. All other names are the property of their respective owners.

© 2010 STMicroelectronics - All rights reserved

STMicroelectronics group of companies

Australia - Belgium - Brazil - Canada - China - Czech Republic - Finland - France - Germany - Hong Kong - India - Israel - Italy - Japan - Malaysia - Malta - Morocco - Philippines - Singapore - Spain - Sweden - Switzerland - United Kingdom - United States of America

www.st.com