

MC74HC273A

Octal D Flip-Flop with Common Clock and Reset

High-Performance Silicon-Gate CMOS

The MC74HC273A is identical in pinout to the LS273. The device inputs are compatible with standard CMOS outputs; with pullup resistors, they are compatible with LSTTL outputs.

This device consists of eight D flip-flops with common Clock and Reset inputs. Each flip-flop is loaded with a low-to-high transition of the Clock input. Reset is asynchronous and active low.

Features

- Output Drive Capability: 10 LSTTL Loads
- Outputs Directly Interface to CMOS, NMOS and TTL
- Operating Voltage Range: 2.0 to 6.0 V
- Low Input Current: 1.0 μ A
- High Noise Immunity Characteristic of CMOS Devices
- In Compliance with the Requirements Defined by JEDEC Standard No. 7A
- Chip Complexity: 264 FETs or 66 Equivalent Gates
- Pb-Free Packages are Available



ON Semiconductor®

MARKING DIAGRAMS

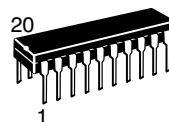

PDIP-20
N SUFFIX
CASE 738

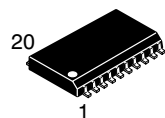
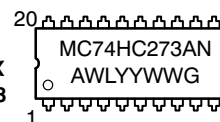

SOIC-20
DW SUFFIX
CASE 751D

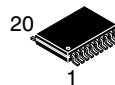
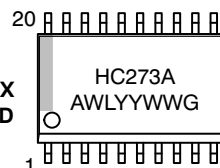

TSSOP-20
DT SUFFIX
CASE 948E

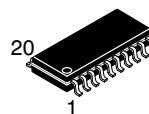
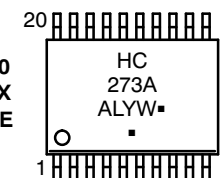

SOEIAJ-20
F SUFFIX
CASE 967

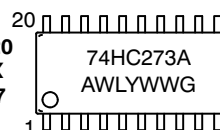

A = Assembly Location
WL, L = Wafer Lot
YY, Y = Year
WW, W = Work Week
G = Pb-Free Package
▪ = Pb-Free Package
(Note: Microdot may be in either location)

ORDERING INFORMATION

See detailed ordering and shipping information in the package dimensions section on page 2 of this data sheet.

MC74HC273A

PIN ASSIGNMENT

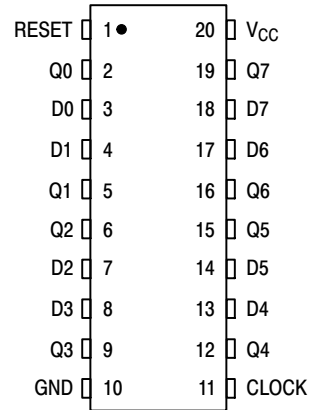

LOGIC DIAGRAM

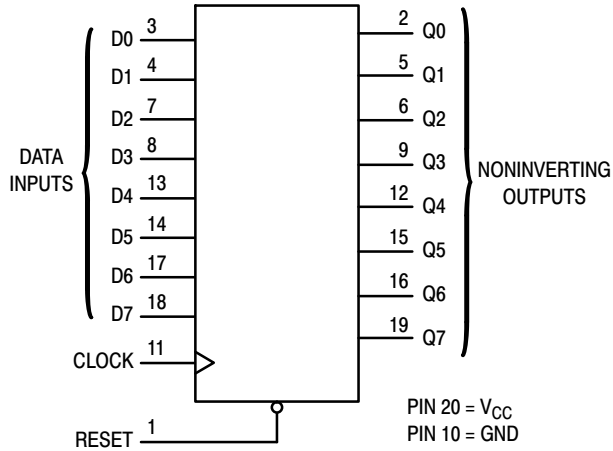

FUNCTION TABLE

Inputs			Output
Reset	Clock	D	Q
L	X	X	L
H		H	H
H		L	L
H	L	X	No Change
H		X	No Change

Design Criteria	Value	Units
Internal Gate Count*	66	ea
Internal Gate Propagation Delay	1.5	ns
Internal Gate Power Dissipation	5.0	μ W
Speed Power Product	.0075	pJ

*Equivalent to a two-input NAND gate.

ORDERING INFORMATION

Device	Package	Shipping [†]
MC74HC273AN	PDIP-20	18 Units / Rail
MC74HC273ANG	PDIP-20 (Pb-Free)	18 Units / Rail
MC74HC273ADW	SOIC-20 WIDE	38 Units / Rail
MC74HC273ADWG	SOIC-20 WIDE (Pb-Free)	38 Units / Rail
MC74HC273ADWR2	SOIC-20 WIDE	1000 Tape & Reel
MC74HC273ADWR2G	SOIC-20 WIDE (Pb-Free)	1000 Tape & Reel
MC74HC273ADT	TSSOP-20*	75 Units / Rail
MC74HC273ADTG	TSSOP-20*	75 Units / Rail
MC74HC273ADTR2	TSSOP-20*	2500 Tape & Reel
MC74HC273ADTR2G	TSSOP-20*	2500 Tape & Reel
MC74HC273AF	SOEIAJ-20	40 Units / Rail
MC74HC273AFG	SOEIAJ-20 (Pb-Free)	40 Units / Rail
MC74HC273AFEL	SOEIAJ-20	2000 Tape & Reel
MC74HC273AFELG	SOEIAJ-20 (Pb-Free)	2000 Tape & Reel

[†]For information on tape and reel specifications, including part orientation and tape sizes, please refer to our Tape and Reel Packaging Specifications Brochure, BRD8011/D.

*This package is inherently Pb-Free.

MC74HC273A

MAXIMUM RATINGS

Symbol	Parameter	Value	Unit
V_{CC}	DC Supply Voltage (Referenced to GND)	- 0.5 to + 7.0	V
V_{in}	DC Input Voltage (Referenced to GND)	- 0.5 to $V_{CC} + 0.5$	V
V_{out}	DC Output Voltage (Referenced to GND)	- 0.5 to $V_{CC} + 0.5$	V
I_{in}	DC Input Current, per Pin	± 20	mA
I_{out}	DC Output Current, per Pin	± 25	mA
I_{CC}	DC Supply Current, V_{CC} and GND Pins	± 50	mA
P_D	Power Dissipation in Still Air, Plastic DIP† SOIC Package† TSSOP Package†	750 500 450	mW
T_{stg}	Storage Temperature	- 65 to + 150	°C
T_L	Lead Temperature, 1 mm from Case for 10 Seconds Plastic DIP, SOIC or TSSOP Package	260	°C

This device contains protection circuitry to guard against damage due to high static voltages or electric fields. However, precautions must be taken to avoid applications of any voltage higher than maximum rated voltages to this high-impedance circuit. For proper operation, V_{in} and V_{out} should be constrained to the range $GND \leq (V_{in} \text{ or } V_{out}) \leq V_{CC}$. Unused inputs must always be tied to an appropriate logic voltage level (e.g., either GND or V_{CC}). Unused outputs must be left open.

Stresses exceeding Maximum Ratings may damage the device. Maximum Ratings are stress ratings only. Functional operation above the Recommended Operating Conditions is not implied. Extended exposure to stresses above the Recommended Operating Conditions may affect device reliability.

†Derating — Plastic DIP: - 10 mW/°C from 65° to 125°C
SOIC Package: - 7 mW/°C from 65° to 125°C
TSSOP Package: - 6.1 mW/°C from 65° to 125°C

For high frequency or heavy load considerations, see Chapter 2 of the ON Semiconductor High-Speed CMOS Data Book (DL129/D).

RECOMMENDED OPERATING CONDITIONS

Symbol	Parameter	Min	Max	Unit
V_{CC}	DC Supply Voltage (Referenced to GND)	2.0	6.0	V
V_{in}, V_{out}	DC Input Voltage, Output Voltage (Referenced to GND)	0	V_{CC}	V
T_A	Operating Temperature, All Package Types	- 55	+ 125	°C
t_r, t_f	Input Rise and Fall Time (Figure 1)			ns
	$V_{CC} = 2.0 \text{ V}$	0	1000	
	$V_{CC} = 4.5 \text{ V}$	0	500	
	$V_{CC} = 6.0 \text{ V}$	0	400	

DC ELECTRICAL CHARACTERISTICS (Voltages Referenced to GND)

Symbol	Parameter	Test Conditions	V_{CC} V	Guaranteed Limit			Unit
				- 55 to 25°C	$\leq 85^\circ\text{C}$	$\leq 125^\circ\text{C}$	
V_{IH}	Minimum High-Level Input Voltage	$V_{out} = V_{CC} - 0.1 \text{ V}$ $ I_{out} \leq 20 \mu\text{A}$	2.0	1.5	1.5	1.5	V
			3.0	2.1	2.1	2.1	
			4.5	3.15	3.15	3.15	
			6.0	4.2	4.2	4.2	
V_{IL}	Maximum Low-Level Input Voltage	$V_{out} = 0.1 \text{ V}$ $ I_{out} \leq 20 \mu\text{A}$	2.0	0.5	0.5	0.5	V
			3.0	0.9	0.9	0.9	
			4.5	1.35	1.35	1.35	
			6.0	1.8	1.8	1.8	
V_{OH}	Minimum High-Level Output Voltage	$V_{in} = V_{IH}$ $ I_{out} \leq 20 \mu\text{A}$	2.0	1.9	1.9	1.9	V
			4.5	4.4	4.4	4.4	
			6.0	5.9	5.9	5.9	
			$V_{in} = V_{IH}$	$ I_{out} \leq 2.4 \text{ mA}$	3.0	2.48	
	$ I_{out} \leq 6.0 \text{ mA}$	4.5	3.98	3.84	3.7		
	$ I_{out} \leq 7.8 \text{ mA}$	6.0	5.48	5.34	5.2		
V_{OL}	Maximum Low-Level Output Voltage	$V_{in} = V_{IL}$ $ I_{out} \leq 20 \mu\text{A}$	2.0	0.1	0.1	0.1	V
			4.5	0.1	0.1	0.1	
			6.0	0.1	0.1	0.1	
			$V_{in} = V_{IL}$	$ I_{out} \leq 2.4 \text{ mA}$	3.0	0.26	
	$ I_{out} \leq 6.0 \text{ mA}$	4.5	0.26	0.33	0.4		
	$ I_{out} \leq 7.8 \text{ mA}$	6.0	0.26	0.33	0.4		

MC74HC273A

DC ELECTRICAL CHARACTERISTICS (Voltages Referenced to GND)

Symbol	Parameter	Test Conditions	V _{CC} V	Guaranteed Limit			Unit
				- 55 to 25°C	≤ 85°C	≤ 125°C	
I _{in}	Maximum Input Leakage Current	V _{in} = V _{CC} or GND	6.0	± 0.1	± 1.0	± 1.0	μA
I _{CC}	Maximum Quiescent Supply Current (per Package)	V _{in} = V _{CC} or GND I _{out} = 0 μA	6.0	4.0	40	160	μA

AC ELECTRICAL CHARACTERISTICS (C_L = 50 pF, Input t_r = t_f = 6.0 ns)

Symbol	Parameter	V _{CC} V	Guaranteed Limit			Unit
			- 55 to 25°C	≤ 85°C	≤ 125°C	
f _{max}	Maximum Clock Frequency (50% Duty Cycle) (Figures 1 and 4)	2.0	6.0	5.0	4.0	MHz
		3.0	15	10	8.0	
		4.5	30	24	20	
		6.0	35	28	24	
t _{PLH} t _{PHL}	Maximum Propagation Delay, Clock to Q (Figures 1 and 4)	2.0	145	180	220	ns
		3.0	90	120	140	
		4.5	29	36	44	
		6.0	25	31	38	
t _{PHL}	Maximum Propagation Delay, Reset to Q (Figures 2 and 4)	2.0	145	180	220	ns
		3.0	90	120	140	
		4.5	29	36	44	
		6.0	25	31	38	
t _{TLH} t _{THL}	Maximum Output Transition Time, Any Output (Figures 1 and 4)	2.0	75	95	110	ns
		3.0	27	32	36	
		4.5	15	19	22	
		6.0	13	16	19	
C _{in}	Maximum Input Capacitance		10	10	10	pF
C _{PD}	Power Dissipation Capacitance (Per Enabled Output)*	Typical @ 25°C, V _{CC} = 5.0 V			pF	
		48				

MC74HC273A

TIMING REQUIREMENTS ($C_L = 50$ pF, Input $t_r = t_f = 6.0$ ns)

Symbol	Parameter	Figure	V _{CC} Volts	Guaranteed Limit						Unit
				- 55 to 25°C		≤ 85°C		≤ 125°C		
				Min	Max	Min	Max	Min	Max	
t _{su}	Minimum Setup Time, Data to Clock	3	2.0	60		75		90	ns	
			3.0	23		27		32		
			4.5	12		15		18		
			6.0	10		13		15		
t _h	Minimum Hold Time, Clock to Data	3	2.0	3.0		3.0		3.0	ns	
			3.0	3.0		3.0		3.0		
			4.5	3.0		3.0		3.0		
			6.0	3.0		3.0		3.0		
t _{rec}	Minimum Recovery Time, Reset Inactive to Clock	2	2.0	5.0		5.0		5.0	ns	
			3.0	5.0		5.0		5.0		
			4.5	5.0		5.0		5.0		
			6.0	5.0		5.0		5.0		
t _w	Minimum Pulse Width, Clock	1	2.0	60		75		90	ns	
			3.0	23		27		32		
			4.5	12		15		18		
			6.0	10		13		15		
t _w	Minimum Pulse Width, Reset	2	2.0	60		75		90	ns	
			3.0	23		27		32		
			4.5	12		15		18		
			6.0	10		13		15		
t _r , t _f	Maximum Input Rise and Fall Times	1	2.0		1000		1000		1000	ns
			3.0		800		800		800	
			4.5		500		500		500	
			6.0		400		400		400	

MC74HC273A

PACKAGE DIMENSIONS

PDIP-20
N SUFFIX
PLASTIC DIP PACKAGE
CASE 738-03
ISSUE E

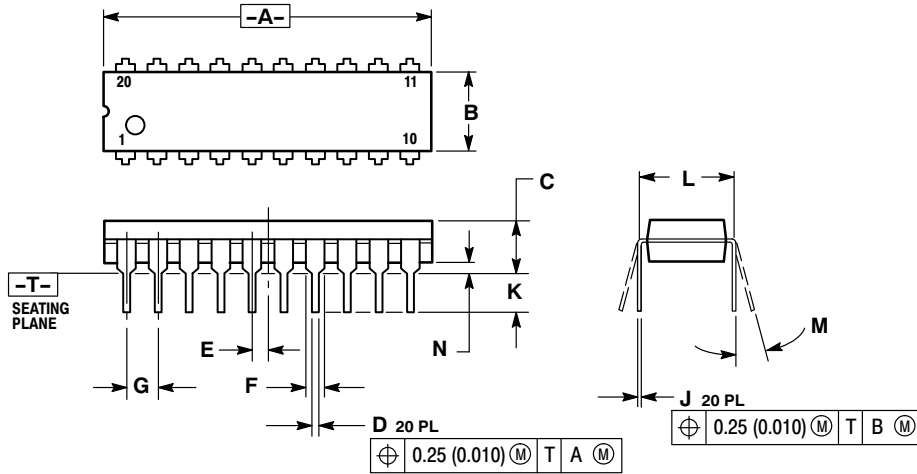

- NOTES:
1. DIMENSIONING AND TOLERANCING PER ANSI Y14.5M, 1982.
 2. CONTROLLING DIMENSION: INCH.
 3. DIMENSION L TO CENTER OF LEAD WHEN FORMED PARALLEL.
 4. DIMENSION B DOES NOT INCLUDE MOLD FLASH.

DIM	INCHES		MILLIMETERS	
	MIN	MAX	MIN	MAX
A	1.010	1.070	25.66	27.17
B	0.240	0.260	6.10	6.60
C	0.150	0.180	3.81	4.57
D	0.015	0.022	0.39	0.55
E	0.050 BSC		1.27 BSC	
F	0.050	0.070	1.27	1.77
G	0.100 BSC		2.54 BSC	
J	0.008	0.015	0.21	0.38
K	0.110	0.140	2.80	3.55
L	0.300 BSC		7.62 BSC	
M	0°	15°	0°	15°
N	0.020	0.040	0.51	1.01

SOIC-20
DW SUFFIX
CASE 751D-05
ISSUE G

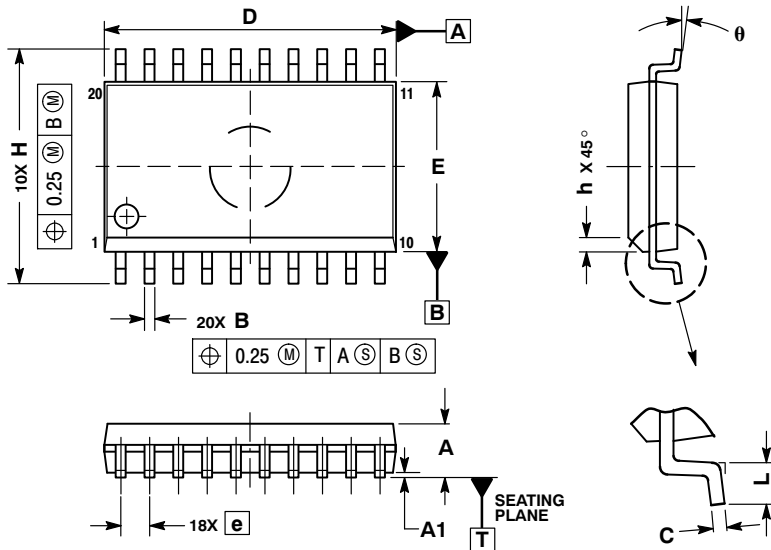

- NOTES:
1. DIMENSIONS ARE IN MILLIMETERS.
 2. INTERPRET DIMENSIONS AND TOLERANCES PER ASME Y14.5M, 1994.
 3. DIMENSIONS D AND E DO NOT INCLUDE MOLD PROTRUSION.
 4. MAXIMUM MOLD PROTRUSION 0.15 PER SIDE.
 5. DIMENSION B DOES NOT INCLUDE DAMBAR PROTRUSION. ALLOWABLE PROTRUSION SHALL BE 0.13 TOTAL IN EXCESS OF B DIMENSION AT MAXIMUM MATERIAL CONDITION.

DIM	MILLIMETERS	
	MIN	MAX
A	2.35	2.65
A1	0.10	0.25
B	0.35	0.49
C	0.23	0.32
D	12.65	12.95
E	7.40	7.60
e	1.27 BSC	
H	10.05	10.55
h	0.25	0.75
L	0.50	0.90
theta	0°	7°