

BFP650

High Linearity Low Noise SiGe:C NPN RF Transistor

Data Sheet

Revision 1.0, 2010-10-22

RF & Protection Devices

Edition 2010-10-22

**Published by
Infineon Technologies AG
81726 Munich, Germany**

**© 2010 Infineon Technologies AG
All Rights Reserved.**

Legal Disclaimer

The information given in this document shall in no event be regarded as a guarantee of conditions or characteristics. With respect to any examples or hints given herein, any typical values stated herein and/or any information regarding the application of the device, Infineon Technologies hereby disclaims any and all warranties and liabilities of any kind, including without limitation, warranties of non-infringement of intellectual property rights of any third party.

Information

For further information on technology, delivery terms and conditions and prices, please contact the nearest Infineon Technologies Office (www.infineon.com).

Warnings

Due to technical requirements, components may contain dangerous substances. For information on the types in question, please contact the nearest Infineon Technologies Office.

Infineon Technologies components may be used in life-support devices or systems only with the express written approval of Infineon Technologies, if a failure of such components can reasonably be expected to cause the failure of that life-support device or system or to affect the safety or effectiveness of that device or system. Life support devices or systems are intended to be implanted in the human body or to support and/or maintain and sustain and/or protect human life. If they fail, it is reasonable to assume that the health of the user or other persons may be endangered.

BFP650, High Linearity Low Noise SiGe:C NPN RF Transistor
Revision History: 2010-10-22, Revision 1.0
Previous Revision:

Page	Subjects (changes since last revision)
	This datasheet replaces the revision from 16 Feb 2009. The product itself has not been changed and the device characteristics remain unchanged. Only the product description and information available in the datasheet have been expanded and updated. The old datasheet revision remains fully valid for those customers who have got the revision from 16 Feb 2009.
2	Typical values for leakage currents included, description of hFE updated.
3	Description of electrical parameters updated.
4, 5	Spice GP model parameters removed from datasheet, updated model parameters shifted to the internet simulation data section.
6	Pulse load curves removed.
7, 8	AC characteristic curves updated.

Trademarks of Infineon Technologies AG

BlueMoon™, COMNEON™, C166™, CROSSAVE™, CanPAK™, CIPOS™, CoolMOS™, CoolSET™, CORECONTROL™, DAVE™, EasyPIM™, EconoBRIDGE™, EconoDUAL™, EconoPACK™, EconoPIM™, EiceDRIVER™, EUPEC™, FCOS™, HITFET™, HybridPACK™, ISOFACE™, I²RF™, IsoPACK™, MIPAQ™, ModSTACK™, my-d™, NovalithIC™, OmniTune™, OptiMOS™, ORIGA™, PROFET™, PRO-SIL™, PRIMARION™, PrimePACK™, RASIC™, ReverSave™, SatRIC™, SensoNor™, SIEGET™, SINDRION™, SMARTi™, SmartLEWIS™, TEMPFET™, thinQ!™, TriCore™, TRENCHSTOP™, X-GOLD™, XMM™, X-PMU™, XPOSYS™.

Other Trademarks

Advance Design System™ (ADS) of Agilent Technologies, AMBA™, ARM™, MULTI-ICE™, PRIMECELL™, REALVIEW™, THUMB™ of ARM Limited, UK. AUTOSAR™ is licensed by AUTOSAR development partnership. Bluetooth™ of Bluetooth SIG Inc. CAT-iq™ of DECT Forum. COLOSSUS™, FirstGPS™ of Trimble Navigation Ltd. EMV™ of EMVCo, LLC (Visa Holdings Inc.). EPCOS™ of Epcos AG. FLEXGO™ of Microsoft Corporation. FlexRay™ is licensed by FlexRay Consortium. HYPERTERMINAL™ of Hilgraeve Incorporated. IEC™ of Commission Electrotechnique Internationale. IrDA™ of Infrared Data Association Corporation. ISO™ of INTERNATIONAL ORGANIZATION FOR STANDARDIZATION. MATLAB™ of MathWorks, Inc. MAXIM™ of Maxim Integrated Products, Inc. MICROTEC™, NUCLEUS™ of Mentor Graphics Corporation. Mifare™ of NXP. MIPI™ of MIPI Alliance, Inc. MIPS™ of MIPS Technologies, Inc., USA. muRata™ of MURATA MANUFACTURING CO., MICROWAVE OFFICE™ (MWO) of Applied Wave Research Inc., OmniVision™ of OmniVision Technologies, Inc. Openwave™ Openwave Systems Inc. RED HAT™ Red Hat, Inc. RFMD™ RF Micro Devices, Inc. SIRIUS™ of Sirius Sattelite Radio Inc. SOLARIS™ of Sun Microsystems, Inc. SPANSION™ of Spansion LLC Ltd. Symbian™ of Symbian Software Limited. TAIYO YUDEN™ of Taiyo Yuden Co. TEAKLITE™ of CEVA, Inc. TEKTRONIX™ of Tektronix Inc. TOKO™ of TOKO KABUSHIKI KAISHA TA. UNIX™ of X/Open Company Limited. VERILOG™, PALLADIUM™ of Cadence Design Systems, Inc. VLYNQ™ of Texas Instruments Incorporated. VXWORKS™, WIND RIVER™ of WIND RIVER SYSTEMS, INC. ZETEX™ of Diodes Zetex Limited.

Last Trademarks Update 2010-03-22

Table of Contents

	Table of Contents	4
	List of Figures	5
	List of Tables	6
1	Features	7
2	Maximum Ratings	8
3	Thermal Characteristics	9
4	Electrical Characteristics	10
4.1	DC Characteristics	10
4.2	General AC Characteristics	10
4.3	Frequency Dependent AC Characteristics	11
4.4	Characteristic DC Diagrams	15
4.5	Characteristic AC Diagrams	18
5	Simulation Data	25
6	Package Information SOT343	26

List of Figures

Figure 1	Total Power Dissipation $P_{\text{tot}} = f(T_s)$	9
Figure 2	BFP650 Testing Circuit.	11
Figure 3	Collector Current vs. Collector Emitter Voltage $I_C = f(V_{CE})$, $I_B = \text{Parameter}$	15
Figure 4	DC Current Gain $h_{FE} = f(I_C)$, $V_{CE} = 3 \text{ V}$	15
Figure 5	Collector Current vs. Base Emitter Voltage $I_C = f(V_{BE})$, $V_{CE} = 2 \text{ V}$	16
Figure 6	Base Current vs. Base Emitter Forward Voltage $I_B = f(V_{BE})$, $V_{CE} = 2 \text{ V}$	16
Figure 7	Base Current vs. Base Emitter Reverse Voltage $I_B = f(V_{EB})$, $V_{CE} = 2 \text{ V}$	17
Figure 8	Transition Frequency $f_T = f(I_C)$, $f = 1 \text{ GHz}$, $V_{CE} = \text{Parameter}$	18
Figure 9	3rd Order Intercept Point $OIP_3 = f(I_C)$, $Z_S = Z_L = 50 \Omega$, V_{CE} , $f = \text{Parameters}$	18
Figure 10	Collector Base Capacitance $C_{CB} = f(V_{CB})$, $f = 1 \text{ MHz}$	19
Figure 11	Gain G_{ma} , G_{ms} , $ S_{21} ^2 = f(f)$, $V_{CE} = 3 \text{ V}$, $I_C = 70 \text{ mA}$	19
Figure 12	Maximum Power Gain $G_{\text{max}} = f(I_C)$, $V_{CE} = 3 \text{ V}$, $f = \text{Parameter in GHz}$	20
Figure 13	Maximum Power Gain $G_{\text{max}} = f(V_{CE})$, $I_C = 70 \text{ mA}$, $f = \text{Parameter in GHz}$	20
Figure 14	Input Matching $S_{11} = f(f)$, $V_{CE} = 3 \text{ V}$, $I_C = 30 / 70 \text{ mA}$	21
Figure 15	Source Impedance for Minimum Noise Figure $Z_{\text{opt}} = f(f)$, $V_{CE} = 3 \text{ V}$, $I_C = 30 / 70 \text{ mA}$	21
Figure 16	Output Matching $S_{22} = f(f)$, $V_{CE} = 3 \text{ V}$, $I_C = 30 / 70 \text{ mA}$	22
Figure 17	Noise Figure $NF_{\text{min}} = f(f)$, $V_{CE} = 3 \text{ V}$, $I_C = 30 / 70 \text{ mA}$, $Z_S = Z_{\text{opt}}$	22
Figure 18	Noise Figure $NF_{\text{min}} = f(I_C)$, $V_{CE} = 3 \text{ V}$, $Z_S = Z_{\text{opt}}$, $f = \text{Parameter in GHz}$	23
Figure 19	Noise Figure $NF_{50} = f(I_C)$, $V_{CE} = 3 \text{ V}$, $Z_S = 50 \Omega$, $f = \text{Parameter in GHz}$	23
Figure 20	Comparison Noise Figure $NF_{50} / NF_{\text{min}} = f(I_C)$, $V_{CE} = 3 \text{ V}$, $f = 2.4 \text{ GHz}$	24
Figure 21	Package Outline	26
Figure 22	Package Foot Print	26
Figure 23	Marking Description (Marking BFP650: R5s)	26
Figure 24	Tape Dimensions	26

List of Tables

Table 1	Maximum Ratings at $T_A = 25^\circ\text{C}$ (unless otherwise specified)	8
Table 2	Thermal Resistance	9
Table 3	DC Characteristics at $T_A = 25^\circ\text{C}$	10
Table 4	General AC Characteristics at $T_A = 25^\circ\text{C}$	10
Table 5	AC Characteristics, $V_{CE} = 3\text{ V}$, $f = 150\text{ MHz}$	11
Table 6	AC Characteristics, $V_{CE} = 3\text{ V}$, $f = 450\text{ MHz}$	11
Table 7	AC Characteristics, $V_{CE} = 3\text{ V}$, $f = 900\text{ MHz}$	12
Table 8	AC Characteristics, $V_{CE} = 3\text{ V}$, $f = 1.5\text{ GHz}$	12
Table 9	AC Characteristics, $V_{CE} = 3\text{ V}$, $f = 1.9\text{ GHz}$	13
Table 10	AC Characteristics, $V_{CE} = 3\text{ V}$, $f = 2.4\text{ GHz}$	13
Table 11	AC Characteristics, $V_{CE} = 3\text{ V}$, $f = 3.5\text{ GHz}$	14
Table 12	AC Characteristics, $V_{CE} = 3\text{ V}$, $f = 5.5\text{ GHz}$	14

1 Features

- Highly linear low noise driver amplifier for all RF frontends up to 4.5 GHz
- Output compression point $OP_{1dB} = 17$ dBm at 70 mA, 3V, 2.4 GHz, 50Ω system
- Output 3rd order intermodulation point $OIP_3 = 30$ dBm at 70 mA, 3 V, 2.4 GHz, 50Ω system
- Maximum available gain $G_{ma} = 17.5$ dB at 70 mA, 3V, 2.4 GHz
- Minimum noise figure $NF_{min} = 1$ dB at 30 mA, 3V, 2.4 GHz
- Based on Infineon's reliable, high volume SiGe:C wafer technology
- Easy to use Pb-free (RoHS compliant) standard package with visible leads
- Qualified according AEC Q101

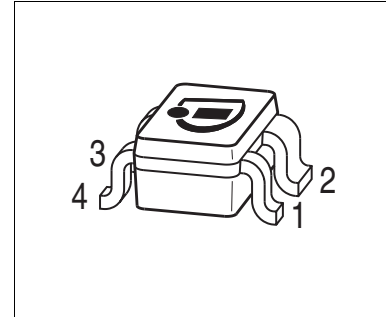

Application Examples

Driver amplifier

- ISM bands 434 and 868 MHz
- 1.9 GHz cordless phones
- CATV LNA

Transmitter driver amplifier

- 2.4 GHz WLAN / Bluetooth, 2.4 / 3.5 GHz WiMAX

Output stage LNA for active antennas

- TV, GPS, SDARS
- 2.4 / 5 GHz WLAN
- 2.4 / 3.5 / 5 GHz WiMAX, etc

Suitable for 5 - 10.5 GHz oscillators

Attention: ESD (Electrostatic discharge) sensitive device, observe handling precautions

Product Name	Package	Pin Configuration				Marking
BFP650	SOT343	1 = B	2 = E	3 = C	4 = E	R5s

2 Maximum Ratings

Table 1 Maximum Ratings at $T_A = 25^\circ\text{C}$ (unless otherwise specified)

Parameter	Symbol	Values		Unit	Note / Test Condition
		Min.	Max.		
Collector emitter voltage	V_{CEO}	–	4.0	V	Open base $T_A = 25^\circ\text{C}$
		–	3.7	V	$T_A = -55^\circ\text{C}$
Collector emitter voltage	V_{CES}	–	13	V	Emitter / base shortened
Collector base voltage	V_{CBO}	–	13	V	Open emitter
Emitter base voltage	V_{EBO}	–	1.2	V	Open collector
Collector current	I_C	–	150	mA	–
Base current	I_B	–	10	mA	–
Total power dissipation ¹⁾	P_{tot}	–	500	mW	$T_S \leq 80^\circ\text{C}$
Junction temperature	T_J	–	150	$^\circ\text{C}$	–
Storage temperature	T_{Stg}	-65	150	$^\circ\text{C}$	–

1) T_S is the soldering point temperature. T_S measured on the emitter lead at the soldering point of the pcb.

Attention: Stresses above the max. values listed here may cause permanent damage to the device. Exposure to absolute maximum rating conditions for extended periods may affect device reliability. Maximum ratings are absolute ratings; exceeding only one of these values may cause irreversible damage to the integrated circuit.

3 Thermal Characteristics

Table 2 Thermal Resistance

Parameter	Symbol	Values			Unit	Note / Test Condition
		Min.	Typ.	Max.		
Junction - soldering point ¹⁾	R_{thJS}	–	–	140	K/W	–

1) For calculation of R_{thJA} please refer to Application Note Thermal Resistance AN077

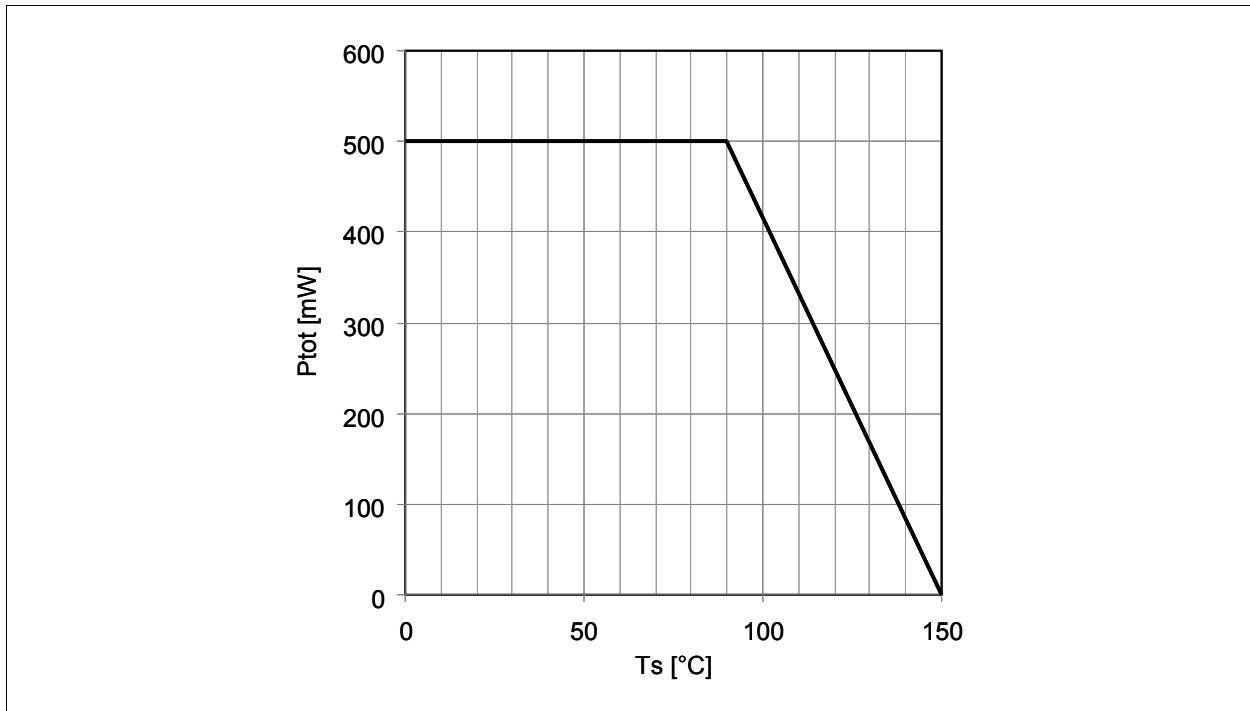

Figure 1 Total Power Dissipation $P_{tot} = f(T_s)$

4 Electrical Characteristics

4.1 DC Characteristics

Table 3 DC Characteristics at $T_A = 25\text{ }^\circ\text{C}$

Parameter	Symbol	Values			Unit	Note / Test Condition
		Min.	Typ.	Max.		
Collector emitter breakdown voltage	$V_{(BR)CEO}$	4	4.5	–	V	$I_C = 3\text{ mA}$, $I_B = 0$ Open base
Collector emitter leakage current	I_{CES}	–	–	100	μA	$V_{CE} = 13\text{ V}$, $V_{BE} = 0$
		–	1	40	nA	$V_{CE} = 5\text{ V}$, $V_{BE} = 0$ Emitter/base shortened
Collector base leakage current	I_{CBO}	–	1	40	nA	$V_{CB} = 5\text{ V}$, $I_E = 0$ Open emitter
Emitter base leakage current	I_{EBO}	–	0.01	3	μA	$V_{EB} = 0.5\text{ V}$, $I_C = 0$ Open collector
DC current gain	h_{FE}	100	170	250		$V_{CE} = 3\text{ V}$, $I_C = 70\text{ mA}$ Pulse measured

4.2 General AC Characteristics

Table 4 General AC Characteristics at $T_A = 25\text{ }^\circ\text{C}$

Parameter	Symbol	Values			Unit	Note / Test Condition
		Min.	Typ.	Max.		
Transition frequency	f_T	31	41	–	GHz	$V_{CE} = 3\text{ V}$, $I_C = 70\text{ mA}$, $f = 1\text{ GHz}$
Collector base capacitance	C_{CB}	–	0.26	0.4	pF	$V_{CB} = 3\text{ V}$, $V_{BE} = 0\text{ V}$ $f = 1\text{ MHz}$ Emitter grounded
Collector emitter capacitance	C_{CE}	–	0.45	–	pF	$V_{CE} = 3\text{ V}$, $V_{BE} = 0\text{ V}$ $f = 1\text{ MHz}$ Base grounded
Emitter base capacitance	C_{EB}	–	1.3	–	pF	$V_{EB} = 0.5\text{ V}$, $V_{CB} = 0\text{ V}$ $f = 1\text{ MHz}$ Collector grounded

4.3 Frequency Dependent AC Characteristics

Measurement setup is a test fixture with Bias T's in a 50 Ω system, $T_A = 25\text{ °C}$

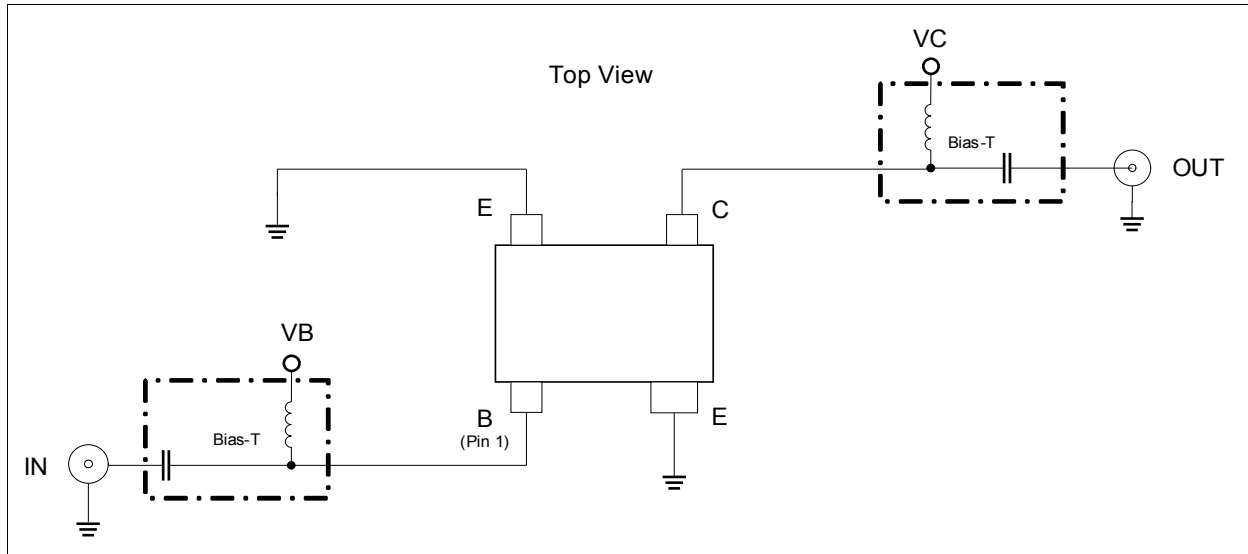

Figure 2 BFP650 Testing Circuit

Table 5 AC Characteristics, $V_{CE} = 3\text{ V}$, $f = 150\text{ MHz}$

Parameter	Symbol	Values			Unit	Note / Test Condition
		Min.	Typ.	Max.		
Maximum power gain					dB	
High linearity operation point	G_{ms}	–	35.5	–		$I_C = 30\text{ mA}$
Class A operation point	G_{ms}	–	38	–		$I_C = 70\text{ mA}$
Transducer gain					dB	$Z_S = Z_L = 50\text{ }\Omega$
High linearity operation point	S_{21}	–	35	–		$I_C = 30\text{ mA}$
Class A operation point	S_{21}	–	37.5	–		$I_C = 70\text{ mA}$
Minimum noise figure					dB	$Z_S = Z_{opt}$
Minimum noise figure	NF_{min}	–	0.75	–		$I_C = 30\text{ mA}$
Associated gain	G_{ass}	–	32	–		$I_C = 30\text{ mA}$
Linearity					dBm	$Z_S = Z_L = 50\text{ }\Omega$
1 dB gain compression point	OP_{1dB}	–	16.5	–		$I_C = 70\text{ mA}$
3rd order intercept point	OIP_3	–	29.5	–		$I_C = 70\text{ mA}$

Table 6 AC Characteristics, $V_{CE} = 3\text{ V}$, $f = 450\text{ MHz}$

Parameter	Symbol	Values			Unit	Note / Test Condition
		Min.	Typ.	Max.		
Maximum power gain					dB	
High linearity operation point	G_{ms}	–	30	–		$I_C = 30\text{ mA}$
Class A operation point	G_{ms}	–	31.5	–		$I_C = 70\text{ mA}$

Table 6 AC Characteristics, $V_{CE} = 3\text{ V}$, $f = 450\text{ MHz}$ (cont'd)

Parameter	Symbol	Values			Unit	Note / Test Condition
		Min.	Typ.	Max.		
Transducer gain					dB	$Z_S = Z_L = 50\ \Omega$
High linearity operation point	S_{21}	–	29	–		$I_C = 30\text{ mA}$
Class A operation point	S_{21}	–	29.5	–		$I_C = 70\text{ mA}$
Minimum noise figure					dB	$Z_S = Z_{opt}$
Minimum noise figure	NF_{min}	–	0.75	–		$I_C = 30\text{ mA}$
Associated gain	G_{ass}	–	29.5	–		$I_C = 30\text{ mA}$
Linearity					dBm	$Z_S = Z_L = 50\ \Omega$
1 dB gain compression point	OP_{1dB}	–	16.5	–		$I_C = 70\text{ mA}$
3rd order intercept point	OIP_3	–	30	–		$I_C = 70\text{ mA}$

Table 7 AC Characteristics, $V_{CE} = 3\text{ V}$, $f = 900\text{ MHz}$

Parameter	Symbol	Values			Unit	Note / Test Condition
		Min.	Typ.	Max.		
Maximum power gain					dB	
High linearity operation point	G_{ms}	–	25.5	–		$I_C = 30\text{ mA}$
Class A operation point	G_{ms}	–	26.5	–		$I_C = 70\text{ mA}$
Transducer gain					dB	$Z_S = Z_L = 50\ \Omega$
High linearity operation point	S_{21}	–	23.5	–		$I_C = 30\text{ mA}$
Class A operation point	S_{21}	–	24	–		$I_C = 70\text{ mA}$
Minimum noise figure					dB	$Z_S = Z_{opt}$
Minimum noise figure	NF_{min}	–	0.8	–		$I_C = 30\text{ mA}$
Associated gain	G_{ass}	–	24.5	–		$I_C = 30\text{ mA}$
Linearity					dBm	$Z_S = Z_L = 50\ \Omega$
1 dB gain compression point	OP_{1dB}	–	17	–		$I_C = 70\text{ mA}$
3rd order intercept point	OIP_3	–	31	–		$I_C = 70\text{ mA}$

Table 8 AC Characteristics, $V_{CE} = 3\text{ V}$, $f = 1.5\text{ GHz}$

Parameter	Symbol	Values			Unit	Note / Test Condition
		Min.	Typ.	Max.		
Maximum power gain					dB	
High linearity operation point	G_{ms}	–	22	–		$I_C = 30\text{ mA}$
Class A operation point	G_{ms}	–	22.5	–		$I_C = 70\text{ mA}$
Transducer gain					dB	$Z_S = Z_L = 50\ \Omega$
High linearity operation point	S_{21}	–	19	–		$I_C = 30\text{ mA}$
Class A operation point	S_{21}	–	19.5	–		$I_C = 70\text{ mA}$
Minimum noise figure					dB	$Z_S = Z_{opt}$
Minimum noise figure	NF_{min}	–	0.85	–		$I_C = 30\text{ mA}$

Electrical Characteristics
Table 8 AC Characteristics, $V_{CE} = 3\text{ V}$, $f = 1.5\text{ GHz}$ (cont'd)

Parameter	Symbol	Values			Unit	Note / Test Condition
		Min.	Typ.	Max.		
Associated gain	G_{ass}	–	20.5	–		$I_C = 30\text{ mA}$
Linearity					dBm	$Z_S = Z_L = 50\ \Omega$ $I_C = 70\text{ mA}$
1 dB gain compression point	$OP_{1\text{dB}}$	–	17	–		
3rd order intercept point	OIP_3	–	31	–		

Table 9 AC Characteristics, $V_{CE} = 3\text{ V}$, $f = 1.9\text{ GHz}$

Parameter	Symbol	Values			Unit	Note / Test Condition
		Min.	Typ.	Max.		
Maximum power gain					dB	$I_C = 30\text{ mA}$ $I_C = 70\text{ mA}$
High linearity operation point	G_{ma}	–	20.5	–		
Class A operation point	G_{ms}	–	20	–		
Transducer gain					dB	$Z_S = Z_L = 50\ \Omega$ $I_C = 30\text{ mA}$ $I_C = 70\text{ mA}$
High linearity operation point	S_{21}	–	17	–		
Class A operation point	S_{21}	15	17.5	–		
Minimum noise figure					dB	$Z_S = Z_{\text{opt}}$ $I_C = 30\text{ mA}$ $I_C = 30\text{ mA}$
Minimum noise figure	NF_{min}	–	0.95	–		
Associated gain	G_{ass}	–	17.5	–		
Linearity					dBm	$Z_S = Z_L = 50\ \Omega$ $I_C = 70\text{ mA}$ $I_C = 70\text{ mA}$
1 dB gain compression point	$OP_{1\text{dB}}$	–	17	–		
3rd order intercept point	OIP_3	–	30.5	–		

Table 10 AC Characteristics, $V_{CE} = 3\text{ V}$, $f = 2.4\text{ GHz}$

Parameter	Symbol	Values			Unit	Note / Test Condition
		Min.	Typ.	Max.		
Maximum power gain					dB	$I_C = 30\text{ mA}$ $I_C = 70\text{ mA}$
High linearity operation point	G_{ma}	–	18	–		
Class A operation point	G_{ma}	–	17.5	–		
Transducer gain					dB	$Z_S = Z_L = 50\ \Omega$ $I_C = 30\text{ mA}$ $I_C = 70\text{ mA}$
High linearity operation point	S_{21}	–	14.5	–		
Class A operation point	S_{21}	–	15	–		
Minimum noise figure					dB	$Z_S = Z_{\text{opt}}$ $I_C = 30\text{ mA}$ $I_C = 30\text{ mA}$
Minimum noise figure	NF_{min}	–	1	–		
Associated gain	G_{ass}	–	15	–		
Linearity					dBm	$Z_S = Z_L = 50\ \Omega$ $I_C = 70\text{ mA}$ $I_C = 70\text{ mA}$
1 dB gain compression point	$OP_{1\text{dB}}$	–	17	–		
3rd order intercept point	OIP_3	–	30	–		

Table 11 AC Characteristics, $V_{CE} = 3\text{ V}$, $f = 3.5\text{ GHz}$

Parameter	Symbol	Values			Unit	Note / Test Condition
		Min.	Typ.	Max.		
Maximum power gain					dB	
High linearity operation point	G_{ma}	–	14	–		$I_C = 30\text{ mA}$
Class A operation point	G_{ma}	–	14.5	–		$I_C = 70\text{ mA}$
Transducer gain					dB	$Z_S = Z_L = 50\ \Omega$
High linearity operation point	S_{21}	–	11	–		$I_C = 30\text{ mA}$
Class A operation point	S_{21}	–	11.5	–		$I_C = 70\text{ mA}$
Minimum noise figure					dB	$Z_S = Z_{opt}$
Minimum noise figure	NF_{min}	–	1.2	–		$I_C = 30\text{ mA}$
Associated gain	G_{ass}	–	11.5	–		$I_C = 30\text{ mA}$
Linearity					dBm	$Z_S = Z_L = 50\ \Omega$
1 dB gain compression point	OP_{1dB}	–	17	–		$I_C = 70\text{ mA}$
3rd order intercept point	OIP_3	–	30	–		$I_C = 70\text{ mA}$

Table 12 AC Characteristics, $V_{CE} = 3\text{ V}$, $f = 5.5\text{ GHz}$

Parameter	Symbol	Values			Unit	Note / Test Condition
		Min.	Typ.	Max.		
Maximum power gain					dB	
High linearity operation point	G_{ma}	–	10.5	–		$I_C = 30\text{ mA}$
Class A operation point	G_{ma}	–	10.5	–		$I_C = 70\text{ mA}$
Transducer gain					dB	$Z_S = Z_L = 50\ \Omega$
High linearity operation point	S_{21}	–	6.5	–		$I_C = 30\text{ mA}$
Class A operation point	S_{21}	–	7	–		$I_C = 70\text{ mA}$
Minimum noise figure					dB	$Z_S = Z_{opt}$
Minimum noise figure	NF_{min}	–	1.6	–		$I_C = 30\text{ mA}$
Associated gain	G_{ass}	–	8.5	–		$I_C = 30\text{ mA}$
Linearity					dBm	$Z_S = Z_L = 50\ \Omega$
1 dB gain compression point	OP_{1dB}	–	16.5	–		$I_C = 70\text{ mA}$
3rd order intercept point	OIP_3	–	29.5	–		$I_C = 70\text{ mA}$

Note:

1. AC parameter limits verified by random sampling.
2. In order to get the NF_{min} values stated in this chapter the test fixture losses have been subtracted from all measured result.
3. OIP_3 value depends on termination of all intermodulation frequency components. Termination used for this measurement is $50\ \Omega$ from 0.2 MHz to 12 GHz.

4.4 Characteristic DC Diagrams

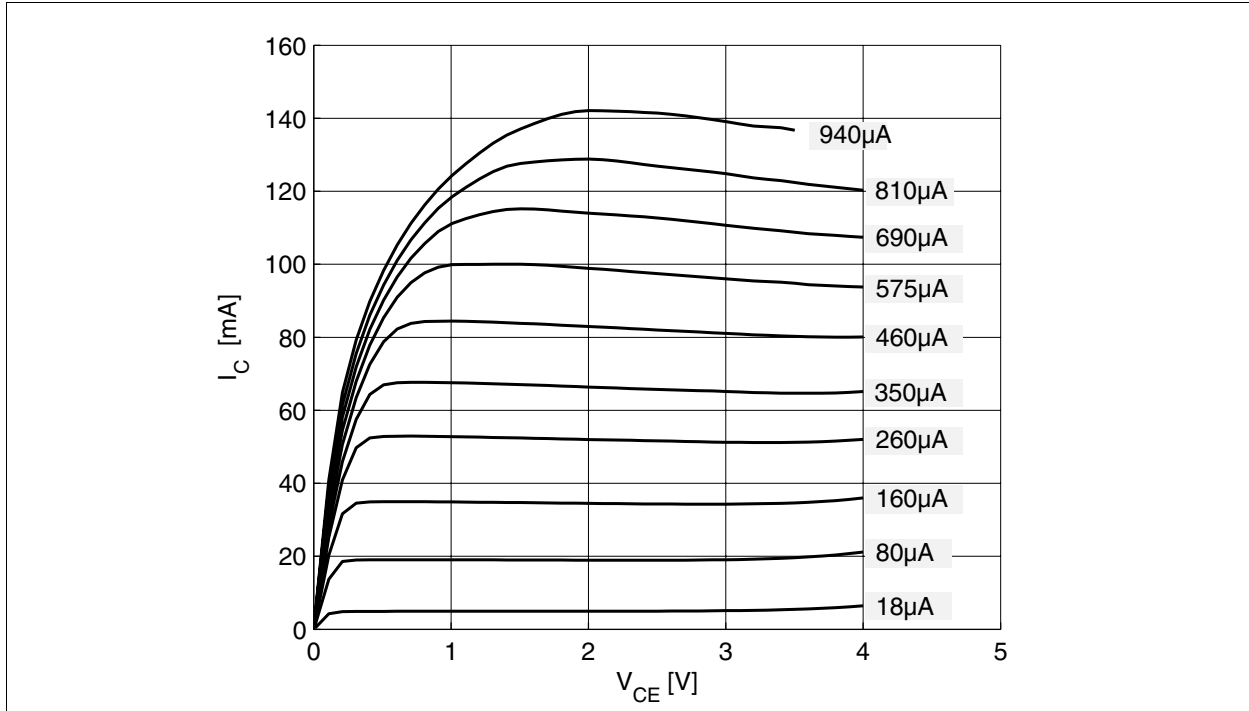

Figure 3 Collector Current vs. Collector Emitter Voltage $I_C = f(V_{CE})$, $I_B = \text{Parameter}$

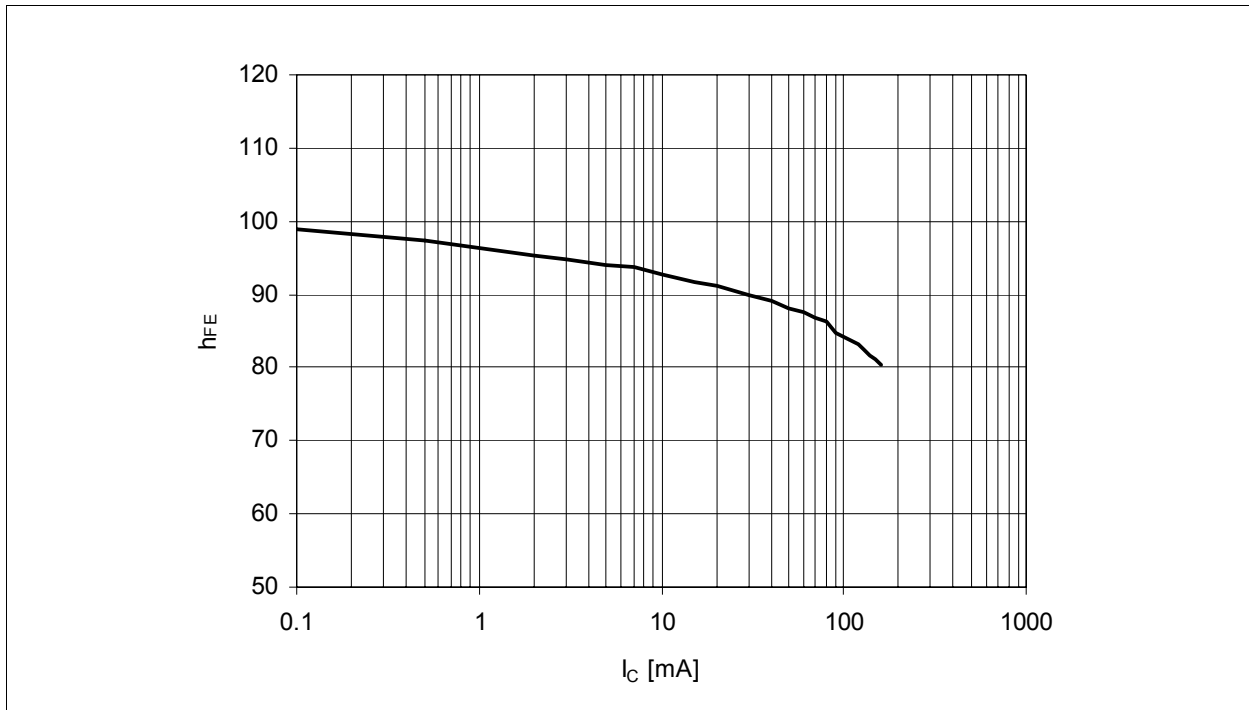

Figure 4 DC Current Gain $h_{FE} = f(I_C)$, $V_{CE} = 3 \text{ V}$

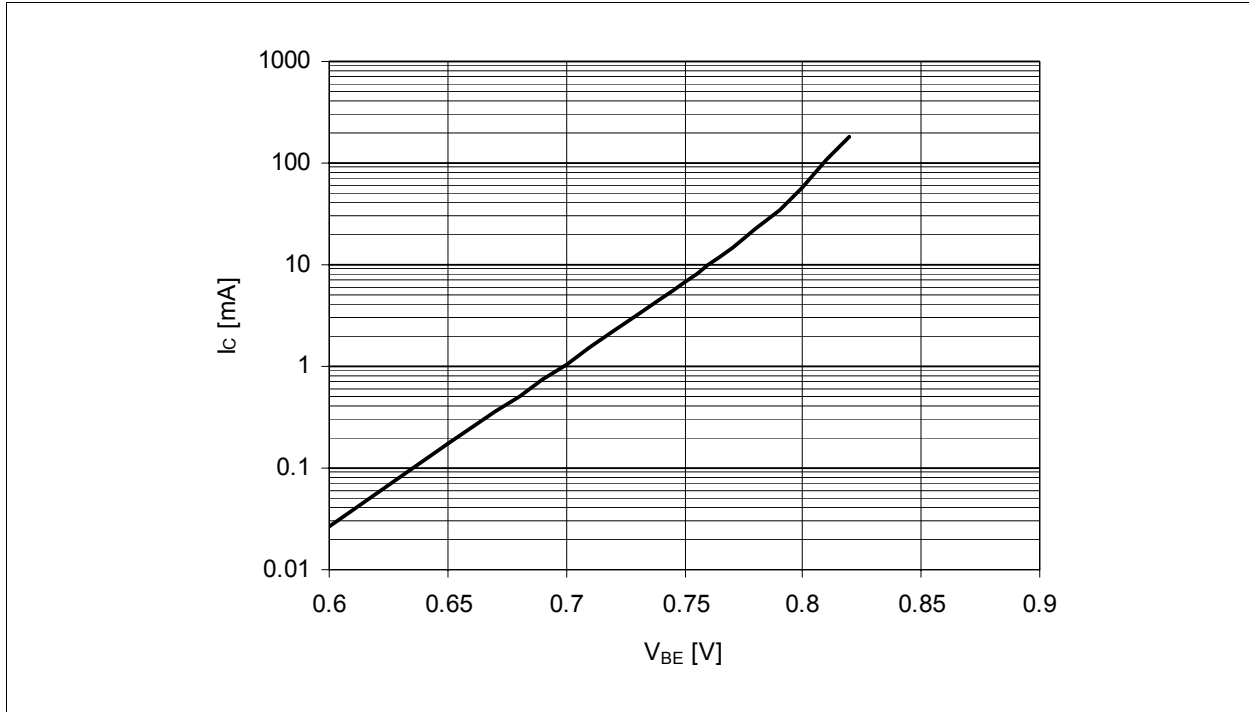

Figure 5 Collector Current vs. Base Emitter Voltage $I_C = f(V_{BE})$, $V_{CE} = 2\text{ V}$

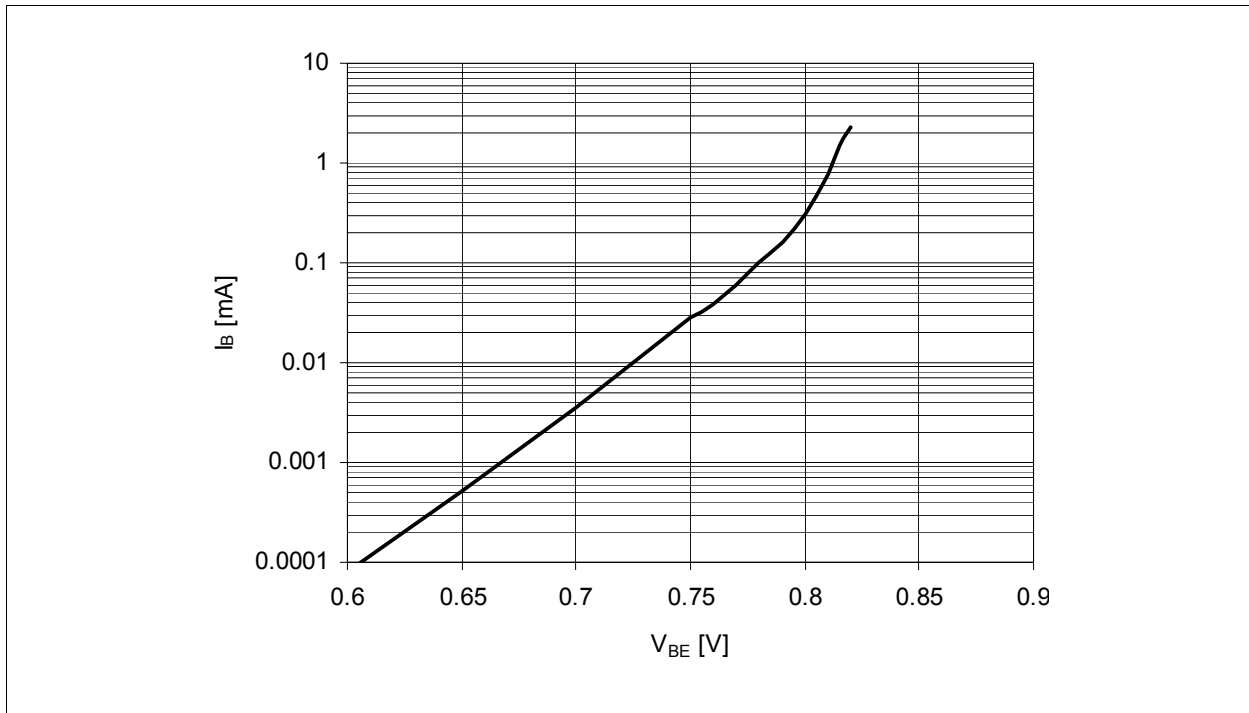

Figure 6 Base Current vs. Base Emitter Forward Voltage $I_B = f(V_{BE})$, $V_{CE} = 2\text{ V}$

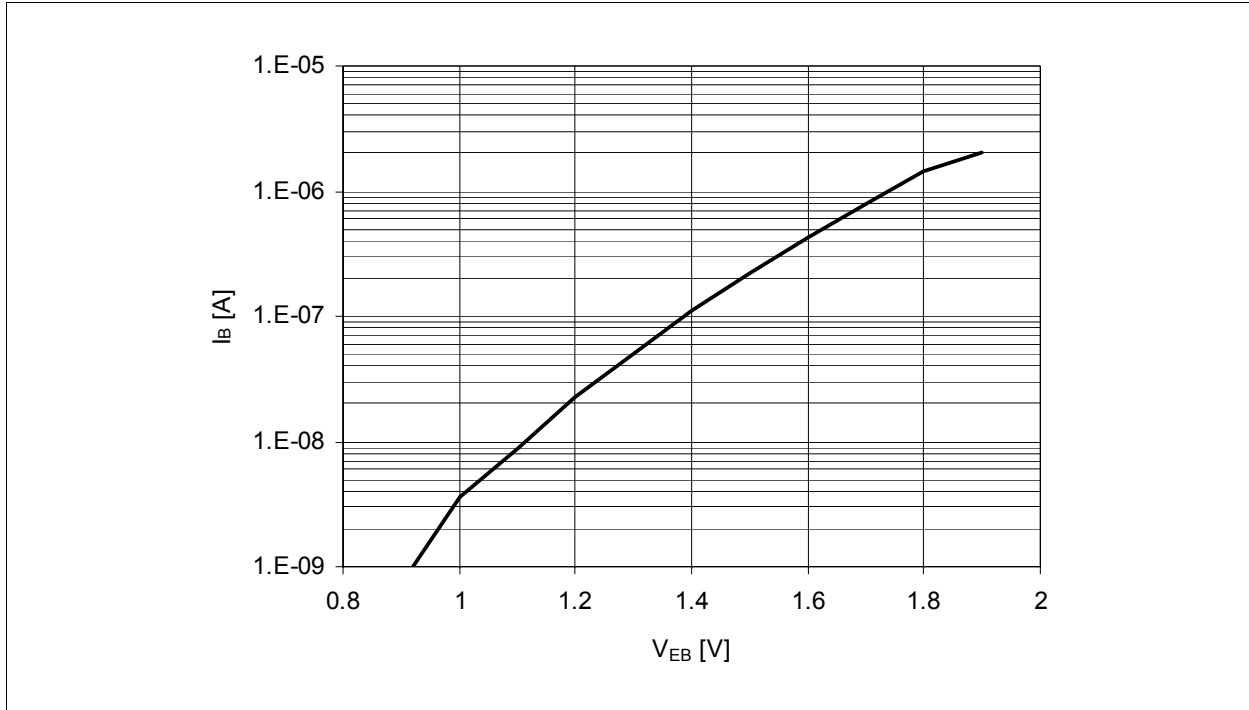

Figure 7 Base Current vs. Base Emitter Reverse Voltage $I_B = f(V_{EB}), V_{CE} = 2\text{ V}$

4.5 Characteristic AC Diagrams

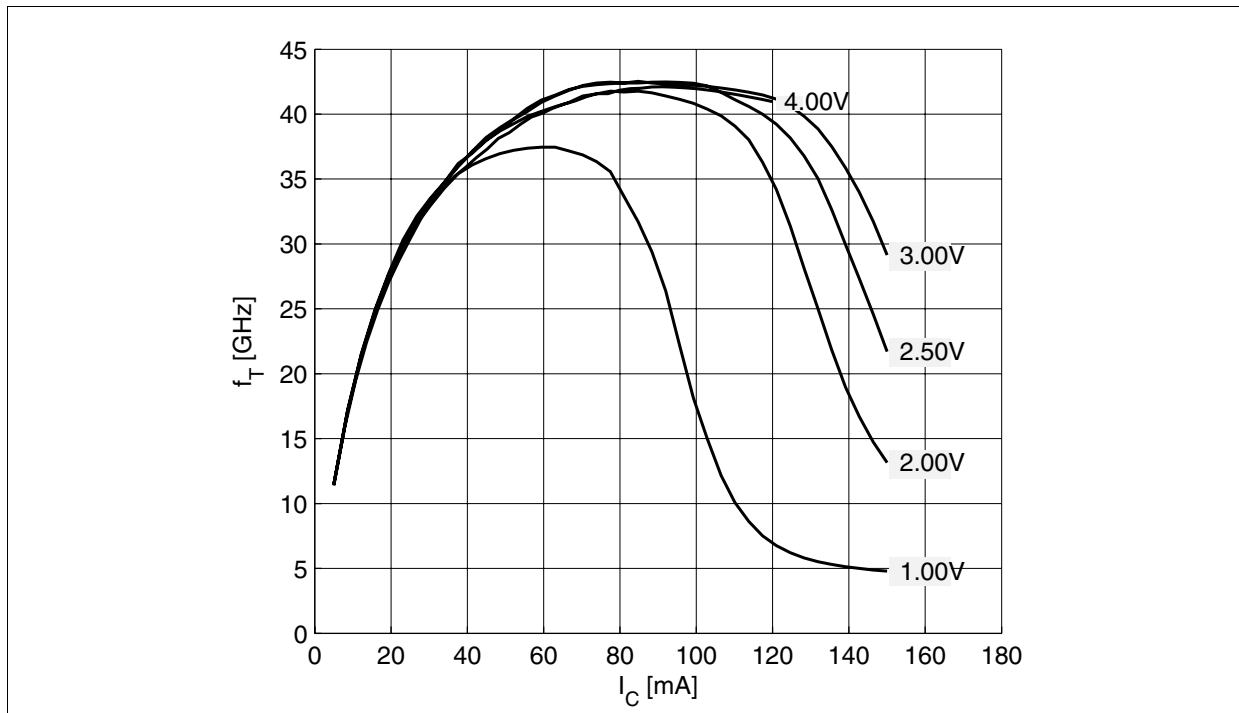

Figure 8 Transition Frequency $f_T = f(I_C)$, $f = 1 \text{ GHz}$, $V_{CE} = \text{Parameter}$

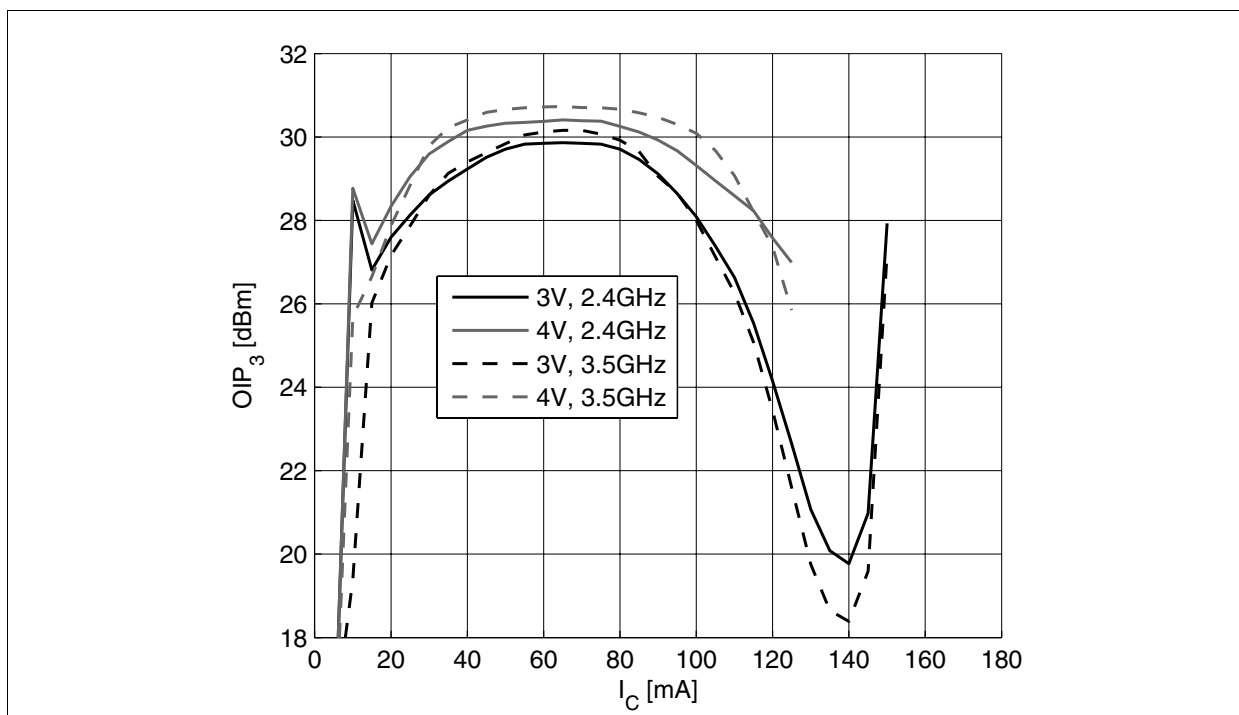

Figure 9 3rd Order Intercept Point $OIP_3 = f(I_C)$, $Z_S = Z_L = 50 \Omega$, $V_{CE}, f = \text{Parameters}$

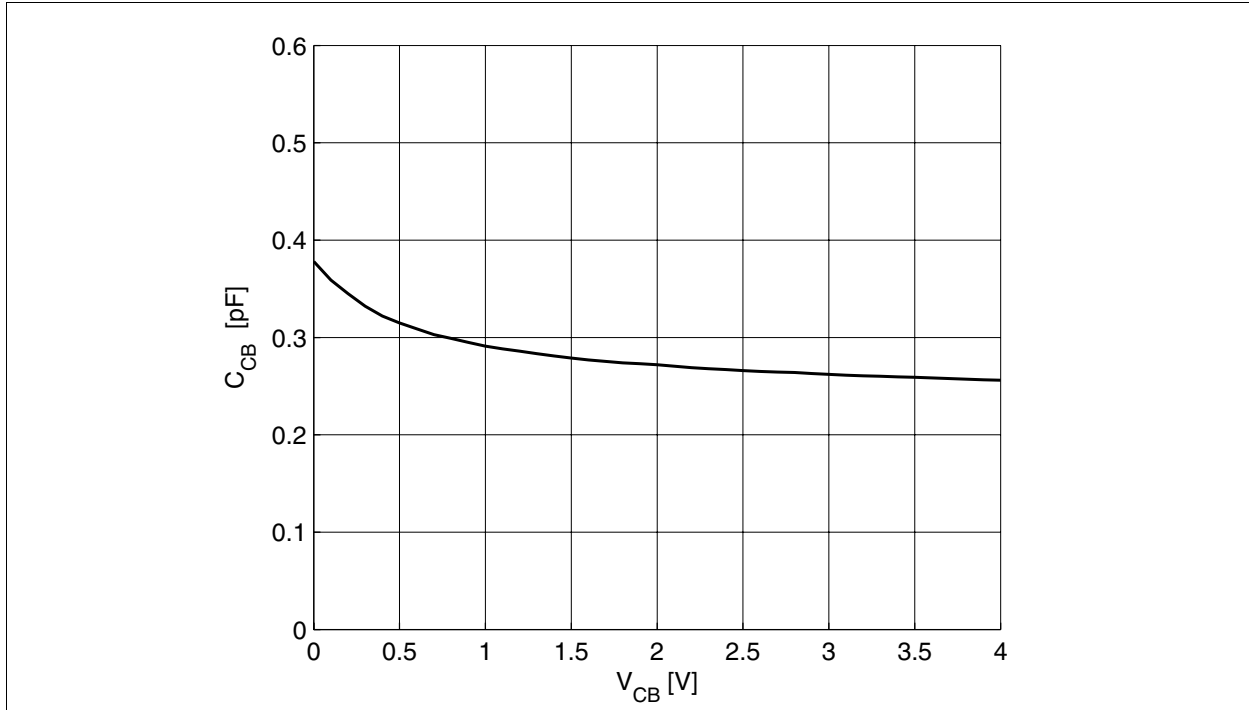

Figure 10 Collector Base Capacitance $C_{CB} = f(V_{CB})$, $f = 1$ MHz

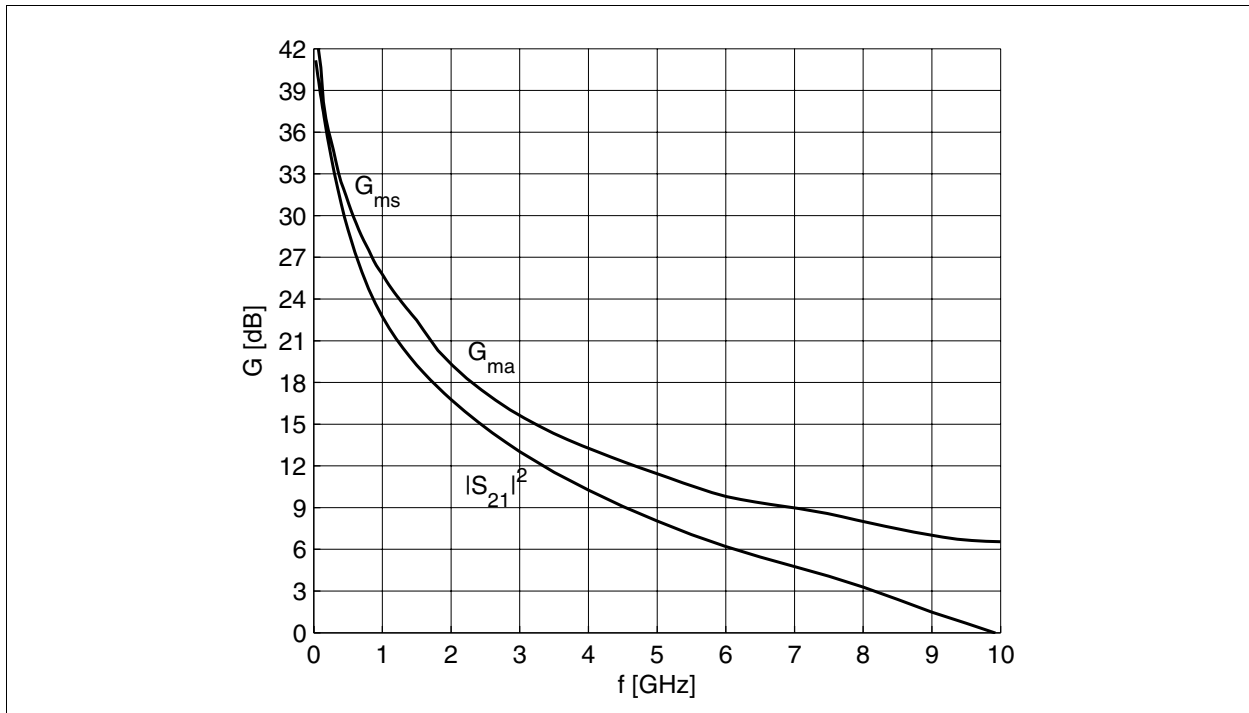

Figure 11 Gain G_{ma} , G_{ms} , $|S_{21}|^2 = f(f)$, $V_{CE} = 3$ V, $I_C = 70$ mA

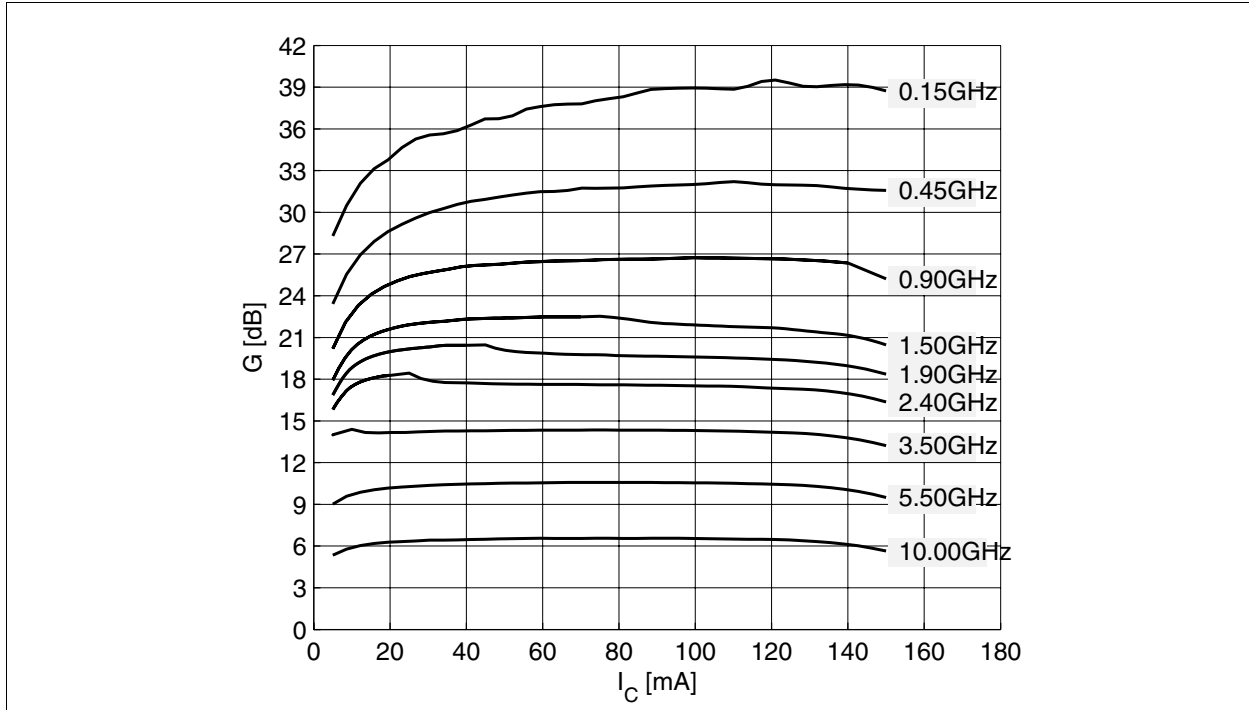

Figure 12 Maximum Power Gain $G_{max} = f(I_C)$, $V_{CE} = 3\text{ V}$, $f = \text{Parameter in GHz}$

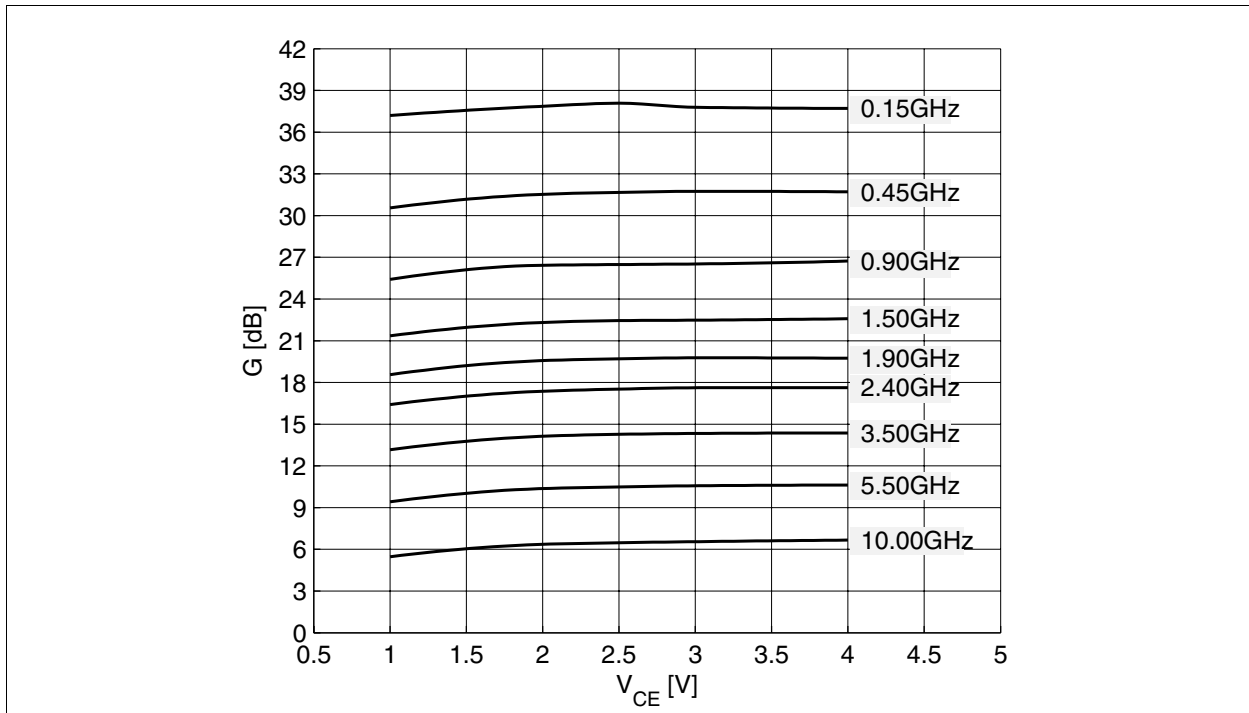

Figure 13 Maximum Power Gain $G_{max} = f(V_{CE})$, $I_C = 70\text{ mA}$, $f = \text{Parameter in GHz}$

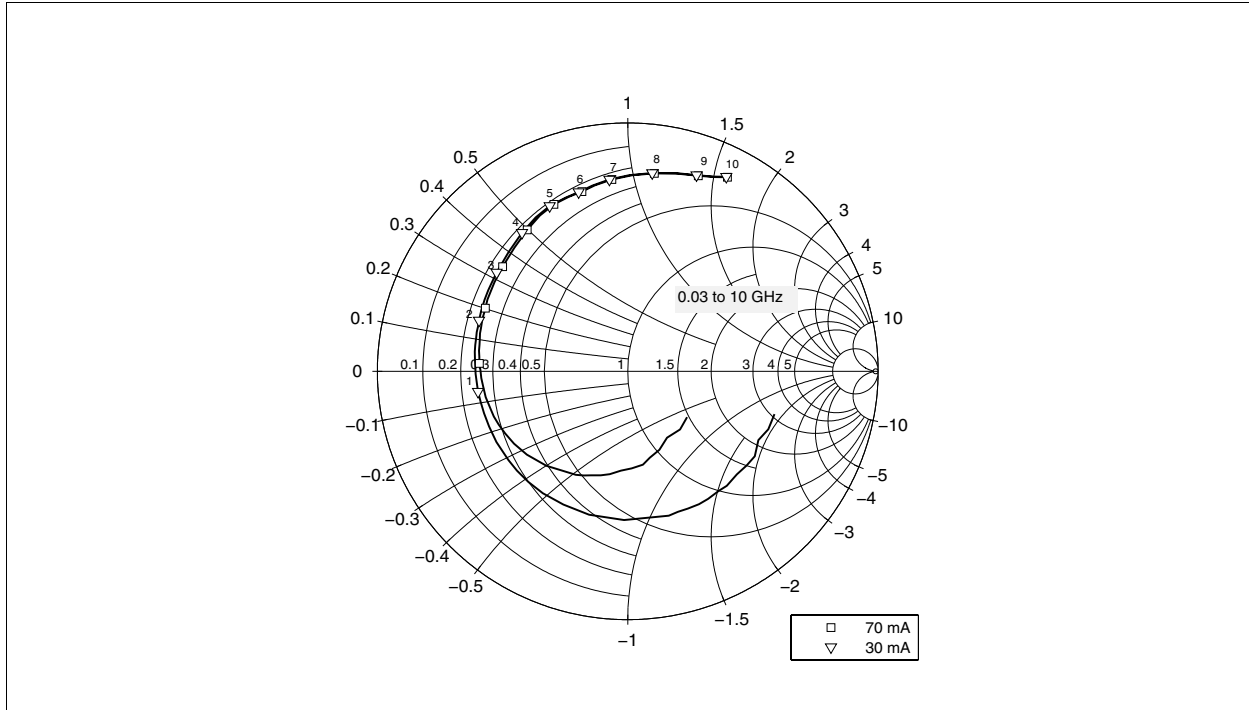

Figure 14 Input Matching $S_{11} = f(f)$, $V_{CE} = 3\text{ V}$, $I_C = 30 / 70\text{ mA}$

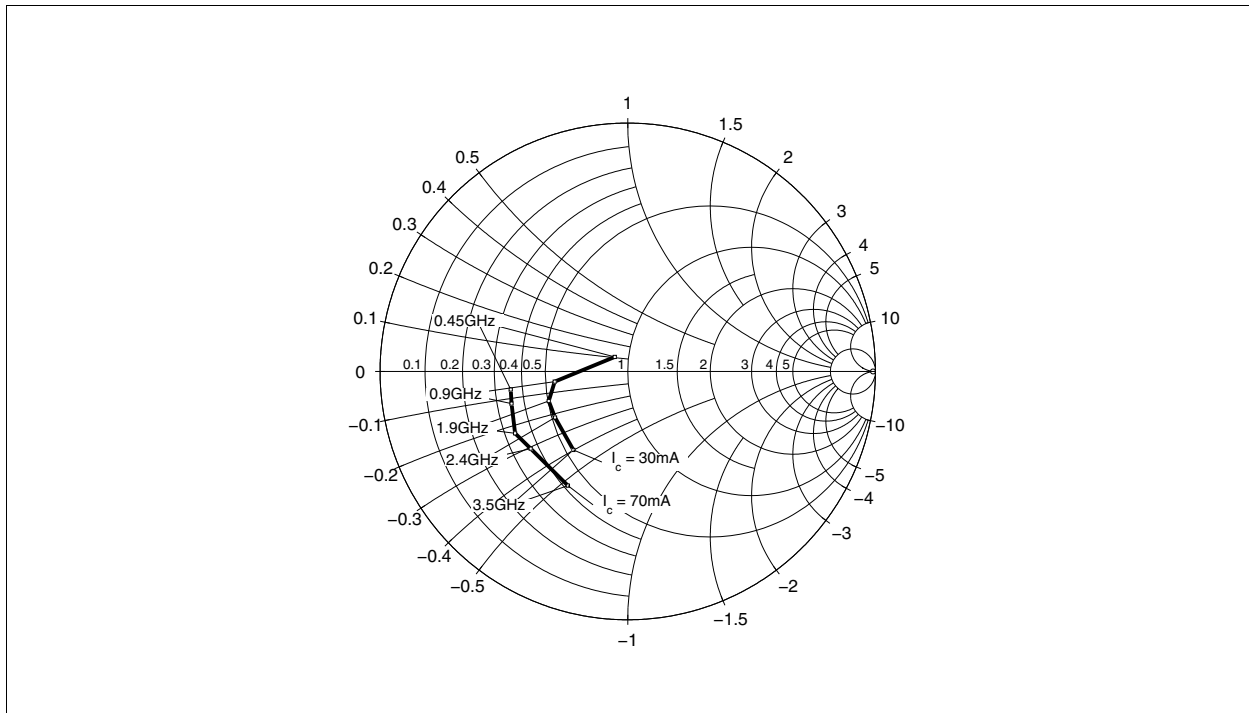

Figure 15 Source Impedance for Minimum Noise Figure $Z_{opt} = f(f)$, $V_{CE} = 3\text{ V}$, $I_C = 30 / 70\text{ mA}$

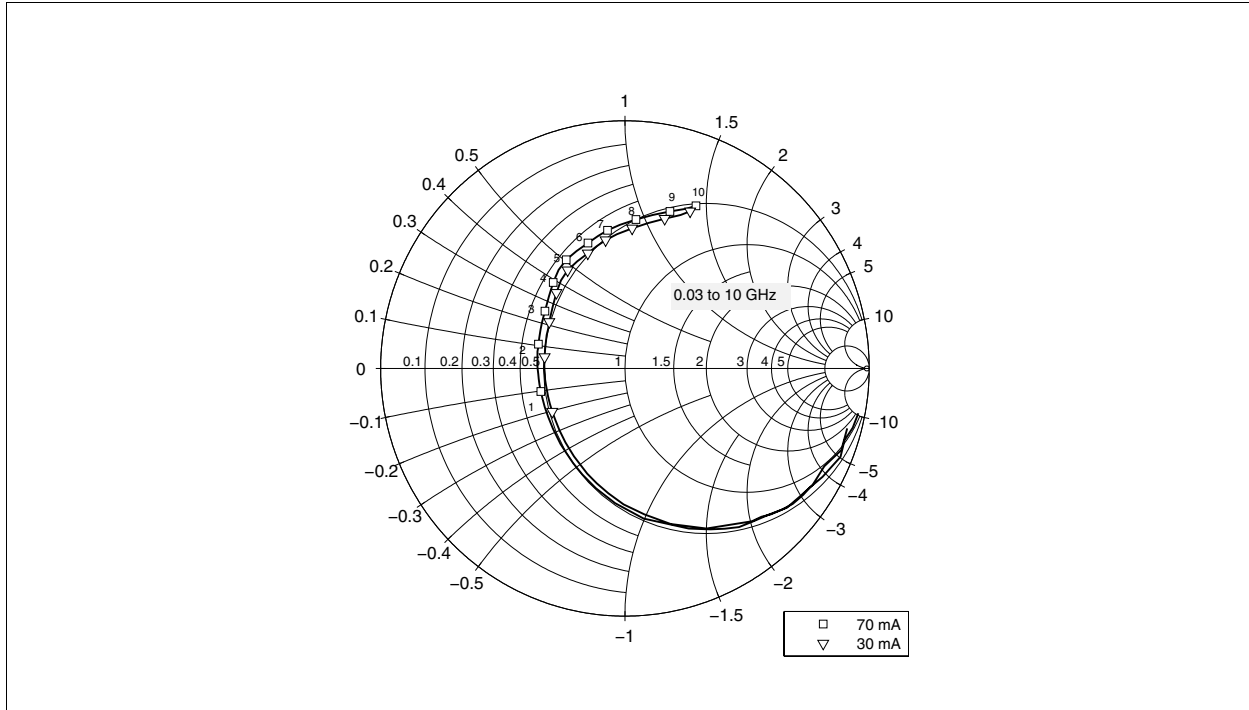

Figure 16 Output Matching $S_{22} = f(f)$, $V_{CE} = 3\text{ V}$, $I_C = 30 / 70\text{ mA}$

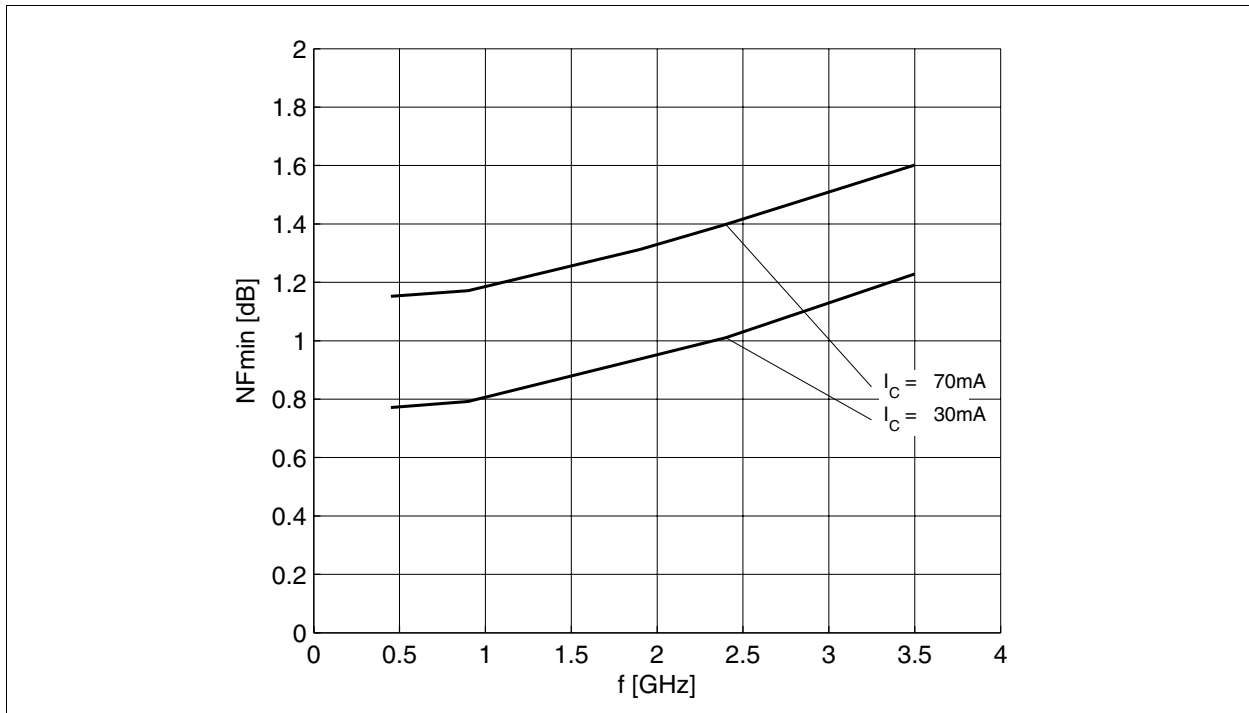

Figure 17 Noise Figure $NF_{min} = f(f)$, $V_{CE} = 3\text{ V}$, $I_C = 30 / 70\text{ mA}$, $Z_S = Z_{opt}$

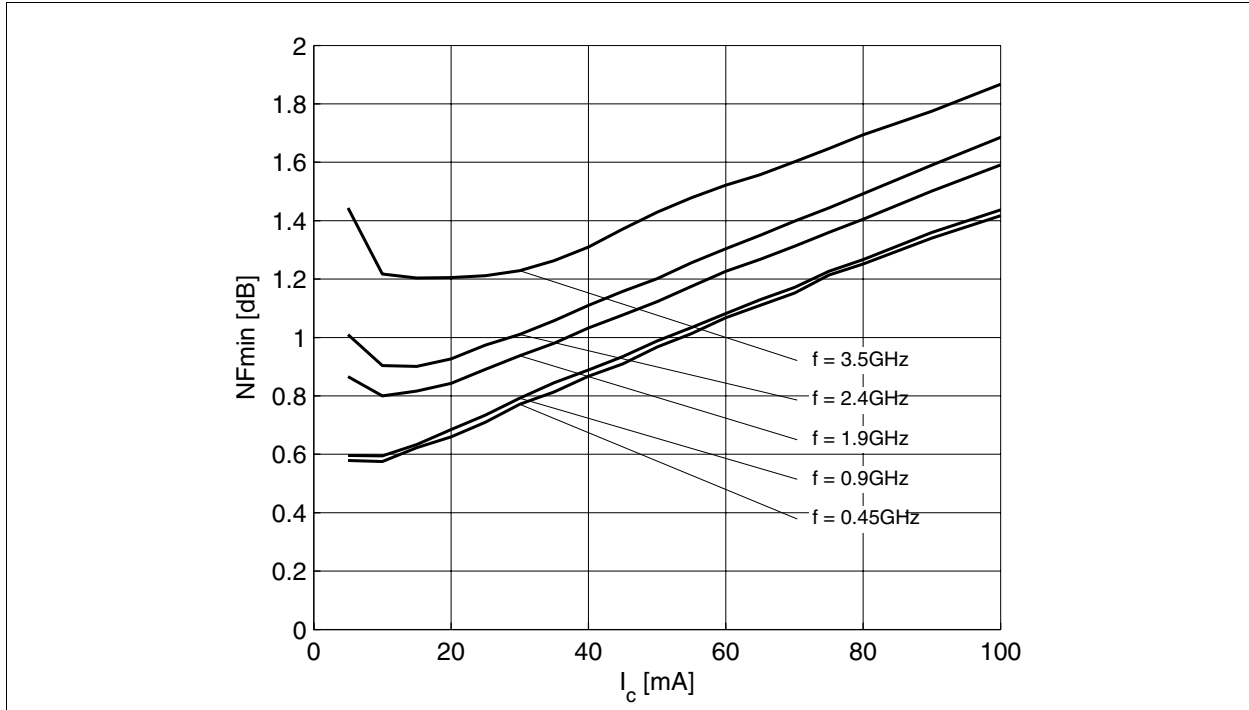

Figure 18 Noise Figure $NF_{min} = f(I_C)$, $V_{CE} = 3\text{ V}$, $Z_S = Z_{opt}$, $f = \text{Parameter in GHz}$

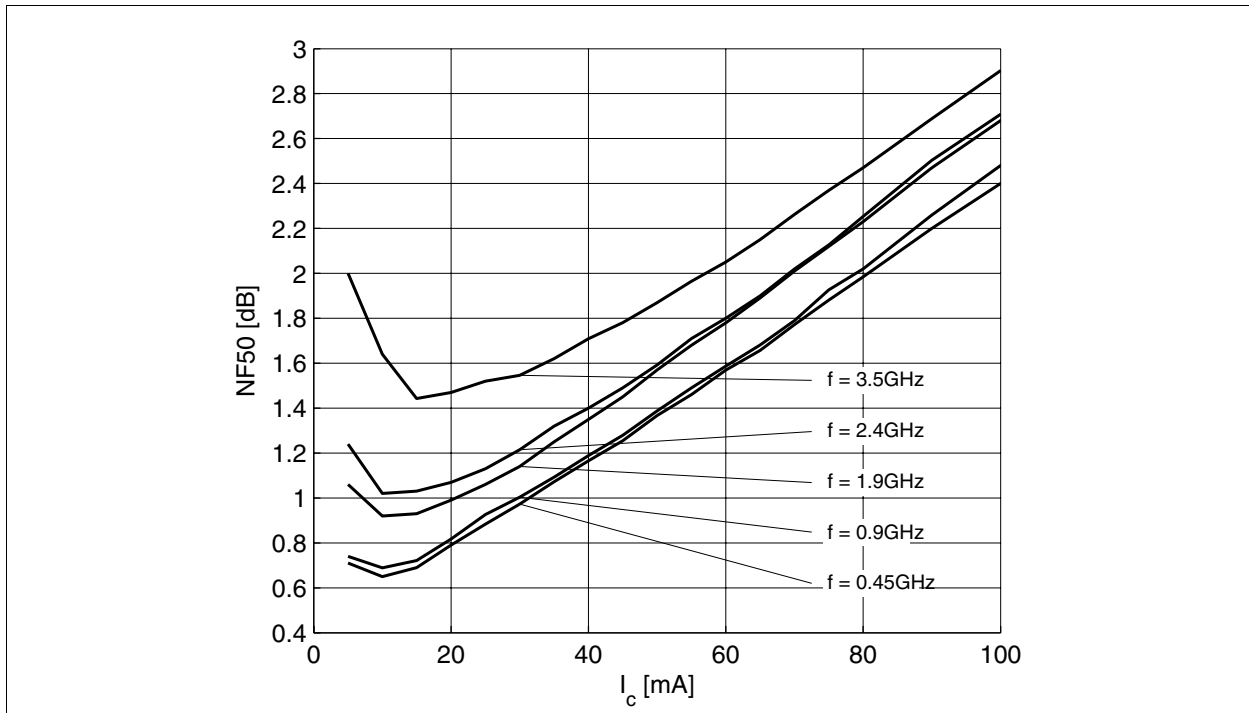

Figure 19 Noise Figure $NF_{50} = f(I_C)$, $V_{CE} = 3\text{ V}$, $Z_S = 50\ \Omega$, $f = \text{Parameter in GHz}$

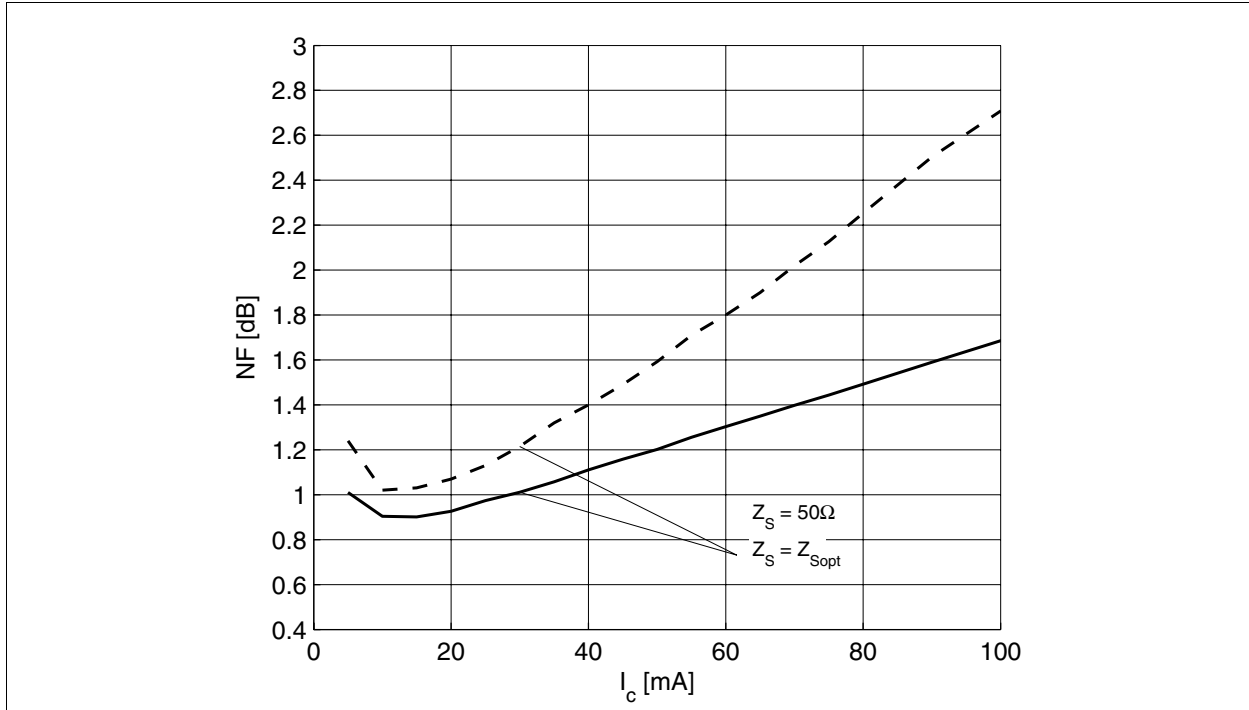

Figure 20 Comparison Noise Figure NF_{50} / $NF_{min} = f(I_C)$, $V_{CE} = 3\text{ V}$, $f = 2.4\text{ GHz}$

Note: The curves shown in this chapter have been generated using typical devices but shall not be considered as a guarantee that all devices have identical characteristic curves. $T_A = 25^\circ\text{C}$.

5 Simulation Data

For the SPICE Gummel Poon (GP) model as well as for the S-parameters (including noise parameters) please refer to our internet website: www.infineon.com/rf.models. Please consult our website and download the latest versions before actually starting your design.

You find the BFP650 SPICE GP model in the internet in MWO- and ADS-format, which you can import into these circuit simulation tools very quickly and conveniently. The model already contains the package parasitics and is ready to use for DC- and high frequency simulations. The terminals of the model circuit correspond to the pin configuration of the device.

The model parameters have been extracted and verified up to 10 GHz using typical devices. The BFP650 SPICE GP model reflects the typical DC- and RF-performance within the limitations which are given by the SPICE GP model itself.

www.infineon.com

Published by Infineon Technologies AG