

LM2904, LM358/LM358A, LM258/ LM258A

Dual Operational Amplifier

Features

- Internally Frequency Compensated for Unity Gain
- Large DC Voltage Gain: 100dB
- Wide Power Supply Range:
LM258/LM258A, LM358/LM358A: 3V~32V (or $\pm 1.5V \sim 16V$)
LM2904 : 3V~26V (or $\pm 1.5V \sim 13V$)
- Input Common Mode Voltage Range Includes Ground
- Large Output Voltage Swing: 0V DC to $V_{CC} - 1.5V$ DC
- Power Drain Suitable for Battery Operation.

Description

The LM2904, LM358/LM358A, LM258/LM258A consist of two independent, high gain, internally frequency compensated operational amplifiers which were designed specifically to operate from a single power supply over a wide range of voltage. Operation from split power supplies is also possible and the low power supply current drain is independent of the magnitude of the power supply voltage. Application areas include transducer amplifier, DC gain blocks and all the conventional OP-AMP circuits which now can be easily implemented in single power supply systems.

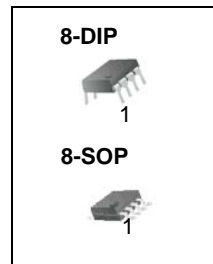

Internal Block Diagram

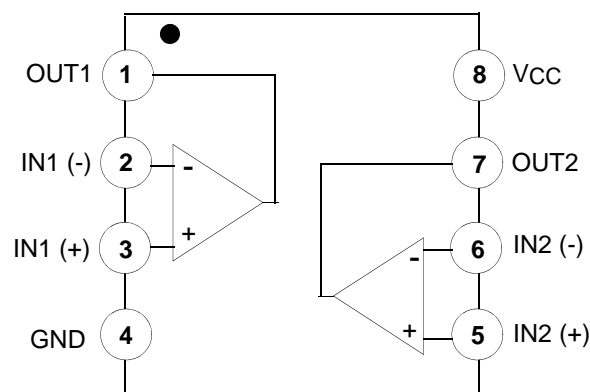

Schematic Diagram

(One section only)

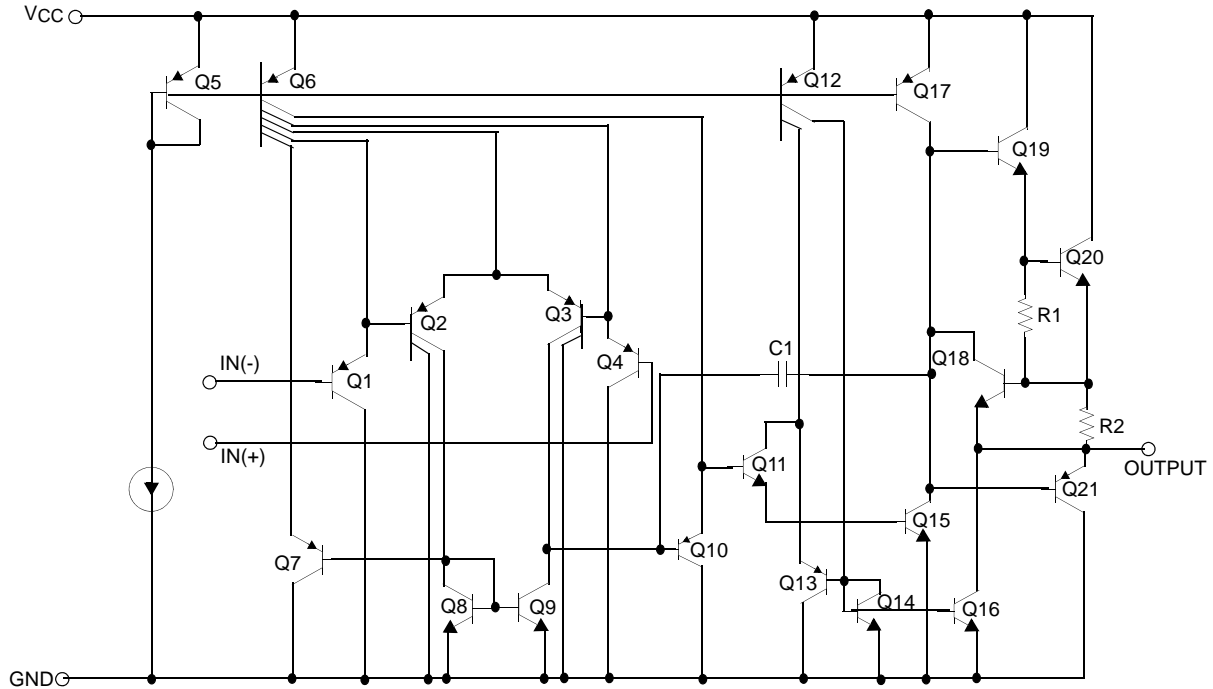

Absolute Maximum Ratings

| Parameter | Symbol | LM258/LM258A | LM358/LM358A | LM2904 | Unit |
|--|----------|--------------|--------------|-------------|------|
| Supply Voltage | VCC | ±16 or 32 | ±16 or 32 | ±13 or 26 | V |
| Differential Input Voltage | VI(DIFF) | 32 | 32 | 26 | V |
| Input Voltage | VI | -0.3 to +32 | -0.3 to +32 | -0.3 to +26 | V |
| Output Short Circuit to GND VCC≤15V, TA = 25°C(One Amp) | - | Continuous | Continuous | Continuous | - |
| Operating Temperature Range | TOPR | -25 ~ +85 | 0 ~ +70 | -40 ~ +85 | °C |
| Maximum Junction Temperature | TJ(MAX) | +150 | +150 | +150 | °C |
| Storage Temperature Range | TSTG | -65 ~ +150 | -65 ~ +150 | -65 ~ +150 | °C |

Electrical Characteristics

(VCC = 5.0V, VEE = GND, TA = 25°C, unless otherwise specified)

| Parameter | Symbol | Conditions | LM258 | | | LM358 | | | LM2904 | | | Unit |
|------------------------------|----------------------|--|-------|------|----------------------|-------|------|----------------------|--------|------|----------------------|------|
| | | | Min. | Typ. | Max. | Min. | Typ. | Max. | Min. | Typ. | Max. | |
| Input Offset Voltage | V _{IO} | V _{CM} = 0V to V _{CC} -1.5V V _{O(P)} = 1.4V, R _S = 0Ω | - | 2.9 | 5.0 | - | 2.9 | 7.0 | - | 2.9 | 7.0 | mV |
| Input Offset Current | I _{IO} | - | - | 3 | 30 | - | 5 | 50 | - | 5 | 50 | nA |
| Input Bias Current | I _{BIAS} | - | - | 45 | 150 | - | 45 | 250 | - | 45 | 250 | nA |
| Input Voltage Range | V _{I(R)} | V _{CC} = 30V (LM2904, V _{CC} =26V) | 0 | - | V _{CC} -1.5 | 0 | - | V _{CC} -1.5 | 0 | - | V _{CC} -1.5 | V |
| Supply Current | I _{CC} | R _L = ∞, V _{CC} = 30V (LM2904, V _{CC} =26V) | - | 0.8 | 2.0 | - | 0.8 | 2.0 | - | 0.8 | 2.0 | mA |
| | | R _L = ∞, V _{CC} = 5V | - | 0.5 | 1.2 | - | 0.5 | 1.2 | - | 0.5 | 1.2 | mA |
| Large Signal Voltage Gain | G _V | V _{CC} = 15V, R _L = 2kΩ V _{O(P)} = 1V to 11V | 50 | 100 | - | 25 | 100 | - | 25 | 100 | - | V/mV |
| Output Voltage Swing | V _{O(H)} | V _{CC} =30V, R _L = 2kΩ | 26 | - | - | 26 | - | - | 22 | - | - | V |
| | | V _{CC} = 26V for LM2904, R _L = 10kΩ | 27 | 28 | - | 27 | 28 | - | 23 | 24 | - | V |
| | V _{O(L)} | V _{CC} = 5V, R _L = 10kΩ | - | 5 | 20 | - | 5 | 20 | - | 5 | 20 | mV |
| Common-Mode Rejection Ratio | CMRR | - | 70 | 85 | - | 65 | 80 | - | 50 | 80 | - | dB |
| Power Supply Rejection Ratio | PSRR | - | 65 | 100 | - | 65 | 100 | - | 50 | 100 | - | dB |
| Channel Separation | CS | f = 1kHz to 20kHz (Note1) | - | 120 | - | - | 120 | - | - | 120 | - | dB |
| Short Circuit to GND | I _{SC} | - | - | 40 | 60 | - | 40 | 60 | - | 40 | 60 | mA |
| Output Current | I _{SOURCE} | V _{I(+)} = 1V, V _{I(-)} = 0V, V _{CC} = 15V, V _{O(P)} = 2V | 20 | 30 | - | 20 | 30 | - | 20 | 30 | - | mA |
| | | V _{I(+)} = 0V, V _{I(-)} = 1V, V _{CC} = 15V, V _{O(P)} = 2V | 10 | 15 | - | 10 | 15 | - | 10 | 15 | - | mA |
| | I _{SINK} | V _{I(+)} = 0V, V _{I(-)} = 1V, V _{CC} = 15V, V _{O(P)} = 200mV | 12 | 100 | - | 12 | 100 | - | - | - | - | μA |
| Differential Input Voltage | V _{I(DIFF)} | - | - | - | V _{CC} | - | - | V _{CC} | - | - | V _{CC} | V |

Note:

1. This parameter, although guaranteed, is not 100% tested in production.

Electrical Characteristics (Continued)

(VCC = 5.0V, VEE = GND, unless otherwise specified)

The following specifications apply over the range of $-25^{\circ}\text{C} \leq T_A \leq +85^{\circ}\text{C}$ for the LM258; and the $0^{\circ}\text{C} \leq T_A \leq +70^{\circ}\text{C}$ for the LM358; and the $-40^{\circ}\text{C} \leq T_A \leq +85^{\circ}\text{C}$ for the LM2904

| Parameter | Symbol | Conditions | LM258 | | | LM358 | | | LM2904 | | | Unit | |
|----------------------------|----------------------|--|-----------------------|------|----------------------|-------|------|----------------------|--------|------|----------------------|-------|---|
| | | | Min. | Typ. | Max. | Min. | Typ. | Max. | Min. | Typ. | Max. | | |
| Input Offset Voltage | V _{IO} | V _{CM} = 0V to V _{CC} -1.5V V _{O(P)} = 1.4V, R _S = 0Ω | - | - | 7.0 | - | - | 9.0 | - | - | 10.0 | mV | |
| Input Offset Voltage Drift | ΔV _{IO} /ΔT | R _S = 0Ω | - | 7.0 | - | - | 7.0 | - | - | 7.0 | - | μV/°C | |
| Input Offset Current | I _{IO} | - | - | - | 100 | - | - | 150 | - | 45 | 200 | nA | |
| Input Offset Current Drift | ΔI _{IO} /ΔT | - | - | 10 | - | - | 10 | - | - | 10 | - | pA/°C | |
| Input Bias Current | I _{BIAS} | - | - | 40 | 300 | - | 40 | 500 | - | 40 | 500 | nA | |
| Input Voltage Range | V _{I(R)} | V _{CC} = 30V (LM2904, V _{CC} = 26V) | 0 | - | V _{CC} -2.0 | 0 | - | V _{CC} -2.0 | 0 | - | V _{CC} -2.0 | V | |
| Large Signal Voltage Gain | G _V | V _{CC} = 15V, R _L = 2.0kΩ V _{O(P)} = 1V to 11V | 25 | - | - | 15 | - | - | 15 | - | - | V/mV | |
| Output Voltage Swing | V _{O(H)} | V _{CC} = 30V (V _{CC} = 26V for LM2904) | R _L = 2kΩ | 26 | - | - | 26 | - | - | 22 | - | - | V |
| | | | R _L = 10kΩ | 27 | 28 | - | 27 | 28 | - | 23 | 24 | - | V |
| | V _{O(L)} | V _{CC} = 5V, R _L = 10kΩ | - | 5 | 20 | - | 5 | 20 | - | 5 | 20 | mV | |
| Output Current | I _{SOURCE} | V _{I(+)} = 1V, V _{I(-)} = 0V, V _{CC} = 15V, V _{O(P)} = 2V | 10 | 30 | - | 10 | 30 | - | 10 | 30 | - | mA | |
| | I _{SINK} | V _{I(+)} = 0V, V _{I(-)} = 1V, V _{CC} = 15V, V _{O(P)} = 2V | 5 | 8 | - | 5 | 9 | - | 5 | 9 | - | mA | |
| Differential Input Voltage | V _{I(DIFF)} | - | - | - | V _{CC} | - | - | V _{CC} | - | - | V _{CC} | V | |

Electrical Characteristics (Continued)

(VCC = 5.0V, VEE = GND, TA = 25°C, unless otherwise specified)

| Parameter | Symbol | Conditions | LM258A | | | LM358A | | | Unit |
|------------------------------|----------------------|---|-----------------------|------|-----------------------|--------|------|-----------------------|------|
| | | | Min. | Typ. | Max. | Min. | Typ. | Max. | |
| Input Offset Voltage | V _{IO} | V _{CM} = 0V to V _{CC} - 1.5V V _{O(P)} = 1.4V, R _S = 0Ω | - | 1.0 | 3.0 | - | 2.0 | 3.0 | mV |
| Input Offset Current | I _{IO} | - | - | 2 | 15 | - | 5 | 30 | nA |
| Input Bias Current | I _{BIAS} | - | - | 40 | 80 | - | 45 | 100 | nA |
| Input Voltage Range | V _{I(R)} | V _{CC} = 30V | 0 | - | V _{CC} - 1.5 | 0 | - | V _{CC} - 1.5 | V |
| Supply Current | I _{CC} | R _L = ∞, V _{CC} = 30V | - | 0.8 | 2.0 | - | 0.8 | 2.0 | mA |
| | | R _L = ∞, V _{CC} = 5V | - | 0.5 | 1.2 | - | 0.5 | 1.2 | mA |
| Large Signal Voltage Gain | G _V | V _{CC} = 15V, R _L = 2kΩ V _O = 1V to 11V | 50 | 100 | - | 25 | 100 | - | V/mV |
| Output Voltage Swing | V _{OH} | V _{CC} = 30V | R _L = 2kΩ | 26 | - | - | 26 | - | V |
| | | | R _L = 10kΩ | 27 | 28 | - | 27 | 28 | - |
| | V _{OL} | V _{CC} = 5V, R _L = 10kΩ | - | 5 | 20 | - | 5 | 20 | mV |
| Common-Mode Rejection Ratio | CMRR | - | 70 | 85 | - | 65 | 85 | - | dB |
| Power Supply Rejection Ratio | PSRR | - | 65 | 100 | - | 65 | 100 | - | dB |
| Channel Separation | CS | f = 1kHz to 20kHz (Note1) | - | 120 | - | - | 120 | - | dB |
| Short Circuit to GND | I _{SC} | - | - | 40 | 60 | - | 40 | 60 | mA |
| Output Current | I _{SOURCE} | V _{I(+)} = 1V, V _{I(-)} = 0V V _{CC} = 15V, V _{O(P)} = 2V | 20 | 30 | - | 20 | 30 | - | mA |
| | I _{SINK} | V _{I(+)} = 1V, V _{I(-)} = 0V V _{CC} = 15V, V _{O(P)} = 2V | 10 | 15 | - | 10 | 15 | - | mA |
| | | V _{in +} = 0V, V _{in (-)} = 1V V _{O(P)} = 200mV | 12 | 100 | - | 12 | 100 | - | μA |
| Differential Input Voltage | V _{I(DIFF)} | - | - | - | V _{CC} | - | - | V _{CC} | V |

Note:

1. This parameter, although guaranteed, is not 100% tested in production.

Electrical Characteristics (Continued)

(VCC = 5.0V, VEE = GND, unless otherwise specified)

The following specifications apply over the range of $-25^{\circ}\text{C} \leq T_A \leq +85^{\circ}\text{C}$ for the LM258A; and the $0^{\circ}\text{C} \leq T_A \leq +70^{\circ}\text{C}$ for the LM358A

| Parameter | Symbol | Conditions | LM258A | | | LM358A | | | Unit | |
|---------------------------------|--------------------------|---|-------------------|------|----------------|--------|------|----------------|--------------------------------|---|
| | | | Min. | Typ. | Max. | Min. | Typ. | Max. | | |
| Input Offset Voltage | V_{IO} | $V_{CM} = 0V$ to $V_{CC} - 1.5V$ $V_{O(P)} = 1.4V$, $R_S = 0\Omega$ | - | - | 4.0 | - | - | 5.0 | mV | |
| Input Offset Voltage Drift | $\Delta V_{IO}/\Delta T$ | - | - | 7.0 | 15 | - | 7.0 | 20 | $\mu\text{V}/^{\circ}\text{C}$ | |
| Input Offset Current | I_{IO} | - | - | - | 30 | - | - | 75 | nA | |
| Input Offset Current Drift | $\Delta I_{IO}/\Delta T$ | - | - | 10 | 200 | - | 10 | 300 | $\text{pA}/^{\circ}\text{C}$ | |
| Input Bias Current | I_{BIAS} | - | - | 40 | 100 | - | 40 | 200 | nA | |
| Input Common-Mode Voltage Range | $V_{I(R)}$ | $V_{CC} = 30V$ | 0 | - | $V_{CC} - 2.0$ | 0 | - | $V_{CC} - 2.0$ | V | |
| Output Voltage Swing | $V_{O(H)}$ | $V_{CC} = 30V$ | $R_L = 2k\Omega$ | 26 | - | - | 26 | - | - | V |
| | | | $R_L = 10k\Omega$ | 27 | 28 | - | 27 | 28 | - | V |
| | $V_{O(L)}$ | $V_{CC} = 5V$, $R_L = 10k\Omega$ | - | 5 | 20 | - | 5 | 20 | mV | |
| Large Signal Voltage Gain | G_V | $V_{CC} = 15V$, $R_L = 2.0k\Omega$ $V_{O(P)} = 1V$ to $11V$ | 25 | - | - | 15 | - | - | V/mV | |
| Output Current | I_{SOURCE} | $V_{I(+)} = 1V$, $V_{I(-)} = 0V$ $V_{CC} = 15V$, $V_{O(P)} = 2V$ | 10 | 30 | - | 10 | 30 | - | mA | |
| | I_{SINK} | $V_{I(+)} = 1V$, $V_{I(-)} = 0V$ $V_{CC} = 15V$, $V_{O(P)} = 2V$ | 5 | 9 | - | 5 | 9 | - | mA | |
| Differential Input Voltage | $V_{I(DIFF)}$ | - | - | - | V_{CC} | - | - | V_{CC} | V | |

Typical Performance Characteristics

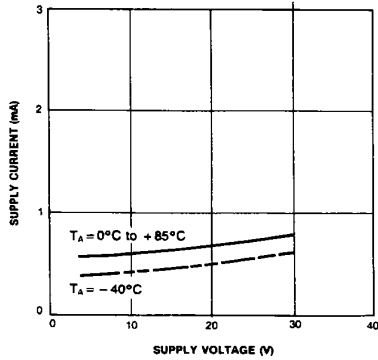

Figure 1. Supply Current vs Supply Voltage

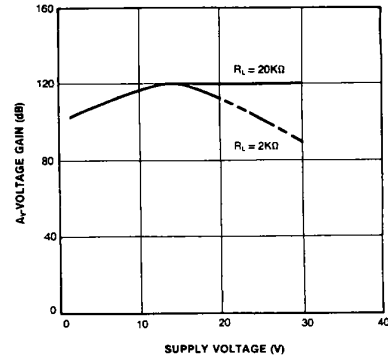

Figure 2. Voltage Gain vs Supply Voltage

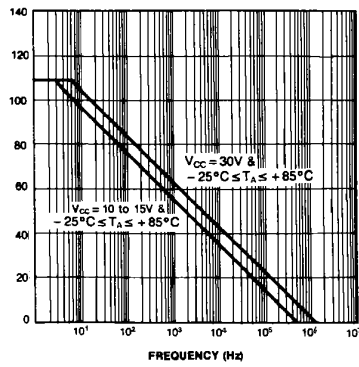

Figure 3. Open Loop Frequency Response

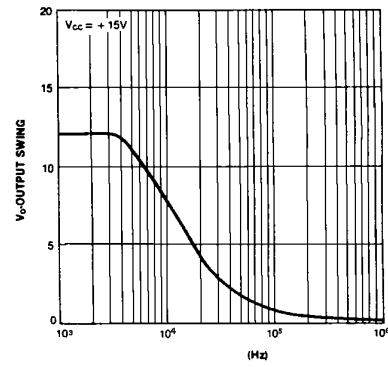

Figure 4. Large Signal Output Swing vs Frequency

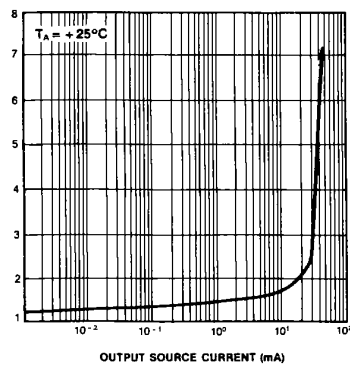

Figure 5. Output Characteristics vs Current Sourcing

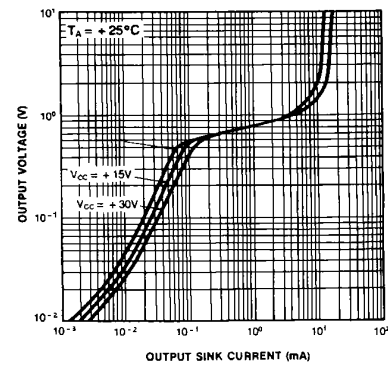

Figure 6. Output Characteristics vs Current Sinking

Typical Performance Characteristics (Continued)

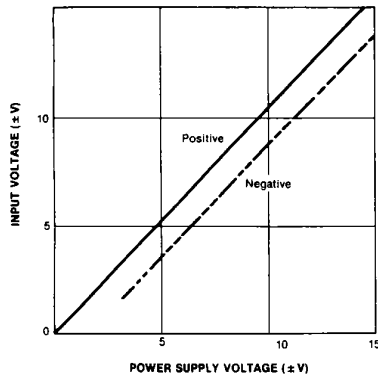

Figure 7. Input Voltage Range vs Supply Voltage

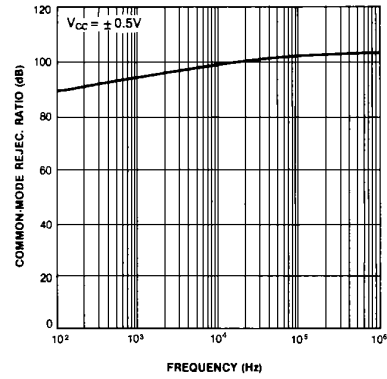

Figure 8. Common-Mode Rejection Ratio

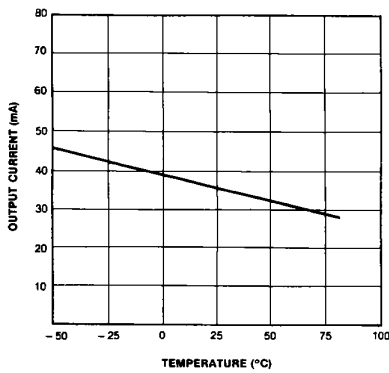

Figure 9. Output Current vs Temperature (Current Limiting)

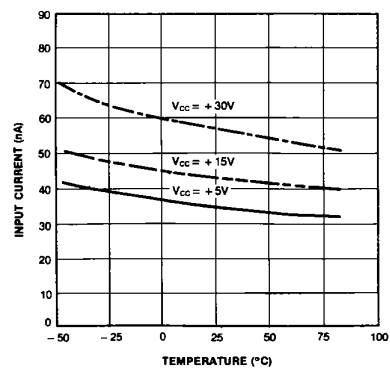

Figure 10. Input Current vs Temperature

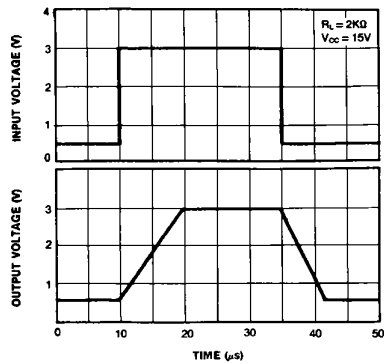

Figure 11. Voltage Follower Pulse Response

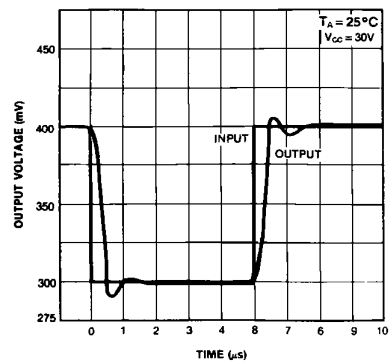

Figure 12. Voltage Follower Pulse Response (Small Signal)

Mechanical Dimensions

Package

Dimensions in millimeters

8-DIP

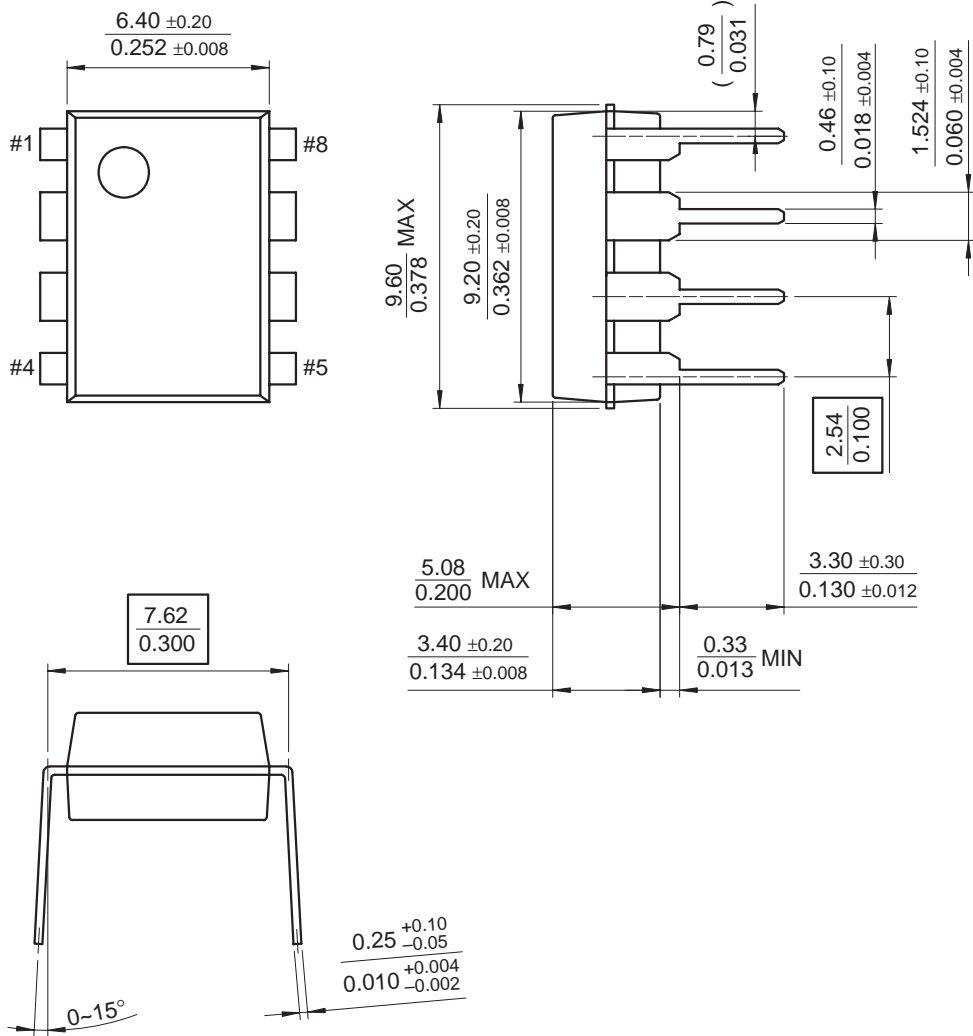

Mechanical Dimensions (Continued)

Package

Dimensions in millimeters

8-SOP

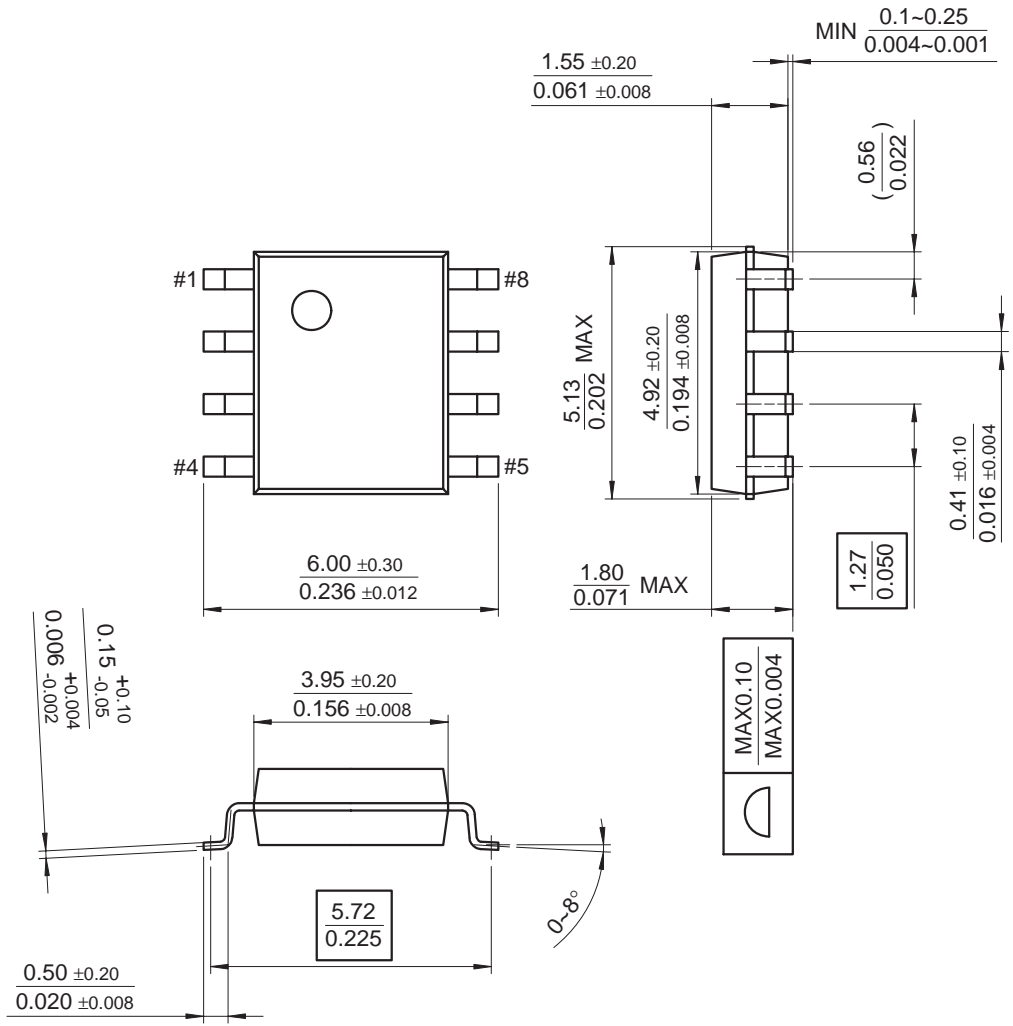

Ordering Information

| Product Number | Package | Operating Temperature |
|----------------|---------|-----------------------|
| LM358N | 8-DIP | 0 ~ +70°C |
| LM358AN | | |
| LM358M | 8-SOP | |
| LM358AM | | |
| LM2904N | 8-DIP | -40 ~ +85°C |
| LM2904M | 8-SOP | |
| LM258N | 8-DIP | -25 ~ +85°C |
| LM258AN | | |
| LM258M | 8-SOP | |
| LM258AM | | |

DISCLAIMER

FAIRCHILD SEMICONDUCTOR RESERVES THE RIGHT TO MAKE CHANGES WITHOUT FURTHER NOTICE TO ANY PRODUCTS HEREIN TO IMPROVE RELIABILITY, FUNCTION OR DESIGN. FAIRCHILD DOES NOT ASSUME ANY LIABILITY ARISING OUT OF THE APPLICATION OR USE OF ANY PRODUCT OR CIRCUIT DESCRIBED HEREIN; NEITHER DOES IT CONVEY ANY LICENSE UNDER ITS PATENT RIGHTS, NOR THE RIGHTS OF OTHERS.

LIFE SUPPORT POLICY

FAIRCHILD'S PRODUCTS ARE NOT AUTHORIZED FOR USE AS CRITICAL COMPONENTS IN LIFE SUPPORT DEVICES OR SYSTEMS WITHOUT THE EXPRESS WRITTEN APPROVAL OF THE PRESIDENT OF FAIRCHILD SEMICONDUCTOR CORPORATION. As used herein:

1. Life support devices or systems are devices or systems which, (a) are intended for surgical implant into the body, or (b) support or sustain life, and (c) whose failure to perform when properly used in accordance with instructions for use provided in the labeling, can be reasonably expected to result in a significant injury of the user.
2. A critical component in any component of a life support device or system whose failure to perform can be reasonably expected to cause the failure of the life support device or system, or to affect its safety or effectiveness.