

# Photomicrosensor (Transmissive) EE-SX1107

## ■ Dimensions

Note: All units are in millimeters unless otherwise indicated.

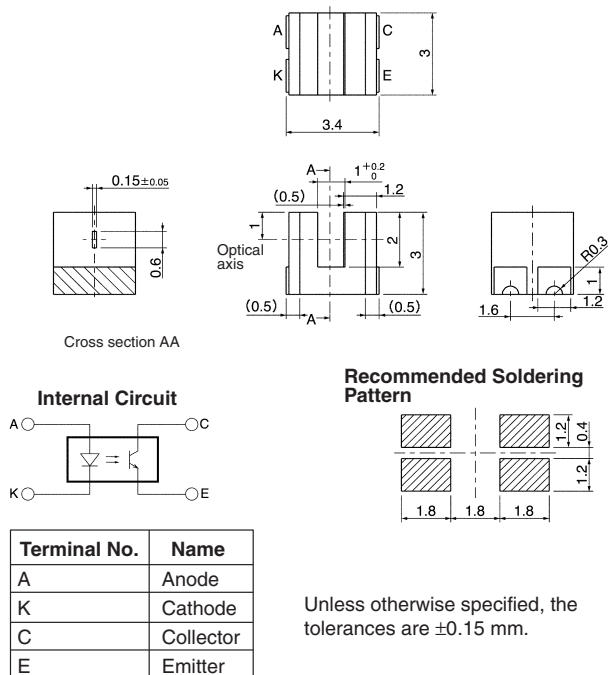

## ■ Features

- Ultra-compact with a 3.4-mm-wide sensor and a 1-mm-wide slot.
- PCB surface mounting type.
- High resolution with a 0.15-mm-wide aperture.
- RoHS Compliant.

## ■ Absolute Maximum Ratings (Ta = 25°C)

Item	Symbol	Rated value
Emitter	Forward current	$I_F$ 25 mA (see note 1)
	Pulse forward current	$I_{FP}$ 100 mA (see note 2)
	Reverse voltage	$V_R$ 5 V
Detector	Collector–Emitter voltage	$V_{CEO}$ 20 V
	Emitter–Collector voltage	$V_{ECO}$ 5 V
	Collector current	$I_C$ 20 mA
	Collector dissipation	$P_C$ 75 mW (see note 1)
Ambient temperature	Operating	$T_{opr}$ -30°C to 85°C
	Storage	$T_{stg}$ -40°C to 90°C
	Reflow soldering	$T_{sol}$ 255°C (see note 3)
	Manual soldering	$T_{sol}$ 350°C (see note 3)

- Note:**
1. Refer to the temperature rating chart if the ambient temperature exceeds 25°C.
  2. Duty: 1/100; Pulse width: 0.1 ms
  3. Complete soldering within 10 seconds for reflow soldering and within 3 seconds for manual soldering.

## ■ Ordering Information

Description	Model
Photomicrosensor (transmissive)	EE-SX1107

## ■ Electrical and Optical Characteristics (Ta = 25°C)

Item	Symbol	Value	Condition
Emitter	Forward voltage	$V_F$ 1.1 V typ., 1.3 V max.	$I_F = 5$ mA
	Reverse current	$I_R$ 10 $\mu$ A max.	$V_R = 5$ V
	Peak emission wavelength	$\lambda_p$ 940 nm typ.	$I_F = 20$ mA
Detector	Light current	$I_L$ 50 $\mu$ A min., 150 $\mu$ A typ., 500 $\mu$ A max.	$I_F = 5$ mA, $V_{CE} = 5$ V
	Dark current	$I_D$ 100 nA max.	$V_{CE} = 10$ V, 0 lx
	Leakage current	$I_{LEAK}$ ---	---
	Collector–Emitter saturated voltage	$V_{CE(sat)}$ 0.1 V typ., 0.4 V max.	$I_F = 20$ mA, $I_L = 50$ $\mu$ A
	Peak spectral sensitivity wavelength	$\lambda_p$ 900 nm typ.	---
Rising time	$t_r$ 10 $\mu$ s typ.	$V_{CC} = 5$ V, $R_L = 1$ k $\Omega$ , $I_L = 100$ $\mu$ A	
Falling time	$t_f$ 10 $\mu$ s typ.	$V_{CC} = 5$ V, $R_L = 1$ k $\Omega$ , $I_L = 100$ $\mu$ A	

■ Engineering Data

**Forward Current vs. Collector Dissipation Temperature Rating**

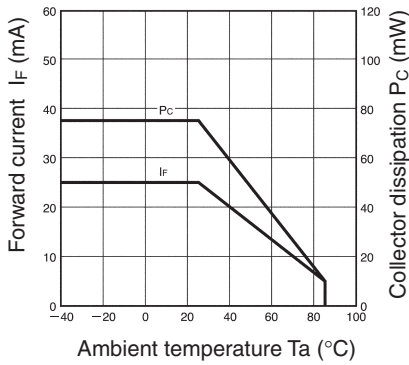

**Forward Current vs. Forward Voltage Characteristics (Typical)**

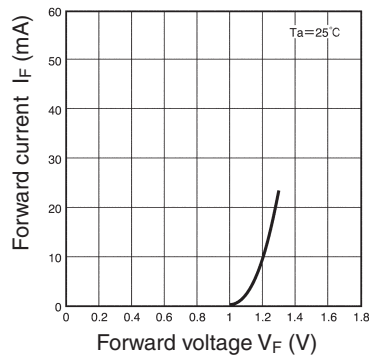

**Light Current vs. Forward Current Characteristics (Typical)**

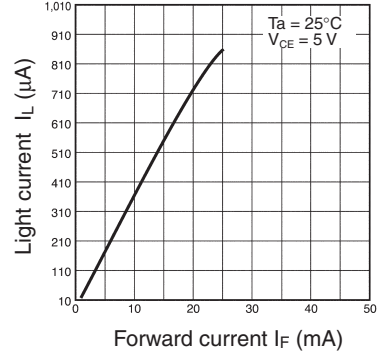

**Light Current vs. Collector–Emitter Voltage Characteristics (Typical)**

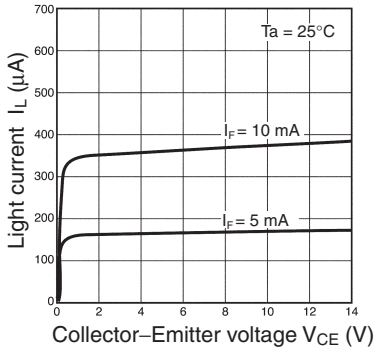

**Relative Light Current vs. Ambient Temperature Characteristics (Typical)**

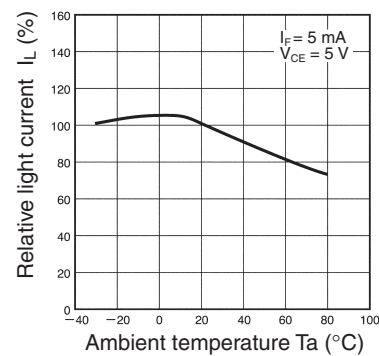

**Dark Current vs. Ambient Temperature Characteristics (Typical)**

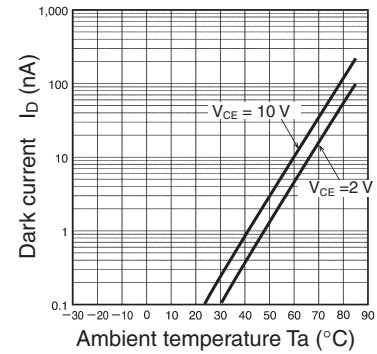

**Response Time vs. Load Resistance Characteristics (Typical)**

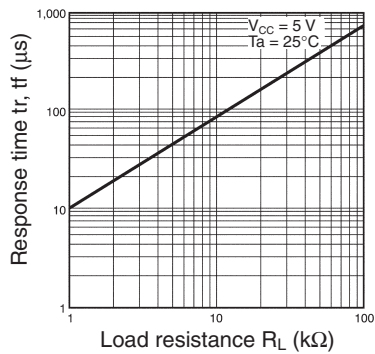

**Sensing Position Characteristics (Typical)**

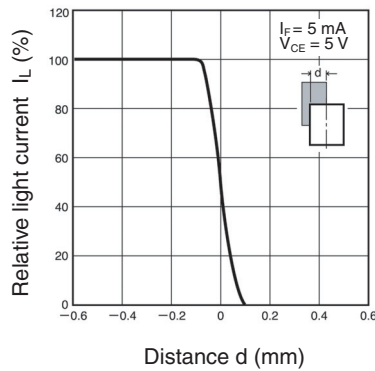

**Sensing Position Characteristics (Typical)**

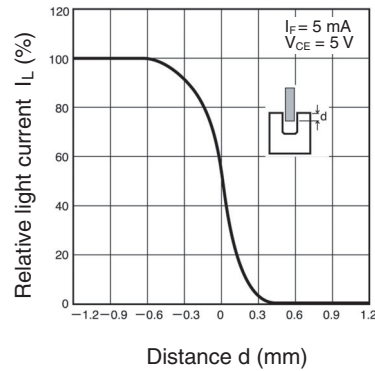

**Response Time Measurement Circuit**

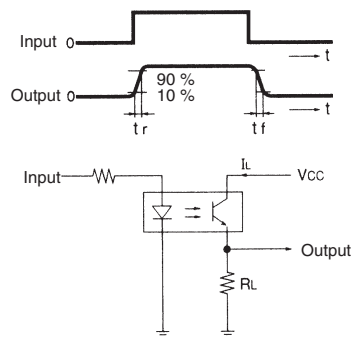

Unit: mm (inch)

■ Tape and Reel

Reel

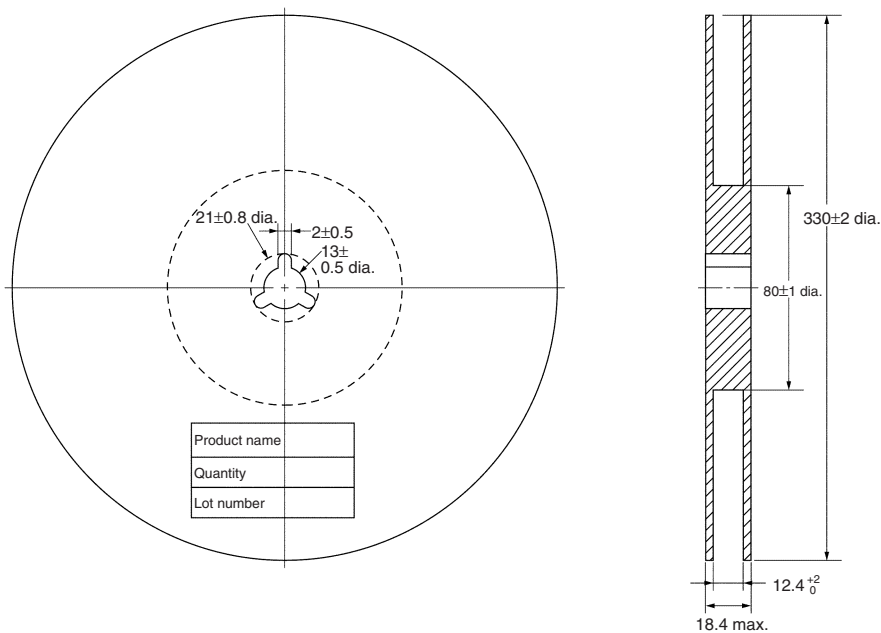

Tape

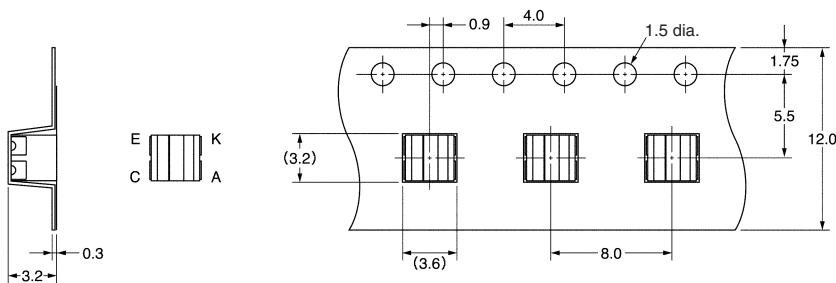

Tape configuration

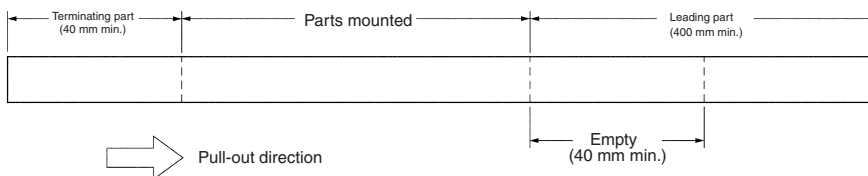

Tape quantity

2,500 pcs./reel

# Precautions

## ■ Soldering Information

### Reflow soldering

- The following soldering paste is recommended:  
Melting temperature: 216 to 220°C  
Composition: Sn 3.5 Ag 0.75 Cu
- The recommended thickness of the metal mask for screen printing is between 0.2 and 0.25 mm.
- Set the reflow oven so that the temperature profile shown in the following chart is obtained for the upper surface of the product being soldered.

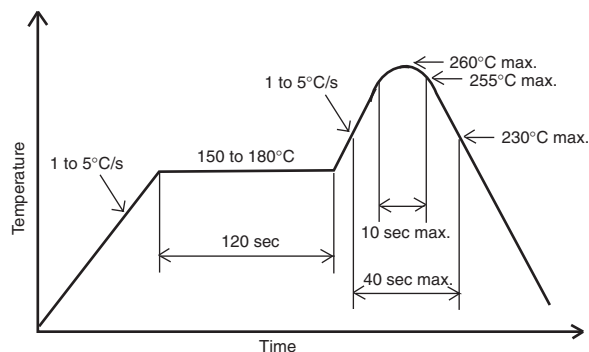

### Manual soldering

- Use "Sn 60" (60% tin and 40% lead) or solder with silver content.
- Use a soldering iron of less than 25 W, and keep the temperature of the iron tip at 350°C or below.
- Solder each point for a maximum of three seconds.
- After soldering, allow the product to return to room temperature before handling it.

### Storage

To protect the product from the effects of humidity until the package is opened, dry-box storage is recommended. If this is not possible, store the product under the following conditions:

Temperature: 10 to 30°C

Humidity: 60% max.

The product is packed in a humidity-proof envelope. Reflow soldering must be done within 48 hours after opening the envelope, during which time the product must be stored under 30°C at 80% maximum humidity.

If it is necessary to store the product after opening the envelope, use dry-box storage or reseal the envelope.

### Baking

If a product has remained packed in a humidity-proof envelope for six months or more, or if more than 48 hours have lapsed since the envelope was opened, bake the product under the following conditions before use:

Reel: 60°C for 24 hours or more

Bulk: 80°C for 4 hours or more



All sales are subject to Omron Electronic Components LLC standard terms and conditions of sale, which can be found at [http://www.components.omron.com/components/web/webfiles.nsf/sales\\_terms.html](http://www.components.omron.com/components/web/webfiles.nsf/sales_terms.html)

**ALL DIMENSIONS SHOWN ARE IN MILLIMETERS.**  
To convert millimeters into inches, multiply by 0.03937. To convert grams into ounces, multiply by 0.03527.

---

**OMRON**<sup>®</sup>

**OMRON ELECTRONIC  
COMPONENTS LLC**

55 E. Commerce Drive, Suite B  
Schaumburg, IL 60173

**847-882-2288**

**OMRON ON-LINE**

Global - <http://www.omron.com>

USA - <http://www.components.omron.com>

Cat. No. X305-E-1

10/10

Specifications subject to change without notice

Printed in USA

---

Photomicrosensor (Transmissive) **EE-SX1107**