

Photomicrosensor (Transmissive) EE-SX3009-P1/-SX4009-P1

■ Dimensions

Note: All units are in millimeters unless otherwise indicated.

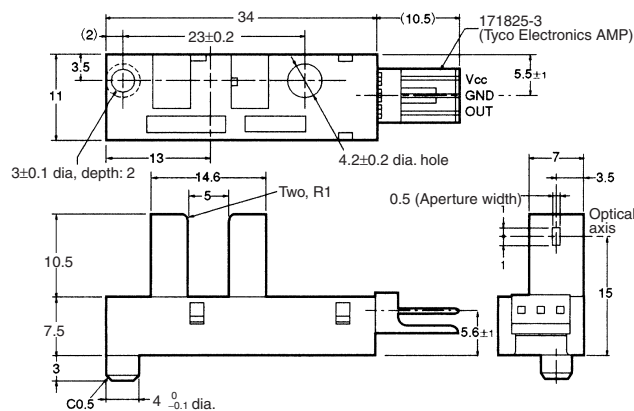

Internal Circuit

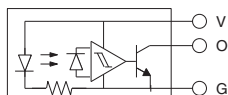

Unless otherwise specified, the tolerances are as shown below.

Terminal No.	Name	Dimensions	Tolerance
V	Power supply (V _{CC})	4 mm max.	±0.2
O	Output (OUT)	4 < mm ≤ 16	±0.3
G	Ground (GND)	16 < mm ≤ 63	±0.5

Recommended Mating Connectors:
 Tyco Electronics AMP 171822-3 (crimp connector)
 172142-3 (crimp connector)
 OMRON EE-1005 (with harness)

■ Features

- Screw-mounting model.
- High resolution with a 0.5-mm-wide sensing aperture.
- With a 5-mm-wide groove.
- Photo IC output signals directly connect with C-MOS and TTL.
- Connects to Tyco Electronics AMP's EI-series connectors.
- RoHS Compliant.

■ Absolute Maximum Ratings (Ta = 25°C)

Item	Symbol	Rated value	
Power supply voltage	V _{CC}	10 V	
Output voltage	V _{OUT}	28 V	
Output current	I _{OUT}	16 mA	
Permissible output dissipation	P _{OUT}	250 mW (see note)	
Ambient temperature	Operating	T _{opr}	-25°C to 75°C
	Storage	T _{stg}	-40°C to 85°C
Soldering temperature	T _{sol}	---	

Note: Refer to the temperature rating chart if the ambient temperature exceeds 25°C.

■ Ordering Information

Description	Model	
Photomicrosensor (transmissive)	Dark ON	EE-SX3009-P1
	Light ON	EE-SX4009-P1

■ Electrical and Optical Characteristics (Ta = 25°C, V_{CC} = 5 V ±10%)

Item	Symbol	Value	Condition
Current consumption	I _{CC}	30 mA max.	With and without incident
Low-level output voltage	V _{OL}	0.3 V max.	I _{OUT} = 16 mA Without incident (EE-SX3009-P1) With incident (EE-SX4009-P1)
High-level output voltage	V _{OH}	(V _{CC} × 0.9) V min.	V _{OUT} = V _{CC} With incident (EE-SX3009-P1) Without incident (EE-SX4009-P1), R _L = 47 kΩ
Response frequency	f	3 kHz min.	V _{OUT} = V _{CC} , R _L = 47 kΩ (see note)

Note: The value of the response frequency is measured by rotating the disk as shown below.

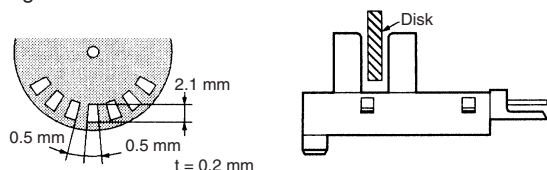

■ Engineering Data

Note: The values in the parentheses apply to the EE-SX4009-P1.

Output Allowable Dissipation vs. Ambient Temperature Characteristics

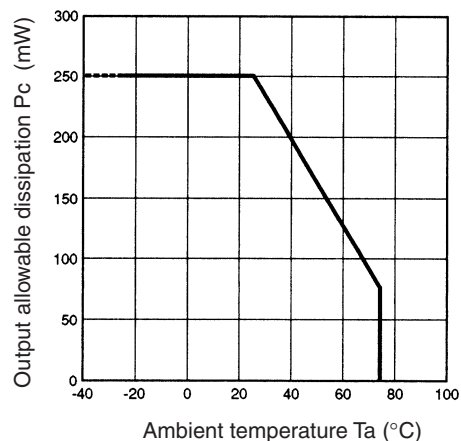

Sensing Position Characteristics (Typical)

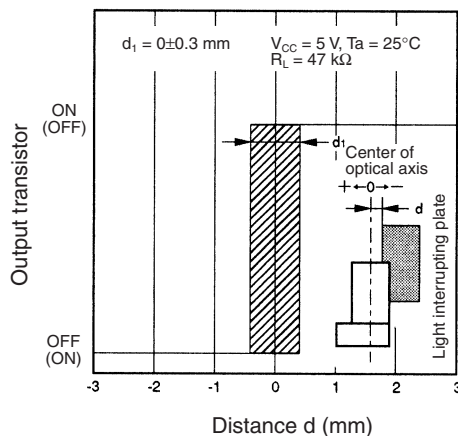

EE-1005 Connector

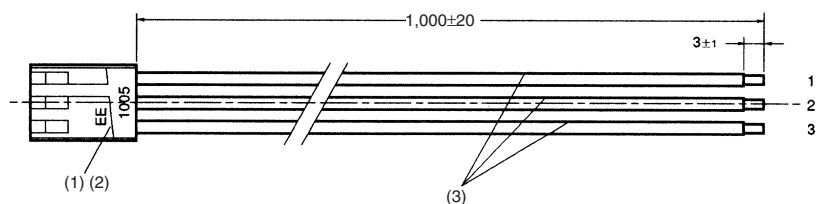

Wiring

No.	Name	Model	Quantity	Maker
1	Receptacle housing	171822-3	1	Tyco Electronics AMP
2	Receptacle contact	170262-1	3	Tyco Electronics AMP
3	Lead wire	UL1007 AWG24	3	---

Connector circuit no.	Lead wire color	Output when connected to EE-SX4009-P1/EE-SX3009-P1
1	Red	V _{CC}
2	Orange	GND
3	Yellow	OUT

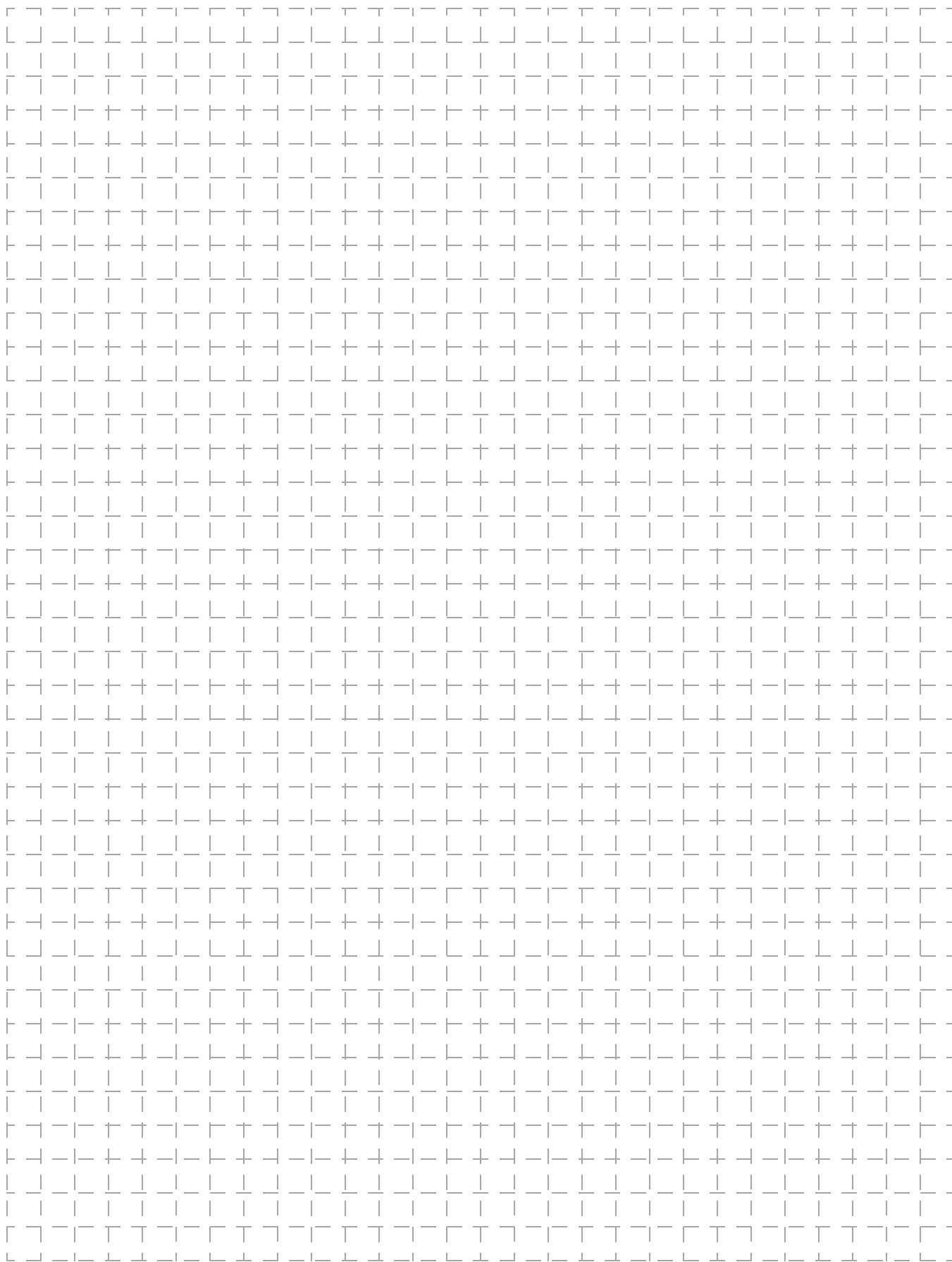

All sales are subject to Omron Electronic Components LLC standard terms and conditions of sale, which can be found at http://www.components.omron.com/components/web/webfiles.nsf/sales_terms.html

ALL DIMENSIONS SHOWN ARE IN MILLIMETERS.
To convert millimeters into inches, multiply by 0.03937. To convert grams into ounces, multiply by 0.03527.

OMRON[®]

**OMRON ELECTRONIC
COMPONENTS LLC**

55 E. Commerce Drive, Suite B
Schaumburg, IL 60173

847-882-2288

OMRON ON-LINE

Global - <http://www.omron.com>

USA - <http://www.components.omron.com>

Cat. No. X305-E-1

10/10

Specifications subject to change without notice

Printed in USA

Photomicrosensor (Transmissive) **EE-SX3009-P1/-SX4009-P1**