

## Optocoupler, Phototransistor Output, AC Input, with Base Connection

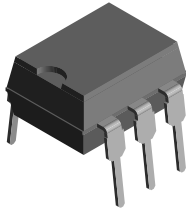

i179010

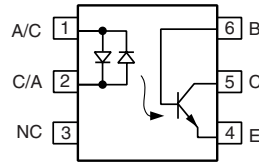

### DESCRIPTION

The H11AA1 is a bi-directional input optically coupled isolator consisting of two inverse parallel gallium arsenide infrared LEDs coupled to a silicon NPN phototransistor in a 6 pin DIP package. The H11AA1 has a minimum CTR of 20 %, a CTR symmetry of 1:3 and is designed for applications requiring detection or monitoring of AC signals.

### FEATURES

- AC or polarity insensitive input
- Built-in reverse polarity input protection
- I/O compatible with integrated circuits
- Industry standard DIP package
- Isolation test voltage: 5300 V<sub>RMS</sub>
- Lead (Pb)-free component
- Component in accordance to RoHS 2002/95/EC and WEEE 2002/96/EC

**RoHS**  
COMPLIANT

### APPLICATIONS

- Telephone line detection
- AC line motor
- PLC
- Instrumentation

### AGENCY APPROVALS

- UL1577, file no. E52744 system code H or J, double protection
- CSA 93751
- BSI IEC 60950; IEC 60065
- DIN EN 60747-5-5 available with option 1
- FIMKO

### ORDER INFORMATION

PART	REMARKS
H11AA1	CTR > 20 %, DIP-6
H11AA1-X006	CTR > 20 %, DIP-6 400 mil (option 6)
H11AA1-X007	CTR > 20 %, SMD-6 (option 7)
H11AA1-X009	CTR > 20 %, SMD-6 (option 9)

#### Note

For additional information on the available options refer to option information.

### ABSOLUTE MAXIMUM RATINGS

PARAMETER	TEST CONDITION	SYMBOL	VALUE	UNIT
<b>INPUT</b>				
Forward continuous current		I <sub>F</sub>	60	mA
Power dissipation		P <sub>diss</sub>	100	mW
Derate linearly from 25 °C			1.3	mW/°C
<b>OUTPUT</b>				
Power dissipation		P <sub>diss</sub>	200	mW
Derate linearly from 25 °C			2.6	mW/°C
Collector emitter breakdown voltage		BV <sub>CEO</sub>	30	V
Emitter base breakdown voltage		BV <sub>EBO</sub>	5	V
Collector base breakdown voltage		BV <sub>CBO</sub>	70	V

ABSOLUTE MAXIMUM RATINGS				
PARAMETER	TEST CONDITION	SYMBOL	VALUE	UNIT
<b>COUPLER</b>				
Isolation test voltage (RMS)	between emitter and detector, referred to standard climate 23 °C/50% RH, DIN 50014	$V_{ISO}$	5300	$V_{RMS}$
Creepage distance			$\geq 7$	mm
Clearance distance			$\geq 7$	mm
Comparative tracking index	per DIN IEC 112/VDE 0303, part 1	CTI	175	
Isolation resistance	$V_{IO} = 500\text{ V}$ , $T_{amb} = 25\text{ °C}$	$R_{IO}$	$\geq 10^{12}$	$\Omega$
	$V_{IO} = 500\text{ V}$ , $T_{amb} = 100\text{ °C}$	$R_{IO}$	$\geq 10^{11}$	$\Omega$
Storage temperature range		$T_{stg}$	- 55 to + 150	°C
Operating temperature range		$T_{amb}$	- 55 to + 100	°C
Lead soldering time at 260 °C		$T_{sld}$	10	s

**Note**

$T_{amb} = 25\text{ °C}$ , unless otherwise specified.

Stresses in excess of the absolute maximum ratings can cause permanent damage to the device. Functional operation of the device is not implied at these or any other conditions in excess of those given in the operational sections of this document. Exposure to absolute maximum ratings for extended periods of the time can adversely affect reliability.

ELECTRICAL CHARACTERISTICS						
PARAMETER	TEST CONDITION	SYMBOL	MIN.	TYP.	MAX.	UNIT
<b>INPUT</b>						
Forward voltage	$I_F = 10\text{ mA}$	$V_F$		1.2	1.5	V
<b>OUTPUT</b>						
Collector emitter breakdown voltage	$I_C = 1\text{ mA}$	$BV_{CEO}$	30			V
Emitter base breakdown voltage	$I_E = 100\text{ }\mu\text{A}$	$BV_{EBO}$	5			V
Collector base breakdown voltage	$I_C = 100\text{ }\mu\text{A}$	$BV_{CBO}$	70			V
Collector emitter leakage current	$V_{CE} = 10\text{ V}$	$I_{CEO}$		5	100	nA
<b>COUPLER</b>						
Collector emitter saturation voltage	$I_F = 10\text{ mA}$ , $I_C = 0.5\text{ mA}$	$V_{CEsat}$			0.4	V

**Note**

$T_{amb} = 25\text{ °C}$ , unless otherwise specified.

Minimum and maximum values were tested requirements. Typical values are characteristics of the device and are the result of engineering evaluations. Typical values are for information only and are not part of the testing requirements.

CURRENT TRANSFER RATIO						
PARAMETER	TEST CONDITION	SYMBOL	MIN.	TYP.	MAX.	UNIT
DC current transfer ratio	$I_F = 10\text{ mA}$ , $V_{CE} = 10\text{ V}$	$CTR_{DC}$	20			%
Symmetry (CTR at + 10 mA)/(CTR at - 10 mA)			0.33	1	3	

## TYPICAL CHARACTERISTICS

$T_{amb} = 25\text{ }^{\circ}\text{C}$ , unless otherwise specified

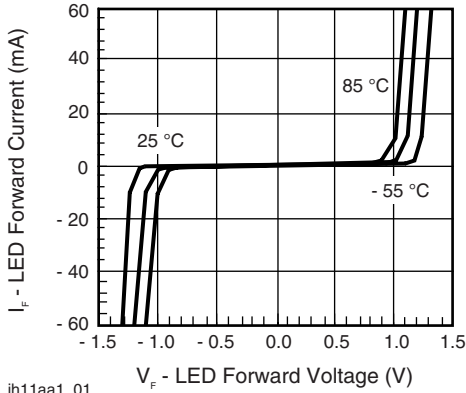

ih11aa1\_01

Fig. 1 - LED Forward Current vs. Forward Voltage

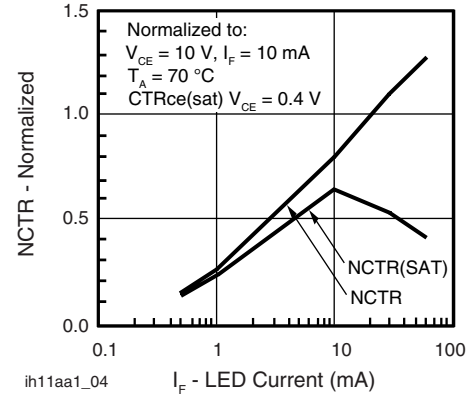

ih11aa1\_04

Fig. 4 - Normalized Non-Saturated and Saturated CTR vs. LED Current

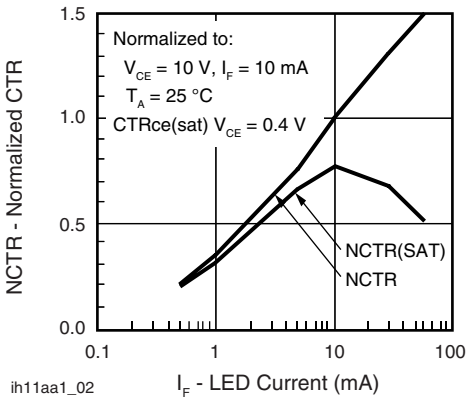

ih11aa1\_02

Fig. 2 - Normalized Non-Saturated and Saturated CTR vs. LED Current

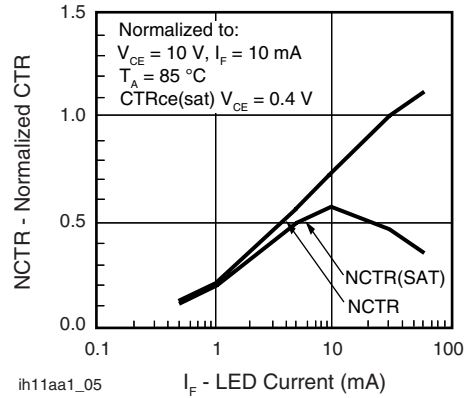

ih11aa1\_05

Fig. 5 - Normalized Non-Saturated and Saturated CTR vs. LED Current

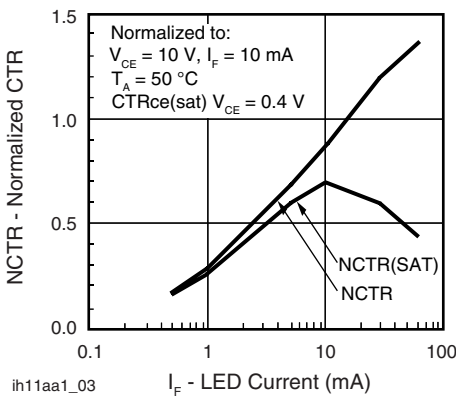

ih11aa1\_03

Fig. 3 - Normalized Non-Saturated and Saturated CTR vs. LED Current

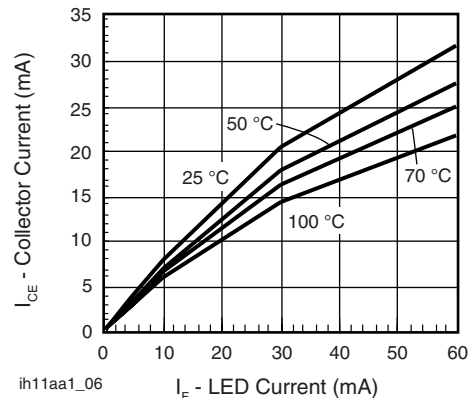

ih11aa1\_06

Fig. 6 - Collector Emitter Current vs. Temperature and LED Current

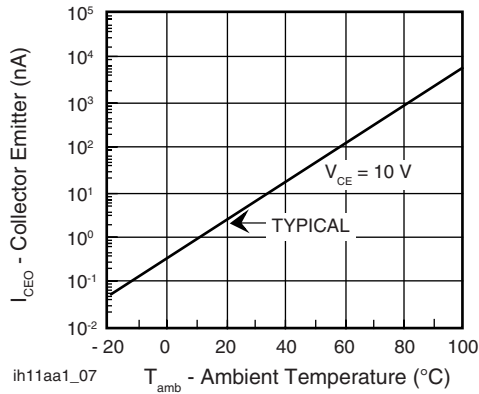

Fig. 7 - Collector Emitter Leakage Current vs. Temperature

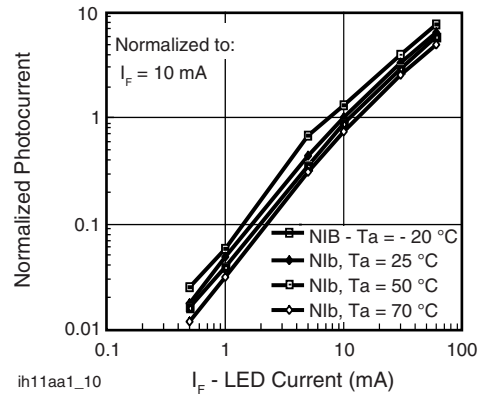

Fig. 10 - Normalized Photocurrent vs. LED Current

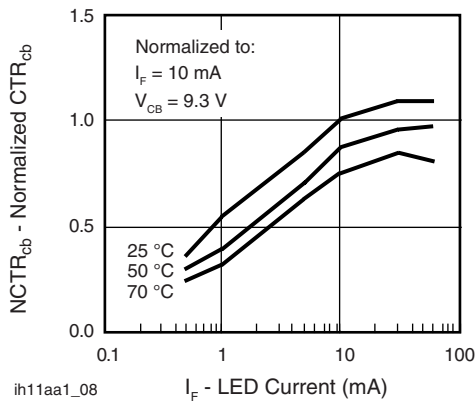

Fig. 8 - Normalized  $CTR_{cb}$  vs. LED Current and Temperature

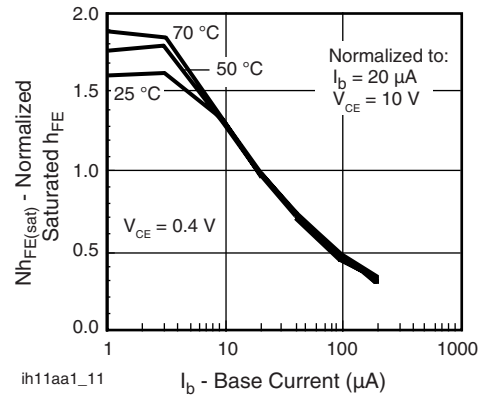

Fig. 11 - Normalized Saturated  $h_{FE}$  vs. Base Current and Temperature

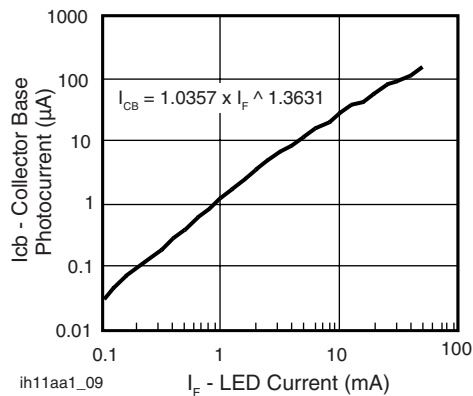

Fig. 9 - Collector Base Photocurrent vs. LED Current

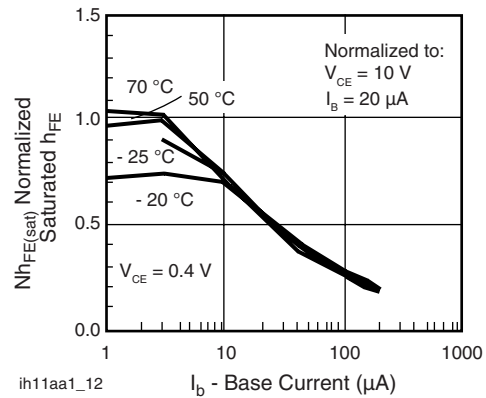

Fig. 12 - Normalized Saturated  $h_{FE}$  vs. Base Current and Temperature

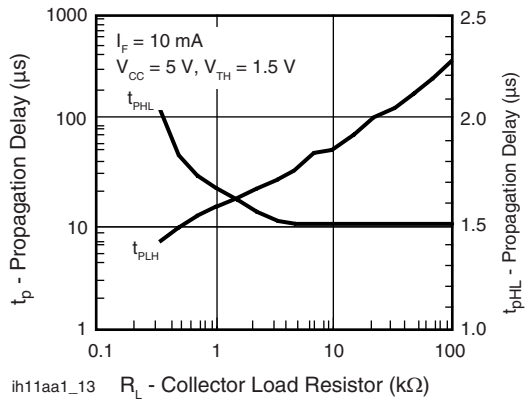
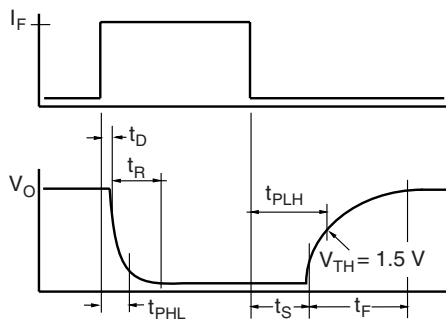
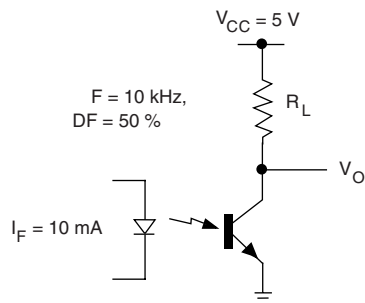

Fig. 13 - Propagation Delay vs. Collector Load Resistor



ih11aa1\_14

Fig. 14 - Switching Waveform



ih11aa1\_15

Fig. 15 - Switching Schematic

# H11AA1



Vishay Semiconductors Optocoupler, Phototransistor Output,  
AC Input, with Base Connection

## PACKAGE DIMENSIONS in inches (millimeters)

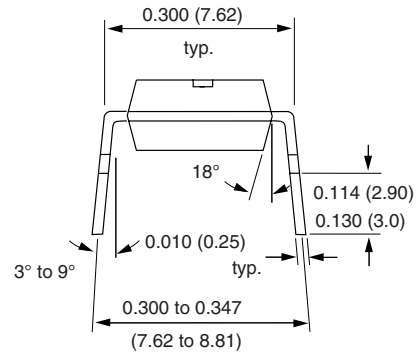
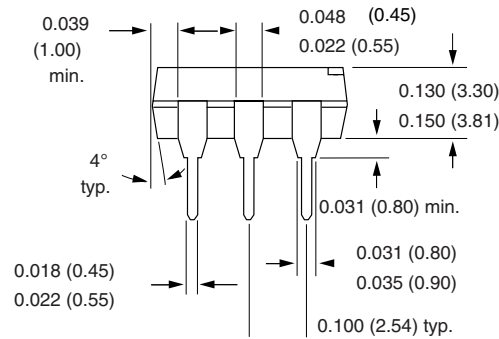
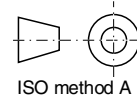
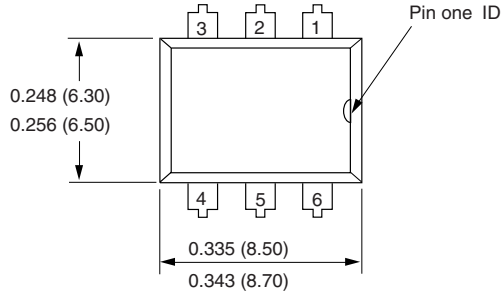

i178004

### Option 6

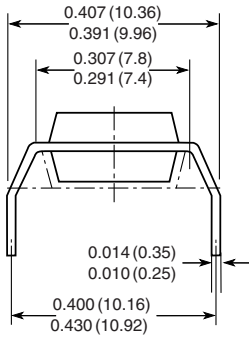

### Option 7

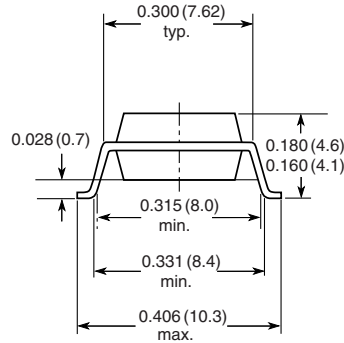

### Option 9

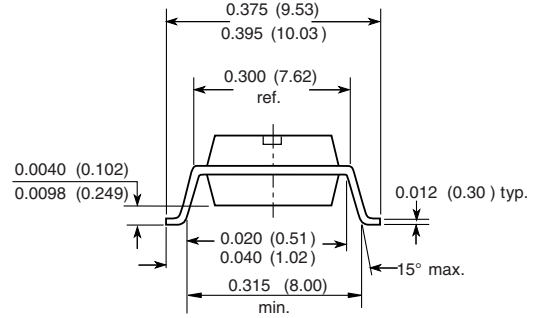

18450

**OZONE DEPLETING SUBSTANCES POLICY STATEMENT**

It is the policy of Vishay Semiconductor GmbH to

1. Meet all present and future national and international statutory requirements.
2. Regularly and continuously improve the performance of our products, processes, distribution and operating systems with respect to their impact on the health and safety of our employees and the public, as well as their impact on the environment.

It is particular concern to control or eliminate releases of those substances into the atmosphere which are known as ozone depleting substances (ODSs).

The Montreal Protocol (1987) and its London Amendments (1990) intend to severely restrict the use of ODSs and forbid their use within the next ten years. Various national and international initiatives are pressing for an earlier ban on these substances.

Vishay Semiconductor GmbH has been able to use its policy of continuous improvements to eliminate the use of ODSs listed in the following documents.

1. Annex A, B and list of transitional substances of the Montreal Protocol and the London Amendments respectively.
2. Class I and II ozone depleting substances in the Clean Air Act Amendments of 1990 by the Environmental Protection Agency (EPA) in the USA
3. Council Decision 88/540/EEC and 91/690/EEC Annex A, B and C (transitional substances) respectively.

Vishay Semiconductor GmbH can certify that our semiconductors are not manufactured with ozone depleting substances and do not contain such substances.

We reserve the right to make changes to improve technical design  
and may do so without further notice.

Parameters can vary in different applications. All operating parameters must be validated for each customer application by the customer. Should the buyer use Vishay Semiconductors products for any unintended or unauthorized application, the buyer shall indemnify Vishay Semiconductors against all claims, costs, damages, and expenses, arising out of, directly or indirectly, any claim of personal damage, injury or death associated with such unintended or unauthorized use.

Vishay Semiconductor GmbH, P.O.B. 3535, D-74025 Heilbronn, Germany



## Disclaimer

All product specifications and data are subject to change without notice.

Vishay Intertechnology, Inc., its affiliates, agents, and employees, and all persons acting on its or their behalf (collectively, "Vishay"), disclaim any and all liability for any errors, inaccuracies or incompleteness contained herein or in any other disclosure relating to any product.

Vishay disclaims any and all liability arising out of the use or application of any product described herein or of any information provided herein to the maximum extent permitted by law. The product specifications do not expand or otherwise modify Vishay's terms and conditions of purchase, including but not limited to the warranty expressed therein, which apply to these products.

No license, express or implied, by estoppel or otherwise, to any intellectual property rights is granted by this document or by any conduct of Vishay.

The products shown herein are not designed for use in medical, life-saving, or life-sustaining applications unless otherwise expressly indicated. Customers using or selling Vishay products not expressly indicated for use in such applications do so entirely at their own risk and agree to fully indemnify Vishay for any damages arising or resulting from such use or sale. Please contact authorized Vishay personnel to obtain written terms and conditions regarding products designed for such applications.

Product names and markings noted herein may be trademarks of their respective owners.