

Linear Optocoupler, High Gain Stability, Wide Bandwidth

Features

- Couples AC and DC signals
- 0.01 % Servo Linearity
- Wide Bandwidth, > 200 kHz
- High Gain Stability, $\pm 0.05\%$ / °C
- Low Input-Output Capacitance
- Low Power Consumption, < 15 mW
- Isolation Test Voltage, 5300 V_{RMS}, 1.0 sec.
- Internal Insulation Distance, > 0.4 mm for VDE
- Component in accordance to RoHS 2002/95/EC and WEEE 2002/96/EC

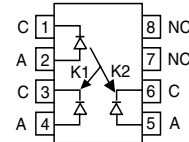
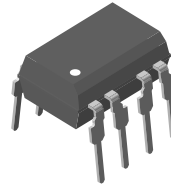

1179026

Agency Approvals

- UL File #E52744
- DIN EN 60747-5-2 (VDE0884)
DIN EN 60747-5-5 pending
Available with Option 1, Add -X001 Suffix

Applications

Power Supply Feedback Voltage/Current
Medical Sensor Isolation
Audio Signal Interfacing
Isolated Process Control Transducers
Digital Telephone Isolation

Description

The IL300 Linear Optocoupler consists of an AlGaAs IRLED irradiating an isolated feedback and an output PIN photodiode in a bifurcated arrangement. The feedback photodiode captures a percentage of the LED's flux and generates a control signal (I_{P1}) that can be used to servo the LED drive current. This technique compensates for the LED's non-linear, time, and temperature characteristics. The output PIN photodiode produces an output signal (I_{P2}) that is linearly related to the servo optical flux created by the LED.

The time and temperature stability of the input-output coupler gain ($K3$) is insured by using matched PIN photodiodes that accurately track the output flux of the LED.

Order Information

Part	Remarks
IL300	$K3 = 0.557 - 1.618$, DIP-8
IL300-DEFG	$K3 = 0.765 - 1.181$, DIP-8
IL300-EF	$K3 = 0.851 - 1.061$, DIP-8
IL300-E	$K3 = 0.851 - 0.955$, DIP-8
IL300-F	$K3 = 0.945 - 1.061$, DIP-8
IL300-X006	$K3 = 0.557 - 1.618$, DIP-8 400mil (option 6)
IL300-X007	$K3 = 0.557 - 1.618$, SMD-8 (option 7)
IL300-X009	$K3 = 0.557 - 1.618$, SMD-8 (option 9)
IL300-DEFG-X006	$K3 = 0.765 - 1.181$, DIP-8 400 mil (option 6)
IL300-DEFG-X007	$K3 = 0.765 - 1.181$, SMD-8 (option 7)
IL300-DEFG-X009	$K3 = 0.765 - 1.181$, SMD-8 (option 9)
IL300-EF-X006	$K3 = 0.851 - 1.061$, DIP-8 400 mil (option 6)
IL300-EF-X007	$K3 = 0.851 - 1.061$, SMD-8 (option 7)
IL300-EF-X009	$K3 = 0.851 - 1.061$, SMD-8 (option 9)
IL300-E-X006	$K3 = 0.851 - 0.955$, DIP-8 400 mil (option 6)
IL300-E-X007	$K3 = 0.851 - 0.955$, SMD-8 (option 7)
IL300-E-X009	$K3 = 0.851 - 0.955$, SMD-8 (option 9)
IL300-F-X006	$K3 = 0.945 - 1.061$, DIP-8 400 mil (option 6)
IL300-F-X007	$K3 = 0.945 - 1.061$, SMD-8 (option 7)
IL300-F-X009	$K3 = 0.945 - 1.061$, SMD-8 (option 9)

For additional information on the available options refer to Option Information.

Operation Description

A typical application circuit (Figure 1) uses an operational amplifier at the circuit input to drive the LED. The feedback photodiode sources current to R1 connected to the inverting input of U1. The photocurrent, I_{P1} , will be of a magnitude to satisfy the relationship of ($I_{P1} = V_{IN}/R1$).

The magnitude of this current is directly proportional to the feedback transfer gain (K1) times the LED drive current ($V_{IN}/R1 = K1 \cdot I_F$). The op-amp will supply LED current to force sufficient photocurrent to keep the node voltage (Vb) equal to Va.

The output photodiode is connected to a non-inverting voltage follower amplifier. The photodiode load resistor, R2, performs the current to voltage conversion. The output amplifier voltage is the product of the output forward gain (K2) times the LED current and photodiode load, R2 ($V_O = I_F \cdot K2 \cdot R2$).

Therefore, the overall transfer gain (V_O/V_{IN}) becomes the ratio of the product of the output forward gain (K2) times the photodiode load resistor (R2) to the product of the feedback transfer gain (K1) times the input resistor (R1). This reduces to $V_O/V_{IN} = (K2 \cdot R2)/(K1 \cdot R1)$.

The overall transfer gain is completely independent of the LED forward current. The IL300 transfer gain (K3) is expressed as the ratio of the output gain (K2) to the feedback gain (K1). This shows that the circuit gain becomes the product of the IL300 transfer gain times the ratio of the output to input resistors $V_O/V_{IN} = K3 (R2/R1)$.

K1-Servo Gain

The ratio of the input photodiode current (I_{P1}) to the LED current (I_F) i.e., $K1 = I_{P1}/I_F$.

K2-Forward Gain

The ratio of the output photodiode current (I_{P2}) to the LED current (I_F), i.e., $K2 = I_{P2}/I_F$.

K3-Transfer Gain

The Transfer Gain is the ratio of the Forward Gain to the Servo gain, i.e., $K3 = K2/K1$.

$\Delta K3$ -Transfer Gain Linearity

The percent deviation of the Transfer Gain, as a function of LED or temperature from a specific Transfer Gain at a fixed LED current and temperature.

Photodiode

A silicon diode operating as a current source. The output current is proportional to the incident optical flux supplied by the LED emitter. The diode is operated in the photovoltaic or photoconductive mode. In the photovoltaic mode the diode functions as a current source in parallel with a forward biased silicon diode.

The magnitude of the output current and voltage is dependent upon the load resistor and the incident LED optical flux. When operated in the photoconductive mode the diode is connected to a bias supply which reverse biases the silicon diode. The magnitude of the output current is directly proportional to the LED incident optical flux.

LED (Light Emitting Diode)

An infrared emitter constructed of AlGaAs that emits at 890 nm operates efficiently with drive current from 500 μA to 40 mA. Best linearity can be obtained at drive currents between 5.0 mA to 20 mA. Its output flux typically changes by - 0.5 % / $^{\circ}C$ over the above operational current range.

Application Circuit

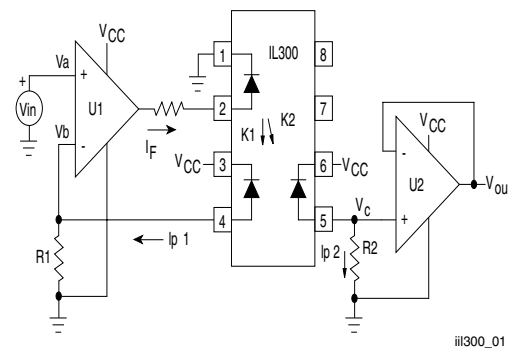

Figure 1. Typical Application Circuit

Absolute Maximum Ratings

$T_{amb} = 25\text{ }^{\circ}\text{C}$, unless otherwise specified

Stresses in excess of the absolute Maximum Ratings can cause permanent damage to the device. Functional operation of the device is not implied at these or any other conditions in excess of those given in the operational sections of this document. Exposure to absolute Maximum Rating for extended periods of the time can adversely affect reliability.

Input

Parameter	Test condition	Symbol	Value	Unit
Power dissipation		P_{diss}	160	mW
Derate linearly from 25 °C			2.13	mW/°C
Forward current		I_F	60	mA
Surge current (pulse width < 10 μs)		I_{PK}	250	mA
Reverse voltage		V_R	5.0	V
Thermal resistance		R_{th}	470	K/W
Junction temperature		T_j	100	°C

Output

Parameter	Test condition	Symbol	Value	Unit
Power dissipation		P_{diss}	50	mA
Derate linearly from 25 °C			0.65	mW/°C
Reverse voltage		V_R	50	V
Junction temperature		T_j	100	°C
Thermal resistance		R_{th}	1500	K/W

Coupler

Parameter	Test condition	Symbol	Value	Unit
Total package dissipation at 25 °C		P_{tot}	210	mW
Derate linearly from 25 °C			2.8	mW/°C
Storage temperature		T_{stg}	- 55 to + 150	°C
Operating temperature		T_{amb}	- 55 to + 100	°C
Isolation test voltage			> 5300	V_{RMS}
Isolation resistance	$V_{IO} = 500\text{ V}$, $T_{amb} = 25\text{ }^{\circ}\text{C}$	R_{IO}	> 10^{12}	Ω
	$V_{IO} = 500\text{ V}$, $T_{amb} = 100\text{ }^{\circ}\text{C}$	R_{IO}	> 10^{11}	Ω

Electrical Characteristics

$T_{amb} = 25\text{ }^{\circ}\text{C}$, unless otherwise specified

Minimum and maximum values are testing requirements. Typical values are characteristics of the device and are the result of engineering evaluation. Typical values are for information only and are not part of the testing requirements.

Input

LED Emitter

Parameter	Test condition	Symbol	Min	Typ.	Max	Unit
Forward voltage	$I_F = 10\text{ mA}$	V_F		1.25	1.50	V
V_F Temperature coefficient		$\Delta V_F / \Delta\text{ }^{\circ}\text{C}$		- 2.2		mV/ $^{\circ}\text{C}$
Reverse current	$V_R = 5\text{ V}$	I_R		1.0		μA
Junction capacitance	$V_F = 0\text{ V}$, $f = 1.0\text{ MHz}$	C_j		15		pF
Dynamic resistance	$I_F = 10\text{ mA}$	$\Delta V_F / \Delta I_F$		6.0		Ω

Output

Parameter	Test condition	Symbol	Min	Typ.	Max	Unit
Dark current	$V_{det} = -15\text{ V}$, $I_F = 0\text{ }\mu\text{s}$	I_D		1.0	25	nA
Open circuit voltage	$I_F = 10\text{ mA}$	V_D		500		mV
Short circuit current	$I_F = 10\text{ mA}$	I_{SC}		70		μA
Junction capacitance	$V_F = 0$, $f = 1.0\text{ MHz}$	C_j		12		pF
Noise equivalent power	$V_{det} = 15\text{ V}$	NEP		4×10^{14}		W/ $\sqrt{\text{Hz}}$

Coupler

Parameter	Test condition	Symbol	Min	Typ.	Max	Unit
Input- output capacitance	$V_F = 0 \text{ V}$, $f = 1.0 \text{ MHz}$			1.0		pF
K1, Servo gain (I_{P1}/I_F)	$I_F = 10 \text{ mA}$, $V_{det} = -15 \text{ V}$	K1	0.0050	0.007	0.011	
Servo current, see Note 1,2	$I_F = 10 \text{ mA}$, $V_{det} = -15 \text{ V}$	I_{P1}		70		μA
K2, Forward gain (I_{P2}/I_F)	$I_F = 10 \text{ mA}$, $V_{det} = -15 \text{ V}$	K2	0.0036	0.007	0.011	
Forward current	$I_F = 10 \text{ mA}$, $V_{det} = -15 \text{ V}$	I_{P2}		70		μA
K3, Transfer gain (K2/K1) see Note 1,2	$I_F = 10 \text{ mA}$, $V_{det} = -15 \text{ V}$	K3	0.56	1.00	1.65	K2/K1
Transfer gain linearity	$I_F = 1.0 \text{ to } 10 \text{ mA}$	$\Delta K3$		± 0.25		%
	$I_F = 1.0 \text{ to } 10 \text{ mA}$, $T_{amb} = 0 \text{ }^\circ\text{C to } 75 \text{ }^\circ\text{C}$			± 0.5		%
Photoconductive Operation						
Frequency response	$I_{Fq} = 10 \text{ mA}$, $\text{MOD} = \pm 4.0 \text{ mA}$, $R_L = 50 \text{ } \Omega$	BW (-3 db)		200		KHz
Phase response at 200 kHz	$V_{det} = -15 \text{ V}$			-45		Deg.

1. Bin Sorting:

K3 (transfer gain) is sorted into bins that are $\pm 6\%$, as follows:

Bin A = 0.557 - 0.626

Bin B = 0.620 - 0.696

Bin C = 0.690 - 0.773

Bin D = 0.765 - 0.859

Bin E = 0.851 - 0.955

Bin F = 0.945 - 1.061

Bin G = 1.051 - 1.181

Bin H = 1.169 - 1.311

Bin I = 1.297 - 1.456

Bin J = 1.442 - 1.618

K3 = K2/K1. K3 is tested at $I_F = 10 \text{ mA}$, $V_{det} = -15 \text{ V}$.

2. Bin Categories: All IL300s are sorted into a K3 bin, indicated by an alpha character that is marked on the part. The bins range from "A" through "J".

The IL300 is shipped in tubes of 50 each. Each tube contains only one category of K3. The category of the parts in the tube is marked on the tube label as well as on each individual part.

3. Category Options: Standard IL300 orders will be shipped from the categories that are available at the time of the order. Any of the ten categories may be shipped. For customers requiring a narrower selection of bins, four different bin option parts are offered.

IL300-DEFG: Order this part number to receive categories D,E,F,G only.

IL300-EF: Order this part number to receive categories E, F only.

IL300-E: Order this part number to receive category E only.

Switching Characteristics

Parameter	Test condition	Symbol	Min	Typ.	Max	Unit
Switching time	$\Delta I_F = 2.0 \text{ mA}$, $I_{Fq} = 10 \text{ mA}$	t_r		1.0		μs
		t_f		1.0		μs
Rise time		t_r		1.75		μs
Fall time		t_f		1.75		μs

Common Mode Transient Immunity

Parameter	Test condition	Symbol	Min	Typ.	Max	Unit
Common mode capacitance	$V_F = 0, f = 1. \text{ MHz}$	C_{CM}		0.5		pF
Common mode rejection ratio	$f = 60 \text{ Hz}, R_L = 2.2 \text{ K}\Omega$	CMRR		130		dB

Typical Characteristics ($T_{amb} = 25^\circ\text{C}$ unless otherwise specified)

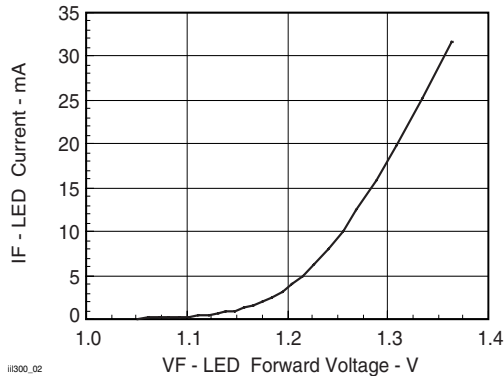

Figure 2. LED Forward Current vs. Forward Voltage

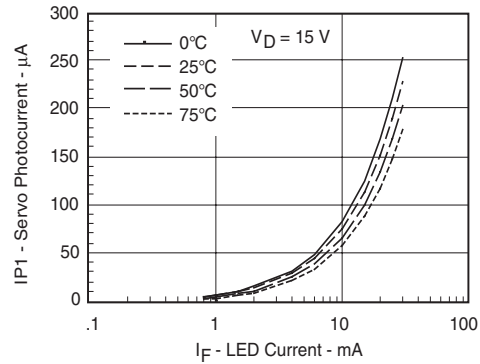

Figure 4. Servo Photocurrent vs. LED Current and Temperature

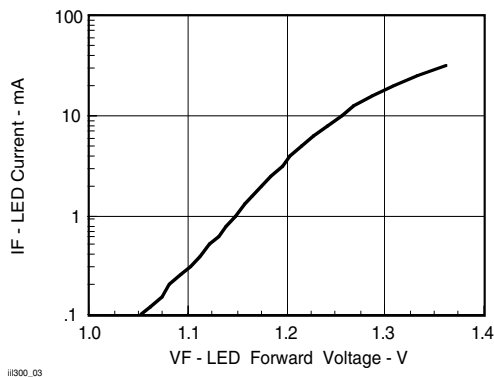

Figure 3. LED Forward Current vs. Forward Voltage

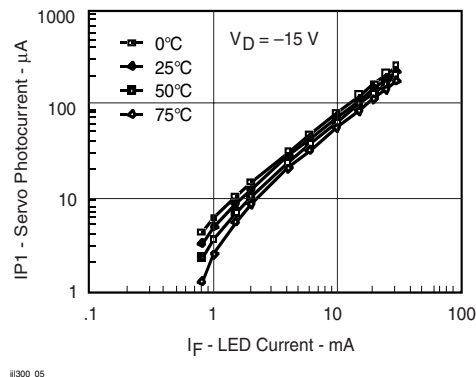
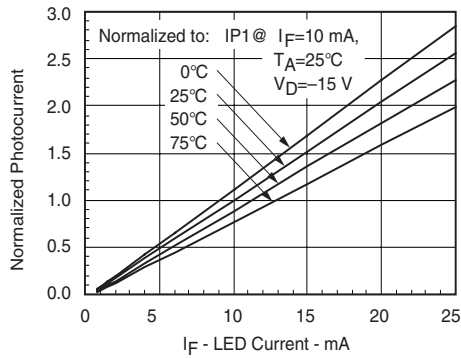
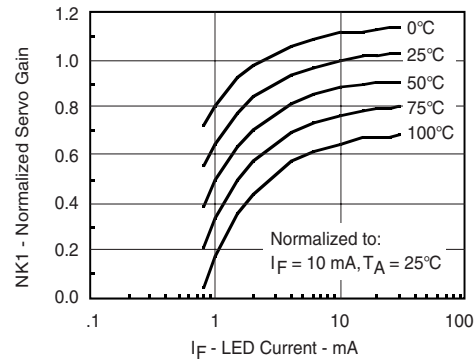

Figure 5. Servo Photocurrent vs. LED Current and Temperature



IL300_06

Figure 6. Normalized Servo Photocurrent vs. LED Current and Temperature



IL300_09

Figure 9. Normalized Servo Gain vs. LED Current and Temperature

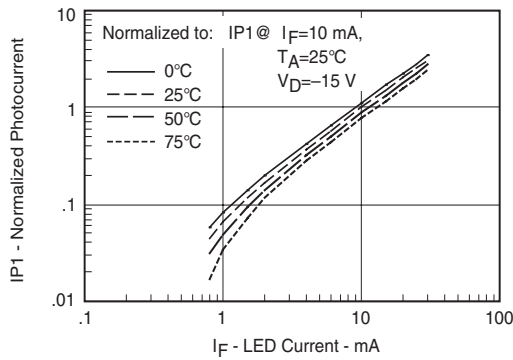

IL300_07

Figure 7. Normalized Servo Photocurrent vs. LED Current and Temperature

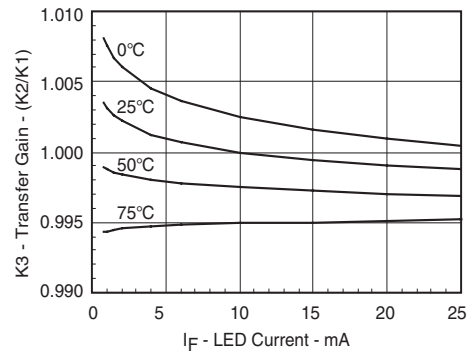

IL300_10

Figure 10. Transfer Gain vs. LED Current and Temperature

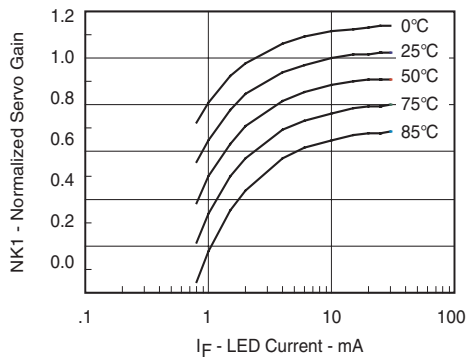

IL300_08

Figure 8. Servo Gain vs. LED Current and Temperature

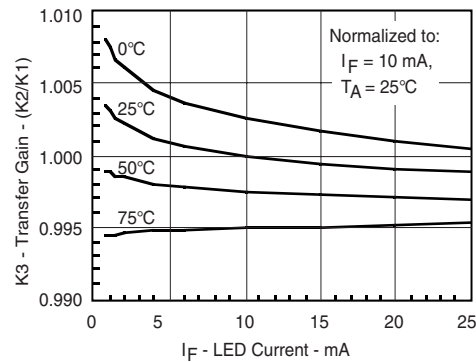

IL300_11

Figure 11. Normalized Transfer Gain vs. LED Current and Temperature

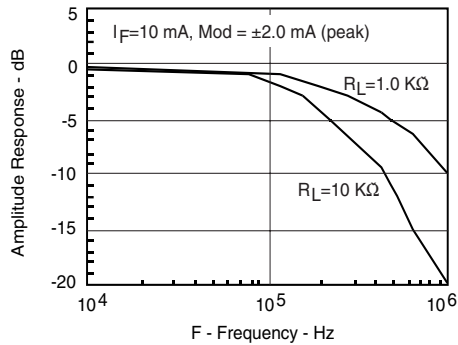

il300_12

Figure 12. Amplitude Response vs. Frequency

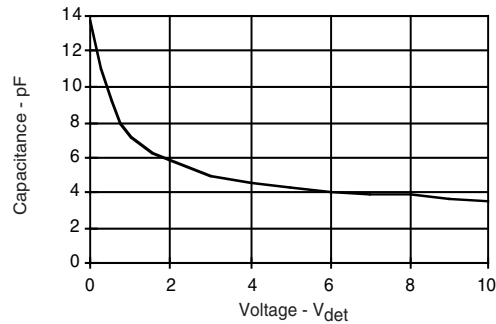

il300_15

Figure 15. Photodiode Junction Capacitance vs. Reverse Voltage

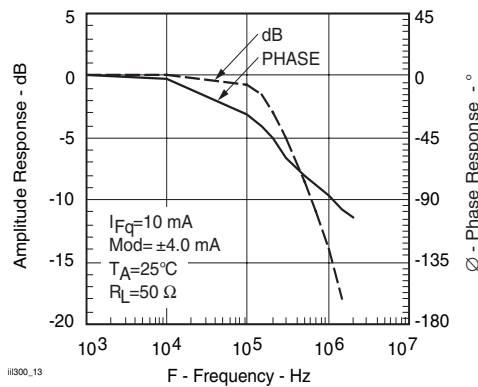

il300_13

Figure 13. Amplitude and Phase Response vs. Frequency

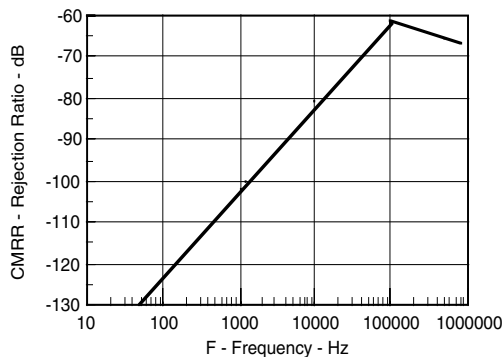

il300_14

Figure 14. Common-Mode Rejection

Application Considerations

In applications such as monitoring the output voltage from a line powered switch mode power supply, measuring bioelectric signals, interfacing to industrial transducers, or making floating current measurements, a galvanically isolated, DC coupled interface is often essential. The IL300 can be used to construct an amplifier that will meet these needs.

The IL300 eliminates the problems of gain nonlinearity and drift induced by time and temperature, by monitoring LED output flux.

A PIN photodiode on the input side is optically coupled to the LED and produces a current directly proportional to flux falling on it. This photocurrent, when coupled to an amplifier, provides the servo signal that controls the LED drive current.

The LED flux is also coupled to an output PIN photodiode. The output photodiode current can be directly or amplified to satisfy the needs of succeeding circuits.

Isolated Feedback Amplifier

The IL300 was designed to be the central element of DC coupled isolation amplifiers. Designing the IL300 into an amplifier that provides a feedback control signal for a line powered switch mode power is quite simple, as the following example will illustrate.

See Figure 17 for the basic structure of the switch mode supply using the Infineon TDA4918 Push-Pull Switched Power Supply Control Chip. Line isolation and insulation is provided by the high frequency transformer. The voltage monitor isolation will be provided by the IL300.

The isolated amplifier provides the PWM control signal which is derived from the output supply voltage. Figure 16 more closely shows the basic function of the amplifier.

The control amplifier consists of a voltage divider and a non-inverting unity gain stage. The TDA4918 data sheet indicates that an input to the control amplifier is a high quality operational amplifier that typically requires a +3.0 V signal. Given this information, the amplifier circuit topology shown in Figure 18 is selected.

The power supply voltage is scaled by R1 and R2 so that there is + 3.0 V at the non-inverting input (Va) of U1. This voltage is offset by the voltage developed by photocurrent flowing through R3. This photocurrent is developed by the optical flux created by current flowing through the LED. Thus as the scaled monitor voltage (Va) varies it will cause a change in the LED current necessary to satisfy the differential voltage needed across R3 at the inverting input.

The first step in the design procedure is to select the value of R3 given the LED quiescent current (IFq) and the servo gain (K1). For this design, IFq = 12 mA. Figure 4 shows the servo photocurrent at IFq is found to be 100 µA. With this data R3 can be calculated.

$$R3 = \frac{V_b}{I_{PI}} = \frac{3V}{100 \mu A} = 30 K\Omega \quad 17164$$

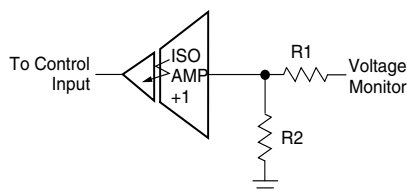

iii300_16

Figure 16. Isolated Control Amplifier

For best input offset compensation at U1, R2 will equal R3. The value of R1 can easily be calculated from the following.

$$R1 = R2 \left(\frac{V_{MONITOR}}{V_a} - 1 \right) \quad 17165$$

The value of R5 depends upon the IL300 Transfer Gain (K3). K3 is targeted to be a unit gain device, however to minimize the part to part Transfer Gain variation, Infineon offers K3 graded into ± 5 % bins. R5 can determined using the following equation,

$$R5 = \frac{V_{OUT}}{V_{MONITOR}} \cdot \frac{R3(R1 + R2)}{R2K3} \quad 17166$$

Or if a unity gain amplifier is being designed (VMONITOR = VOUT, R1 = 0), the equation simplifies to:

$$R5 = \frac{R3}{K3} \quad 17190$$

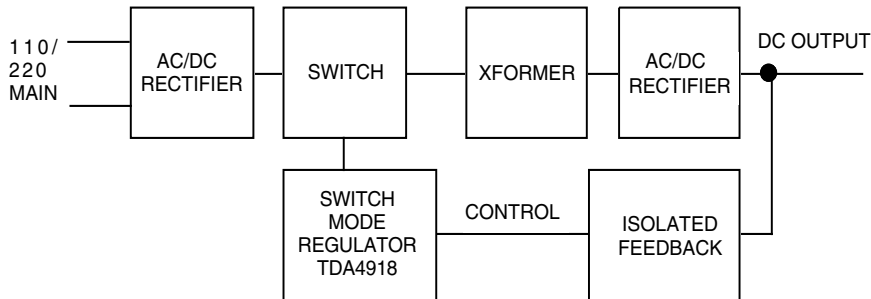

iii300_17

Figure 17. Switching Mode Power Supply

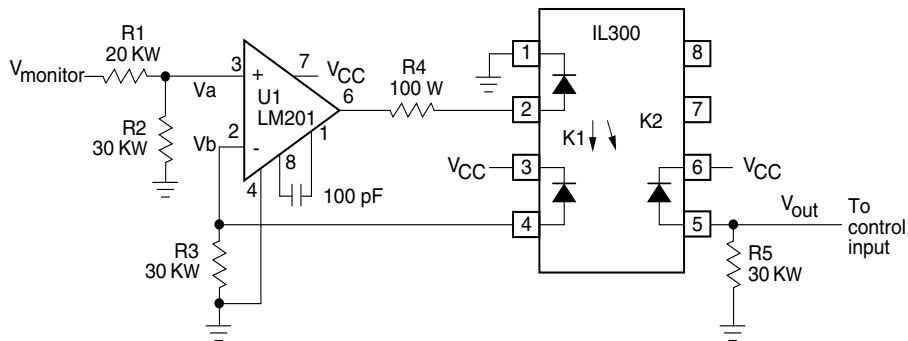

iii300_18

Figure 18. DC Coupled Power Supply Feedback Amplifier

Table 1. gives the value of R5 given the production K3 bins.

R5 Selection

Table 1.

Bins	Min.	Max.	3 Typ.	R5 Resistor KΩ	1% KΩ
A	0.560	0.623	0.59	50.85	51.1
B	0.623	0.693	0.66	45.45	45.3
C	0.693	0.769	0.73	41.1	41.2
D	0.769	0.855	0.81	37.04	37.4
E	0.855	0.950	0.93	32.26	32.4
F	0.950	1.056	1.00	30.00	30.0
G	1.056	1.175	1.11	27.03	27.0
H	1.175	1.304	1.24	24.19	24.0
I	1.304	1.449	1.37	21.90	22.0
J	1.449	1.610	1.53	19.61	19.4

The last step in the design is selecting the LED current limiting resistor (R4). The output of the operational amplifier is targeted to be 50 % of the V_{CC} , or 2.5 V. With an LED quiescent current of 12 mA the typical LED (V_F) is 1.3 V. Given this and the operational output voltage, R4 can be calculated.

$$R4 = \frac{V_{opamp} - V_F}{I_{Fq}} = \frac{2.5 \text{ V} - 1.3 \text{ V}}{12 \text{ mA}} = 100\Omega \quad 17096$$

The circuit was constructed with an LM201 differential operational amplifier using the resistors selected. The amplifier was compensated with a 100 pF capacitor connected between pins 1 and 8.

The DC transfer characteristics are shown in Figure 19. The amplifier was designed to have a gain of 0.6 and was measured to be 0.6036. Greater accuracy can be achieved by adding a balancing circuit, and potentiometer in the input divider, or at R5. The circuit shows exceptionally good gain linearity with an RMS error of only 0.0133 % over the input voltage range of 4.0 V - 6.0 V in a servo mode; see Figure 20.

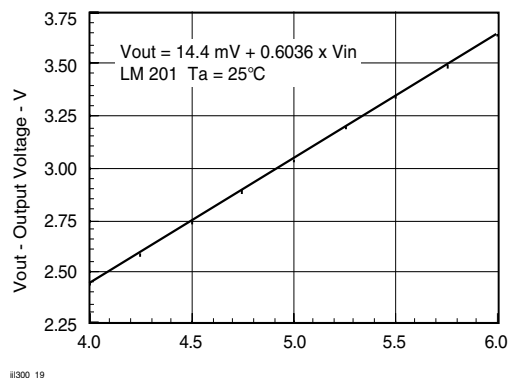

Figure 19. Transfer Gain

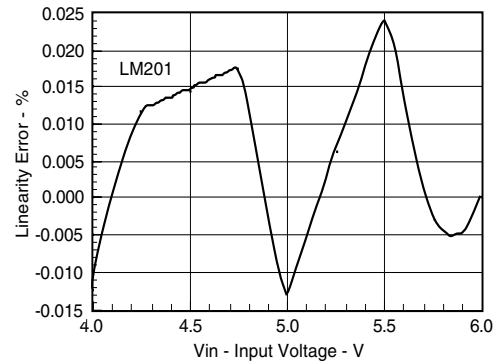

Figure 20. Linearity Error vs. Input Voltage

The AC characteristics are also quite impressive offering a -3.0 dB bandwidth of 100 kHz, with a -45° phase shift at 80 kHz as shown in Figure 21.

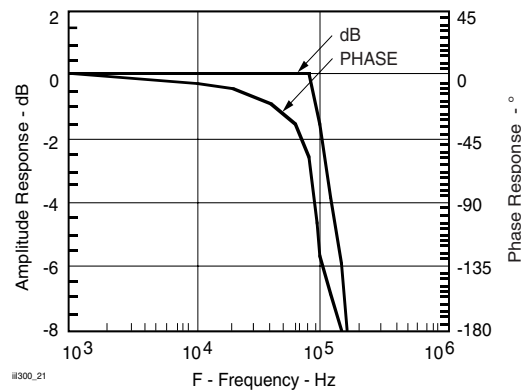

Figure 21. Amplitude and Phase Power Supply Control

The same procedure can be used to design isolation amplifiers that accept bipolar signals referenced to ground. These amplifiers circuit configurations are shown in Figure 22. In order for the amplifier to respond to a signal that swings above and below ground, the LED must be pre biased from a separate source by using a voltage reference source (V_{ref1}). In these designs, R3 can be determined by the following equation.

$$R3 = \frac{V_{ref1}}{I_{P1}} = \frac{V_{ref1}}{K1I_{Fq}} \quad 17098$$

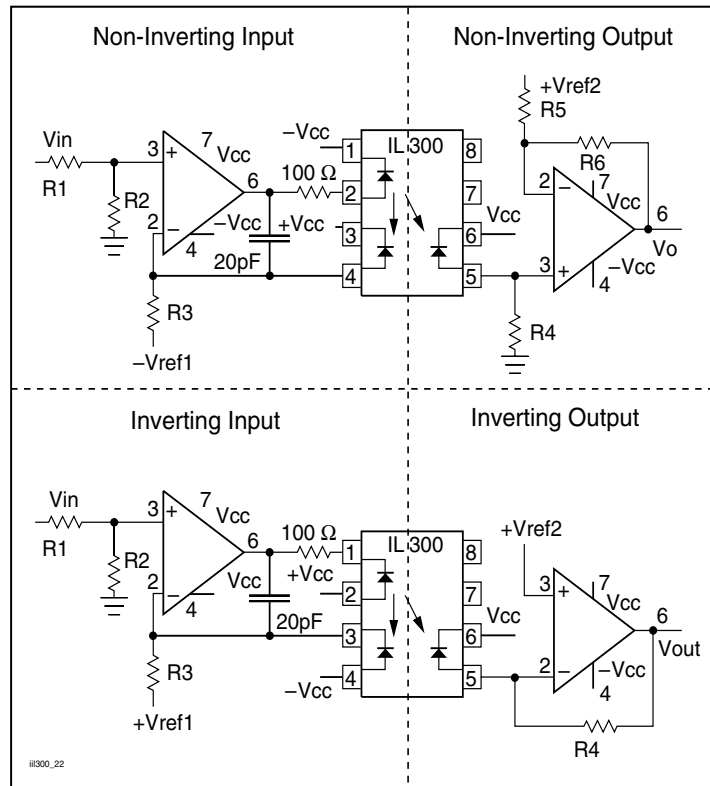

Figure 22. Non-inverting and Inverting Amplifiers

Table 2. Optolinear amplifiers

Amplifier	Input	Output	Gain	Offset
Non-Inverting	Inverting	Inverting	$V_{OUT} = \frac{K3 R4 R2}{R3 (R1 + R2)}$	$V_{ref2} = \frac{V_{ref1} R4 K3}{R3}$
	Non-Inverting	Non-Inverting	$V_{OUT} = \frac{K3 R4 R2 (R5 + R6)}{R3 R5 (R1 + R2)}$	$V_{ref2} = \frac{-V_{ref1} R4 (R5 + R6) K3}{R3 R6}$
Inverting	Inverting	Non-Inverting	$V_{OUT} = \frac{-K3 R4 R2 (R5 + R6)}{R3 R5 (R1 + R2)}$	$V_{ref2} = \frac{V_{ref1} R4 (R5 + R6) K3}{R3 R6}$
	Non-Inverting	Inverting	$V_{OUT} = \frac{-K3 R4 R2}{R3 (R1 + R2)}$	$V_{ref2} = \frac{-V_{ref1} R4 K3}{R3}$

17189

These amplifiers provide either an inverting or non-inverting transfer gain based upon the type of input and output amplifier. Table 2 shows the various configurations along with the specific transfer gain equations. The offset column refers to the calculation of the output offset or V_{ref2} necessary to provide a zero volt-

age output for a zero voltage input. The non-inverting input amplifier requires the use of a bipolar supply, while the inverting input stage can be implemented with single supply operational amplifiers that permit operation close to ground.

For best results, place a buffer transistor between the LED and output of the operational amplifier when a CMOS opamp is used or the LED I_{Fq} drive is targeted to operate beyond 15 mA. Finally the bandwidth is

influenced by the magnitude of the closed loop gain of the input and output amplifiers. Best bandwidths result when the amplifier gain is designed for unity.

Package Dimensions in Inches (mm)

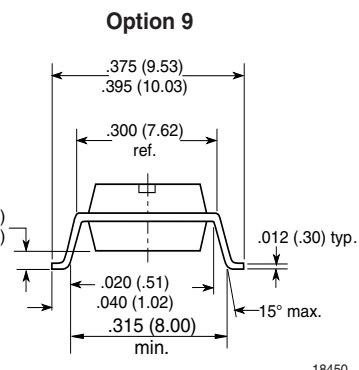
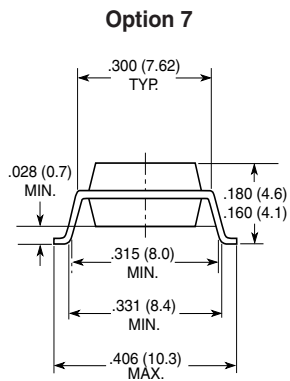
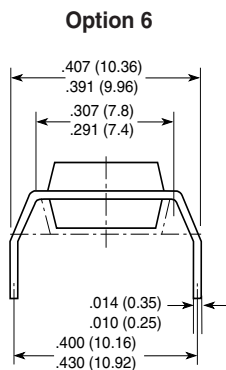
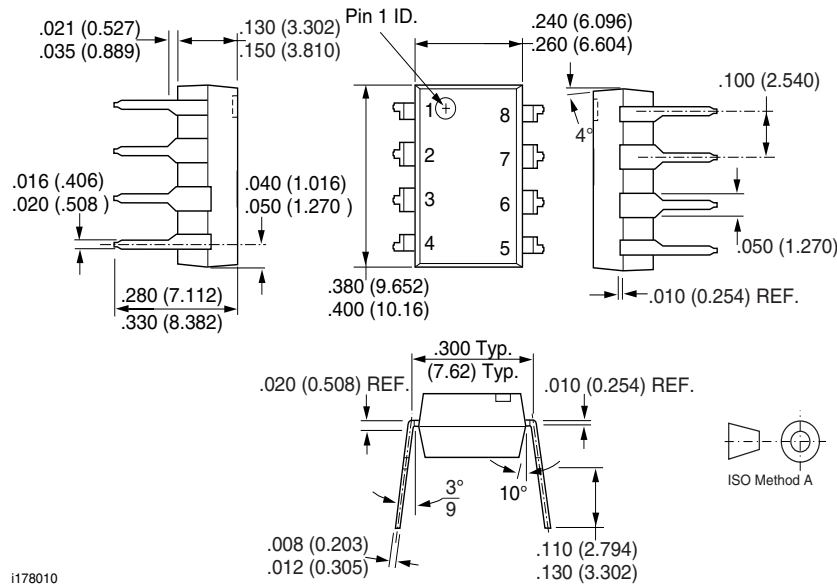

Ozone Depleting Substances Policy Statement

It is the policy of Vishay Semiconductor GmbH to

1. Meet all present and future national and international statutory requirements.
2. Regularly and continuously improve the performance of our products, processes, distribution and operating systems with respect to their impact on the health and safety of our employees and the public, as well as their impact on the environment.

It is particular concern to control or eliminate releases of those substances into the atmosphere which are known as ozone depleting substances (ODSs).

The Montreal Protocol (1987) and its London Amendments (1990) intend to severely restrict the use of ODSs and forbid their use within the next ten years. Various national and international initiatives are pressing for an earlier ban on these substances.

Vishay Semiconductor GmbH has been able to use its policy of continuous improvements to eliminate the use of ODSs listed in the following documents.

1. Annex A, B and list of transitional substances of the Montreal Protocol and the London Amendments respectively
2. Class I and II ozone depleting substances in the Clean Air Act Amendments of 1990 by the Environmental Protection Agency (EPA) in the USA
3. Council Decision 88/540/EEC and 91/690/EEC Annex A, B and C (transitional substances) respectively.

Vishay Semiconductor GmbH can certify that our semiconductors are not manufactured with ozone depleting substances and do not contain such substances.

We reserve the right to make changes to improve technical design and may do so without further notice.

Parameters can vary in different applications. All operating parameters must be validated for each customer application by the customer. Should the buyer use Vishay Semiconductors products for any unintended or unauthorized application, the buyer shall indemnify Vishay Semiconductors against all claims, costs, damages, and expenses, arising out of, directly or indirectly, any claim of personal damage, injury or death associated with such unintended or unauthorized use.

Vishay Semiconductor GmbH, P.O.B. 3535, D-74025 Heilbronn, Germany



Disclaimer

All product specifications and data are subject to change without notice.

Vishay Intertechnology, Inc., its affiliates, agents, and employees, and all persons acting on its or their behalf (collectively, "Vishay"), disclaim any and all liability for any errors, inaccuracies or incompleteness contained herein or in any other disclosure relating to any product.

Vishay disclaims any and all liability arising out of the use or application of any product described herein or of any information provided herein to the maximum extent permitted by law. The product specifications do not expand or otherwise modify Vishay's terms and conditions of purchase, including but not limited to the warranty expressed therein, which apply to these products.

No license, express or implied, by estoppel or otherwise, to any intellectual property rights is granted by this document or by any conduct of Vishay.

The products shown herein are not designed for use in medical, life-saving, or life-sustaining applications unless otherwise expressly indicated. Customers using or selling Vishay products not expressly indicated for use in such applications do so entirely at their own risk and agree to fully indemnify Vishay for any damages arising or resulting from such use or sale. Please contact authorized Vishay personnel to obtain written terms and conditions regarding products designed for such applications.

Product names and markings noted herein may be trademarks of their respective owners.