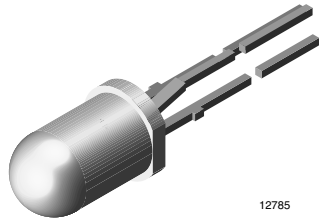


Silicon NPN Phototransistor, RoHS Compliant



DESCRIPTION

BPV11 is a silicon NPN phototransistor with high radiant sensitivity in clear, T-1 $\frac{3}{4}$ plastic package with base terminal. It is sensitive to visible and near infrared radiation.

FEATURES

- Package type: leaded
- Package form: T-1 $\frac{3}{4}$
- Dimensions (in mm): \varnothing 5
- High photo sensitivity
- High radiant sensitivity
- Suitable for visible and near infrared radiation
- Fast response times
- Angle of half sensitivity: $\varphi = \pm 15^\circ$
- Base terminal connected
- Lead (Pb)-free component in accordance with RoHS 2002/95/EC and WEEE 2002/96/EC



RoHS
COMPLIANT

APPLICATIONS

- Detector for industrial electronic circuitry, measurement and control

PRODUCT SUMMARY

COMPONENT	I_{ca} (mA)	φ (deg)	$\lambda_{0.1}$ (nm)
BPV11	10	± 15	450 to 1080

Note

Test condition see table "Basic Characteristics"

ORDERING INFORMATION

ORDERING CODE	PACKAGING	REMARKS	PACKAGE FORM
BPV11	Bulk	MOQ: 3000 pcs, 3000 pcs/bulk	T-1 $\frac{3}{4}$

Note

MOQ: minimum order quantity

ABSOLUTE MAXIMUM RATINGS

PARAMETER	TEST CONDITION	SYMBOL	VALUE	UNIT
Collector base voltage		V_{CBO}	80	V
Collector emitter voltage		V_{CEO}	70	V
Emitter base voltage		V_{EBO}	5	V
Collector current		I_C	50	mA
Collector peak current	$t_p/T = 0.5, t_p \leq 10$ ms	I_{CM}	100	mA
Power dissipation	$T_{amb} \leq 47^\circ\text{C}$	P_V	150	mW
Junction temperature		T_j	100	$^\circ\text{C}$
Operating temperature range		T_{amb}	- 40 to + 100	$^\circ\text{C}$
Storage temperature range		T_{stg}	- 40 to + 100	$^\circ\text{C}$
Soldering temperature	$t \leq 5$ s, 2 mm from body	T_{sd}	260	$^\circ\text{C}$
Thermal resistance junction/ambient	Connected with Cu wire, 0.14 mm ²	R_{thJA}	350	K/W

Note

$T_{amb} = 25^\circ\text{C}$, unless otherwise specified

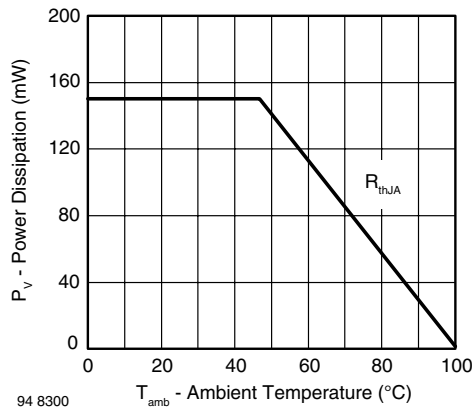


Fig. 1 - Power Dissipation Limit vs. Ambient Temperature

BASIC CHARACTERISTICS						
PARAMETER	TEST CONDITION	SYMBOL	MIN.	TYP.	MAX.	UNIT
Collector emitter breakdown voltage	$I_C = 1 \text{ mA}$	$V_{(BR)CEO}$	70			V
Collector emitter dark current	$V_{CE} = 10 \text{ V}, E = 0$	I_{CEO}		1	50	nA
DC current gain	$V_{CE} = 5 \text{ V}, I_C = 5 \text{ mA}, E = 0$	h_{FE}		450		
Collector emitter capacitance	$V_{CE} = 0 \text{ V}, f = 1 \text{ MHz}, E = 0$	C_{CEO}		15		pF
Collector base capacitance	$V_{BE} = 0 \text{ V}, f = 1 \text{ MHz}, E = 0$	C_{CBO}		19		pF
Collector light current	$E_e = 1 \text{ mW/cm}^2, \lambda = 950 \text{ nm}, V_{CE} = 5 \text{ V}$	I_{ca}	3	10		mA
Angle of half sensitivity		φ		± 15		deg
Wavelength of peak sensitivity		λ_p		850		nm
Range of spectral bandwidth		$\lambda_{0.1}$		450 to 1080		nm
Collector emitter saturation voltage	$E_e = 1 \text{ mW/cm}^2, \lambda = 950 \text{ nm}, I_C = 1 \text{ mA}$	V_{CEsat}		130	300	mV
Turn-on time	$V_S = 5 \text{ V}, I_C = 5 \text{ mA}, R_L = 100 \Omega$	t_{on}		6		μs
Turn-off time	$V_S = 5 \text{ V}, I_C = 5 \text{ mA}, R_L = 100 \Omega$	t_{off}		5		μs
Cut-off frequency	$V_S = 5 \text{ V}, I_C = 5 \text{ mA}, R_L = 100 \Omega$	f_c		110		kHz

Note
 $T_{amb} = 25 \text{ }^\circ\text{C}$, unless otherwise specified

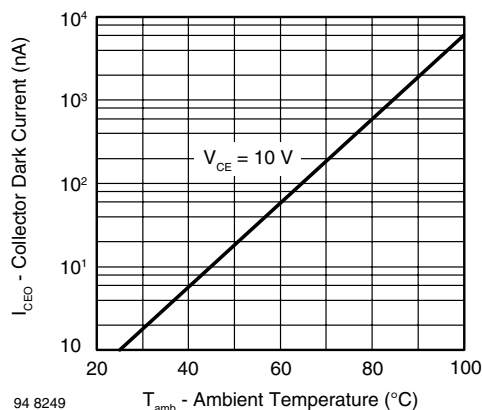
BASIC CHARACTERISTICS
 $T_{amb} = 25 \text{ }^\circ\text{C}$, unless otherwise specified


Fig. 2 - Collector Dark Current vs. Ambient Temperature

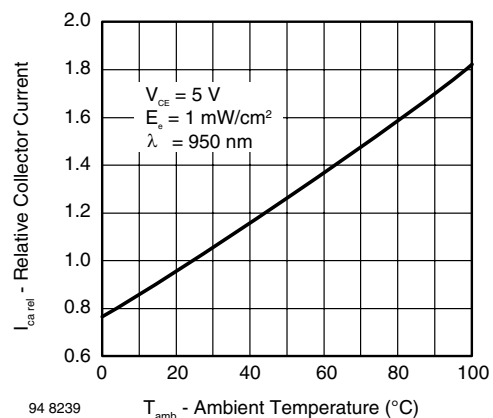


Fig. 3 - Relative Collector Current vs. Ambient Temperature

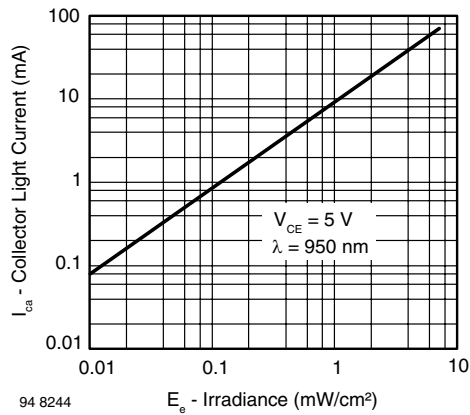


Fig. 4 - Collector Light Current vs. Irradiance

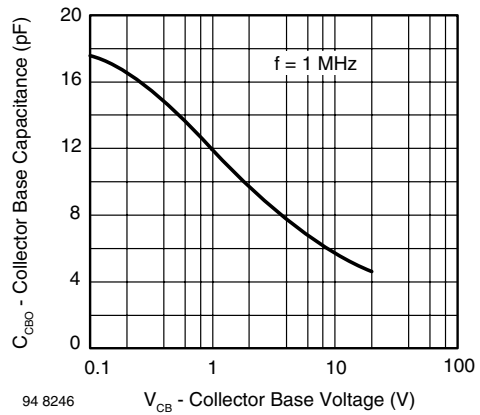


Fig. 7 - Collector Base Capacitance vs. Collector Base Voltage

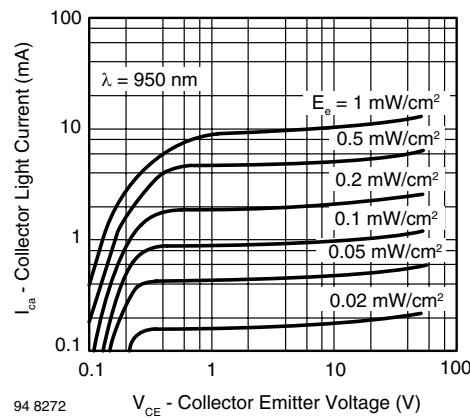


Fig. 5 - Collector Light Current vs. Collector Emitter Voltage

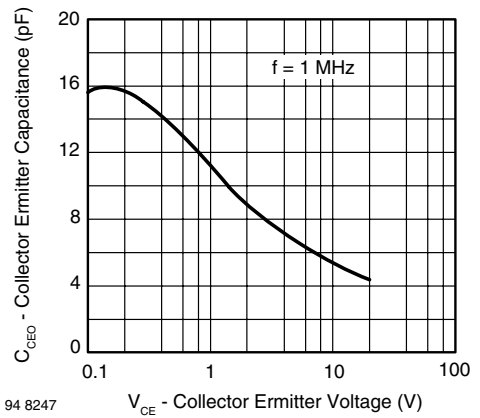


Fig. 8 - Collector Emitter Capacitance vs. Collector Emitter Voltage

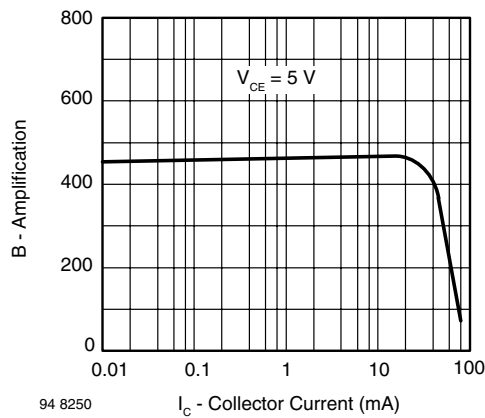


Fig. 6 - Amplification vs. Collector Current

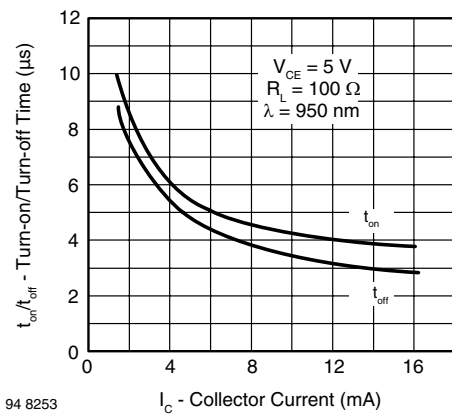


Fig. 9 - Turn-on/Turn-off Time vs. Collector Current

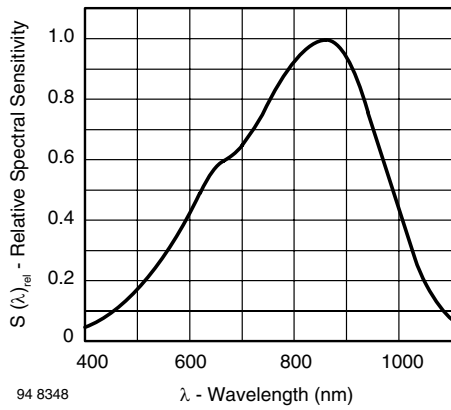


Fig. 10 - Relative Spectral Sensitivity vs. Wavelength

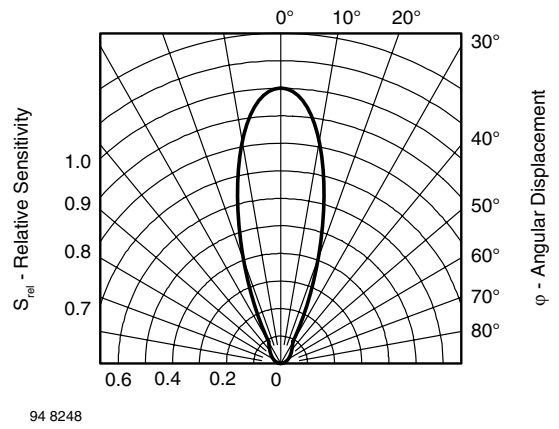
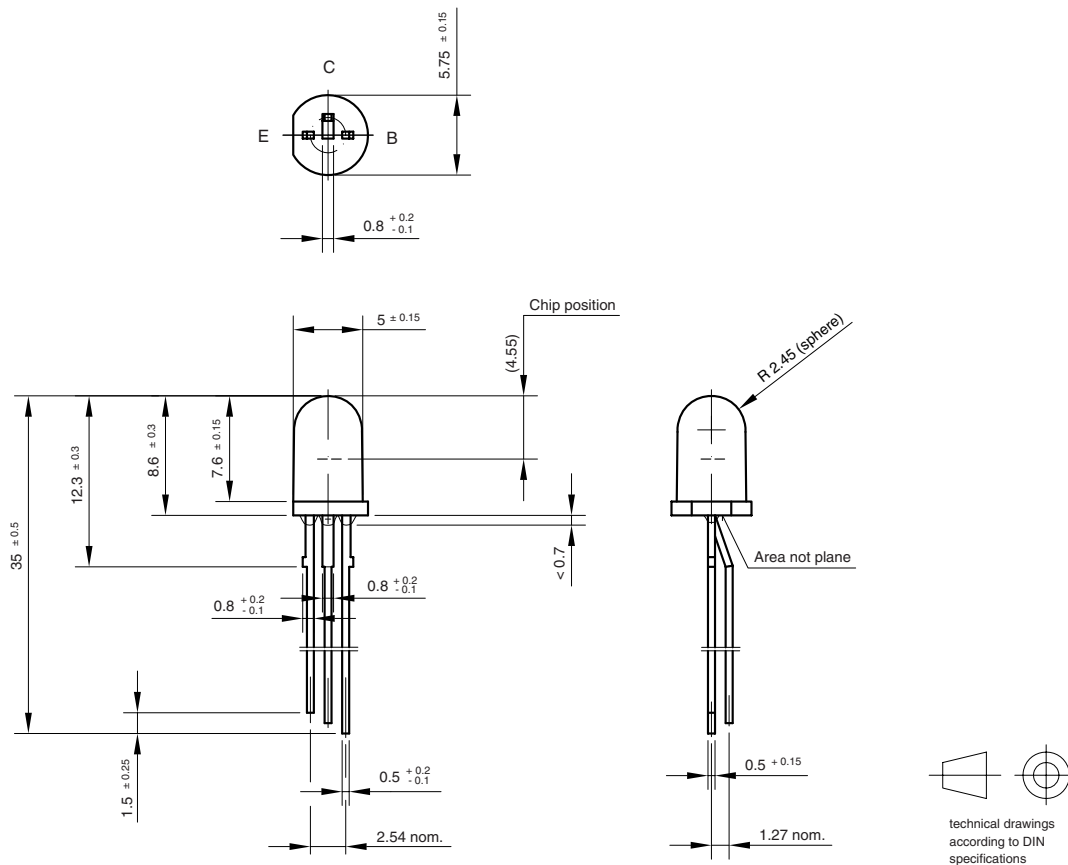


Fig. 11 - Relative Radiant Sensitivity vs. Angular Displacement

PACKAGE DIMENSIONS in millimeters


Drawing-No.: 6.544-5188.01-4
 Issue:1; 01.07.96
 96 12200



Disclaimer

All product specifications and data are subject to change without notice.

Vishay Intertechnology, Inc., its affiliates, agents, and employees, and all persons acting on its or their behalf (collectively, "Vishay"), disclaim any and all liability for any errors, inaccuracies or incompleteness contained herein or in any other disclosure relating to any product.

Vishay disclaims any and all liability arising out of the use or application of any product described herein or of any information provided herein to the maximum extent permitted by law. The product specifications do not expand or otherwise modify Vishay's terms and conditions of purchase, including but not limited to the warranty expressed therein, which apply to these products.

No license, express or implied, by estoppel or otherwise, to any intellectual property rights is granted by this document or by any conduct of Vishay.

The products shown herein are not designed for use in medical, life-saving, or life-sustaining applications unless otherwise expressly indicated. Customers using or selling Vishay products not expressly indicated for use in such applications do so entirely at their own risk and agree to fully indemnify Vishay for any damages arising or resulting from such use or sale. Please contact authorized Vishay personnel to obtain written terms and conditions regarding products designed for such applications.

Product names and markings noted herein may be trademarks of their respective owners.