

Home > 6092212130F

Part Number: **6092212130F**

### General Description

Color	 Green
Series	609
Description	Green LED 9mm Mounting Hole Indicator
Housing	Chrome Plated Brass
Lamp Type	Single Color
Mounting Method	Lock Washer and Nut
Compliance	Front of Panel
Termination	Solder Blade
Mounting Hole Size	.366"
Metal Finish Desc	Chrome
Panel Thickness	.295"
LED Position	Recess
Luminous Intensity Typical	110
Forward Current mA	15 mA
Voltage	12 VDC
Operating Temperature	-25 +85
Storage Temperature	-25 +100

# Dialight

## 609 Series

### LED Panel Mount Indicators for 9mm Mounting Hole



#### FEATURES / BENEFITS

- ▲ RoHS compliant
- ▲ Long Life - typically 100K hours
- ▲ Low power consumption - uses up to 90% less energy than an incandescent indicator
- ▲ No heat generated
- ▲ Colors include red, green, and yellow
- ▲ Front panel mounting
- ▲ LED can be recessed or protrude from housing

#### APPLICATIONS

Dialight's 600 series of metric indicators are designed for a variety of applications such as:

- Main and remote power indication
- Status Indication
- Maintenance and warning indication
- Instrumentation
- ...and many more!

#### SPECIFICATIONS

- ▲ Voltage requirements: 6, 12 and 24 VDC (no resistor required)
- ▲ Electrical connection through solder terminals
- ▲ Mounting hole size: 0.366 inches [9.3 mm]
- ▲ Maximum panel thickness: 0.295 inches [7.5 mm]
- ▲ Mounts with lock washer and nut (0.362 lbs/ft or 5 Kg/cm torque recommended)
- ▲ Operating Temperature : -25°C to +85°C
- ▲ Storage Temperature: -25°C to +100°C
- ▲ Housing Material: Chrome plated brass or Black painted brass

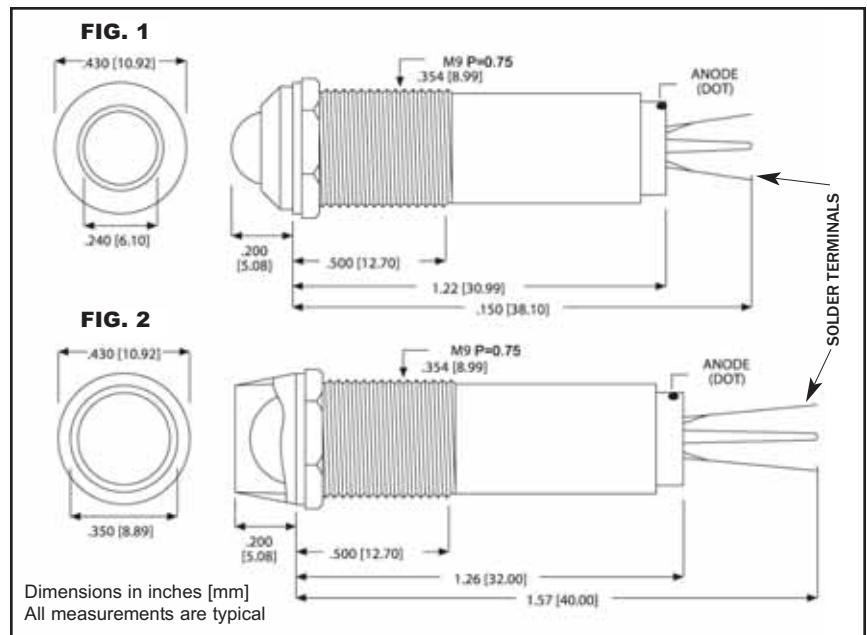

Dialight reserves the right to make changes at any time in order to supply the best product possible.

Dialight Corporation





# 609 Series LED Panel Mount Indicators for 9mm Mounting Hole

Part Number	Color	Voltage (VDC)	Current (mA)	Intensity TYP. (mcd)	LED Positions	Figure*	Finish	RoHS Compliant
609-1112-120F	Red	6	15	60	Protruding	1	C	✓
609-1122-120F	Red	6	15	60	Protruding	1	B	✓
609-1212-120F	Green	6	15	110	Protruding	1	C	✓
609-1222-120F	Green	6	15	110	Protruding	1	B	✓
609-1312-120F	Yellow	6	15	90	Protruding	1	C	✓
609-1322-120F	Yellow	6	15	90	Protruding	1	B	✓
609-1112-130F	Red	12	15	60	Protruding	1	C	✓
609-1122-130F	Red	12	15	60	Protruding	1	B	✓
609-1212-130F	Green	12	15	110	Protruding	1	C	✓
609-1222-130F	Green	12	15	110	Protruding	1	B	✓
609-1312-130F	Yellow	12	15	90	Protruding	1	C	✓
609-1322-130F	Yellow	12	15	90	Protruding	1	B	✓
609-1112-140F	Red	24	15	60	Protruding	1	C	✓
609-1122-140F	Red	24	15	60	Protruding	1	B	✓
609-1212-140F	Green	24	15	110	Protruding	1	C	✓
609-1222-140F	Green	24	15	110	Protruding	1	B	✓
609-1312-140F	Yellow	24	15	90	Protruding	1	C	✓
609-1322-140F	Yellow	24	15	90	Protruding	1	B	✓
609-2112-120F	Red	6	15	60	Recessed	2	C	✓
609-2122-120F	Red	6	15	60	Recessed	2	B	✓
609-2212-120F	Green	6	15	110	Recessed	2	C	✓
609-2222-120F	Green	6	15	110	Recessed	2	B	✓
609-2312-120F	Yellow	6	15	90	Recessed	2	C	✓
609-2322-120F	Yellow	6	15	90	Recessed	2	B	✓
609-2112-130F	Red	12	15	60	Recessed	2	C	✓
609-2122-130F	Red	12	15	60	Recessed	2	B	✓
609-2212-130F	Green	12	15	110	Recessed	2	C	✓
609-2222-130F	Green	12	15	110	Recessed	2	B	✓
609-2312-130F	Yellow	12	15	90	Recessed	2	C	✓
609-2322-130F	Yellow	12	15	90	Recessed	2	B	✓
609-2112-140F	Red	24	15	60	Recessed	2	C	✓
609-2122-140F	Red	24	15	60	Recessed	2	B	✓
609-2212-140F	Green	24	15	110	Recessed	2	C	✓
609-2222-140F	Green	24	15	110	Recessed	2	B	✓
609-2312-140F	Yellow	24	15	90	Recessed	2	C	✓
609-2322-140F	Yellow	24	15	90	Recessed	2	B	✓

Dialight reserves the right to make changes at any time in order to supply the best product possible.

\* C= Chrome, B= Black

Dialight Corporation

