

# IR-Empfänger für Fernbedienungen

## IR-Receiver for Remote Control Systems

### Lead (Pb) Free Product - RoHS Compliant

**SFH 5110**



#### **Beschreibung**

SFH 5110 ist ein Infrarot-Empfänger für die Erkennung von Signalen aus Infrarot-Fernbedienungssystemen und bestehen aus Fotodiode, Vorverstärker, automatischer Verstärkungsregelung, Bandpaß-Filter und Demodulator. Das Gehäuse ist zur Unterdrückung des Tageslichteinflusses schwarz eingefärbt.

#### **Wesentliche Merkmale**

- IC mit monolithisch integrierter Fotodiode (Ein-Chip Lösung)
- Speziell geeignet für Anwendungen von 940 nm
- Hohe Empfindlichkeit
- Verschiedene Trägerfrequenzen erhältlich
- TTL und CMOS kompatibel
- Ausgang: aktiv „Low“

#### **Anwendungen**

- Empfänger in Fernbedienungen für TV, Videorecorder, HiFi, Satellitenempfänger und CD-Spieler
- Um hohe Sicherheit bei der Datenübertragung zu erreichen, sind fehlerkorrigierende Codes einzusetzen

#### **Description**

SFH 5110 is a IR receiver to detect light from infrared remote control systems. The IC includes photodiode, preamplifier, automatic gain control, bandpass and demodulator. The black-colored package is designed as daylight-cutoff filter.

#### **Features**

- IC with monolithic integrated photodiode (single chip solution)
- Especially suitable for applications of 940 nm
- High sensitivity
- Various carrier frequencies available
- TTL and CMOS compatibility
- Output: active Low

#### **Applications**

- Remote control module for TV sets, VCRs, hi-fi audio receivers, SAT receivers and compact disk players
- For safe data transmission error tolerant codes have to be used

---

<b>Typ</b> <b>Type</b>	<b>Trägerfrequ.</b> <b>Carrier Frequency kHz</b>	<b>Bestellnr.</b> <b>Ordering Code</b>
SFH 5110-30 <sup>1)</sup>	30	Q62702P5088
SFH 5110-33 <sup>1)</sup>	33	Q62702P5089
SFH 5110-36	36	Q62702P5090
SFH 5110-38	38	Q62702P5091
SFH 5110-40 <sup>1)</sup>	40	Q62702P5092

<sup>1)</sup> Mindestbestellmenge 80000 Stück / Minimum order quantity 80000 pieces

**Grenzwerte** ( $T_A = 25\text{ °C}$ )**Maximum Ratings**

Bezeichnung Parameter	Symbol Symbol	Wert Value	Einheit Unit
Betriebs- und Lagertemperatur Operation and storage temperature range	$T_{op}$ $T_{stg}$	- 10 ... + 75 - 30 ... + 100	°C
Betriebsspannung Supply voltage	$V_{CC}$	6.3	V
Ausgangsspannung Output voltage	$V_{OUT}$	6.3	V
Ausgangsstrom Output current	$I_{OUT}$	3	mA
Verlustleistung Total power dissipation, $T_A \leq 85\text{ °C}$	$P_{tot}$	50	mW

**Empfohlener Arbeitsbereich****Recommended Operating Conditions**

Bezeichnung Parameter	Symbol Symbol	Wert Value			Einheit Unit
		min.	typ.	max.	
Betriebstemperatur Operating temperature	$T_{op}$	- 10	-	75	°C
Betriebsspannung Supply Voltage	$V_{cc}$	4.5	5.0	5.5	V

**Kennwerte** ( $T_A = 25\text{ °C}$ )**Characteristics**

Bezeichnung Parameter	Symbol Symbol	Wert Value			Einheit Unit
		min.	typ.	max.	
Stromaufnahme, $V_{CC} = 5\text{ V}$ , $E = 0$ Current consumption	$I_{CC}$	-	1.3	-	mA
Wellenlänge der max. Fotoempfindlichkeit Wavelength of max. sensitivity	$\lambda_{s\ max}$	-	940	-	nm
Spektraler Bereich der Fotoempfindlichkeit <sup>1)</sup> Spectral range of sensitivity	$\lambda$	830	-	1100	nm

**Kennwerte** ( $T_A = 25\text{ °C}$ )  
**Characteristics** (cont'd)

Bezeichnung Parameter	Symbol Symbol	Wert Value			Einheit Unit
		min.	typ.	max.	
Ausgangsspannung Output voltage Output "High" - ( $I_{out} = 10\ \mu\text{A}$ ) Output "Low" - ( $I_{out} = 500\ \mu\text{A}$ )	$V_{OUT\ high}$ $V_{OUT\ low}$	$V_{CC}-0.5$ -	- -	- 0.5	V
Trägerfrequenz Carrier frequency SFH 5110-30 SFH 5110-33 SFH 5110-36 SFH 5110-38 SFH 5110-40	$f_0$	-	30 33 36 38 40	-	kHz
Min. Bestrahlungsstärke (Testsignal, s. <b>Fig. 3</b> ) Min. Threshold irradiance (test signal, see <b>Fig. 3</b> ) $f = f_0$ , $t_{p,I} = 600\ \mu\text{s}$	$E_{e\ min}$	-	0.35	0.5	mW/m <sup>2</sup>
Min. Eingangspulsbreite „ON“ (Testsignal, s. <b>Fig. 3</b> ) <sup>2)</sup> Min. Input pulse width "ON" (test signal, see <b>Fig. 3</b> ) <sup>1)</sup>	$t_{p,I}$	$6/f_0$	-	-	$\mu\text{s}$
Ausgangspulsbreite „ON“ (Testsignal, s. <b>Fig. 3</b> ) Output pulse width "ON" (test signal, see <b>Fig. 3</b> , $E_e = 1\ \text{mW/m}^2$ )	$t_{p,O}$	$t_{p,I}$ $- 6/f_0$	-	$t_{p,I}$ $+ 6/f_0$	$\mu\text{s}$
50%-Filterbandbreite, $f = f_0$ , $E_V = 0$ , $V_{CC} = 5\ \text{V}$ 50%-Filter bandwidth	$\Delta f_{50\%}$	3	-	6	kHz

1) Außerhalb des spezifizierten Bereiches der Fotoempfindlichkeit besitzt der SFH 5110 eine Restempfindlichkeit. D.h. Lichtquellen außerhalb des spezifizierten Wellenlängenbereiches des Sensors können den Baustein beeinflussen und zum Durchschalten führen.

1) Beyond the specified spectral range of sensitivity the SFH 5110 has a strongly reduced, but non-zero sensitivity. Light sources with wavelengths outside the spectral range may influence the device and result in switching.

2) Die volle Empfindlichkeit wird bei einer Burstlänge von mindestens 6 Pulsen erreicht. Die Reichweite bei Verwendung eines typischen Senders (SFH 4510/SFH 4515,  $I_F = 500\ \text{mA}$ ) beträgt etwa 30 m.

2) A minimum burst length of 6 pulses is necessary for full sensitivity. The transmission distance with a typical transmitter (SFH 4510/SFH 4515,  $I_F = 500\ \text{mA}$ ) is about 30 m.

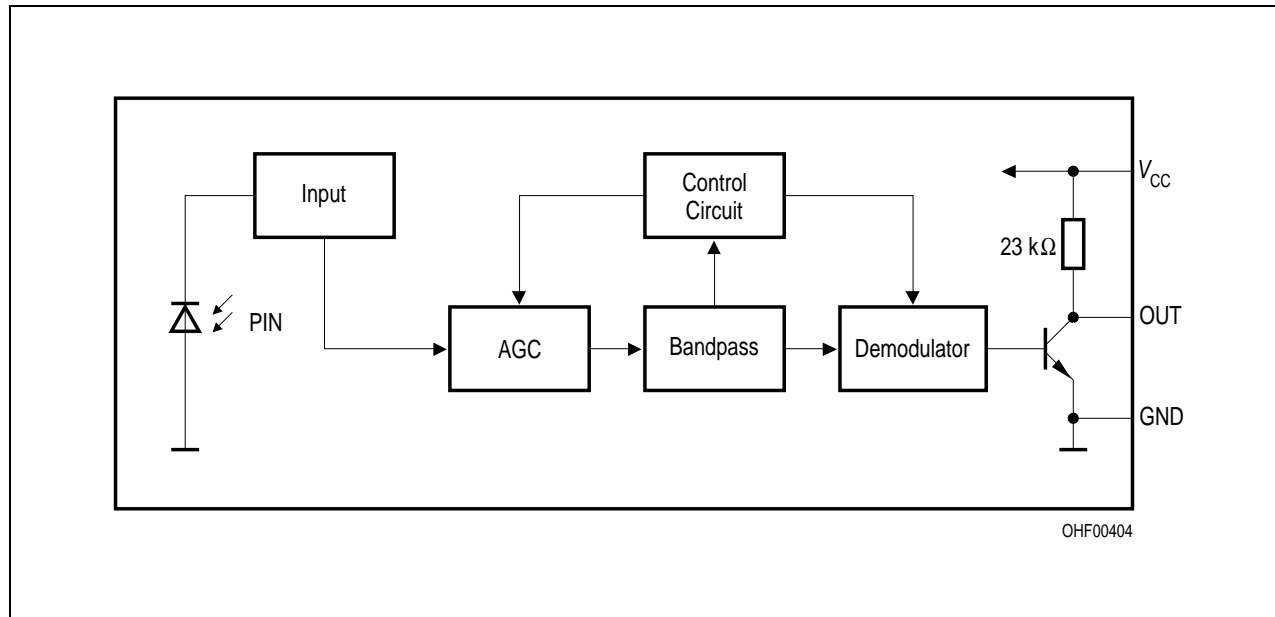

**Figure 1**      **Blockschaltbild**  
**Block Diagram**

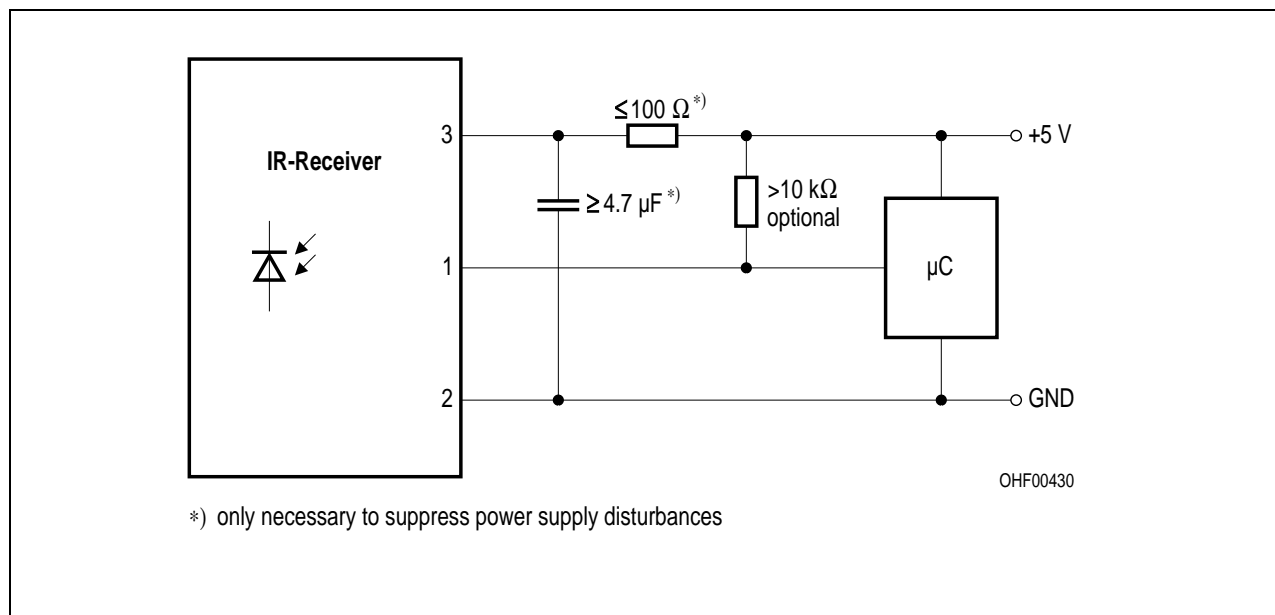

**Figure 2**      **Externe Beschaltung**  
**External Circuit**

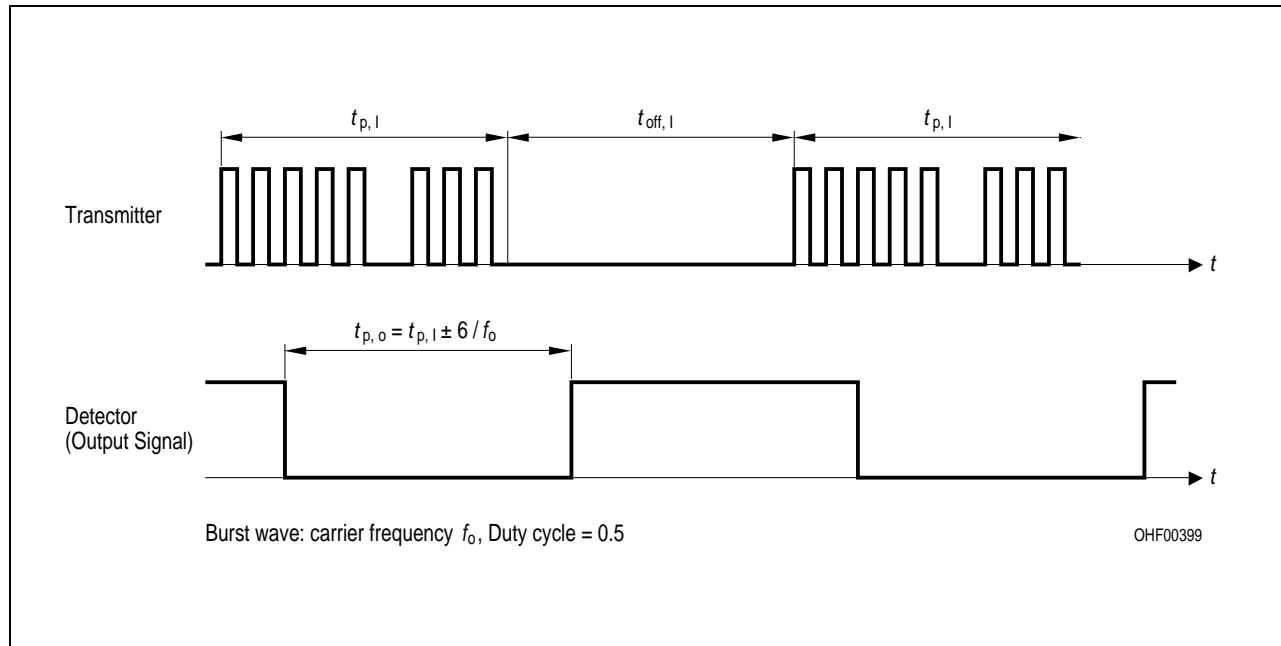

**Figure 3**      **Optisches Testsignal**  
**Optical Test Signal**

#### Anmerkungen / Notes

- Abhängig von den Umgebungsbedingungen, z.B in Form von externen Lichtquellen, elektro-magnetischer Strahlung und Rauschen der Versorgungsspannung, kann es zum sporadischen Durchschalten des Ausgang kommen, selbst wenn kein optisches Signal angelegt wird! Um Fehlinterpretationen der übermittelten Daten zu verhindern, sind fehlerkorrigierende Codes einzusetzen.

- Environmental conditions, e.g. external light sources, electromagnetic interference and supply voltage noise , may cause sporadic switching at the output, even without an optical input signal! To avoid misinterpretation of the transmitted data, error tolerant codes must be used.

Für weitere Informationen lesen Sie bitte die Application Note des SFH 5110:  
 For further information please read the application note of the SFH 5110:

[General Application Note for SFH 511X](#)

**Relative Spectral Sensitivity**

$S_{rel} = f(\lambda)$

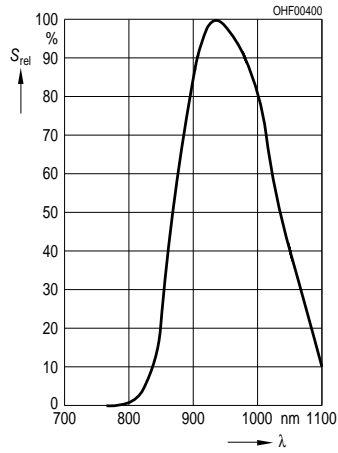

**Vertical Directivity  $\varphi_y$**

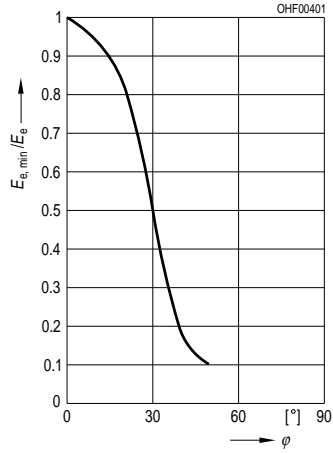

**Horizontal Directivity  $\varphi_x$**

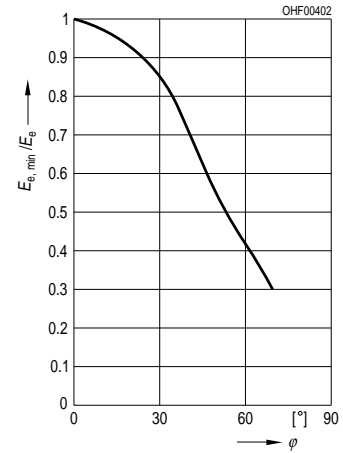

**Relative Sensitivity  $E_e/E_{e,min} = f(f_0)$**

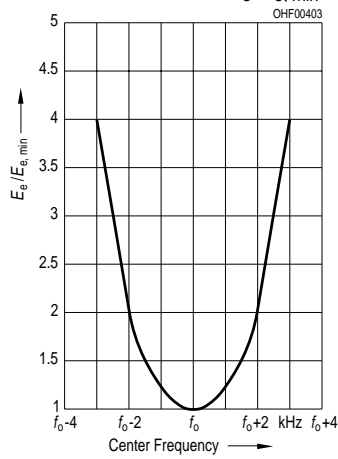





**Lötbedingungen**  
**Soldering Conditions**  
**Wellenlöten (TTW)**  
**TTW Soldering**

(nach CECC 00802)  
(acc. to CECC 00802)

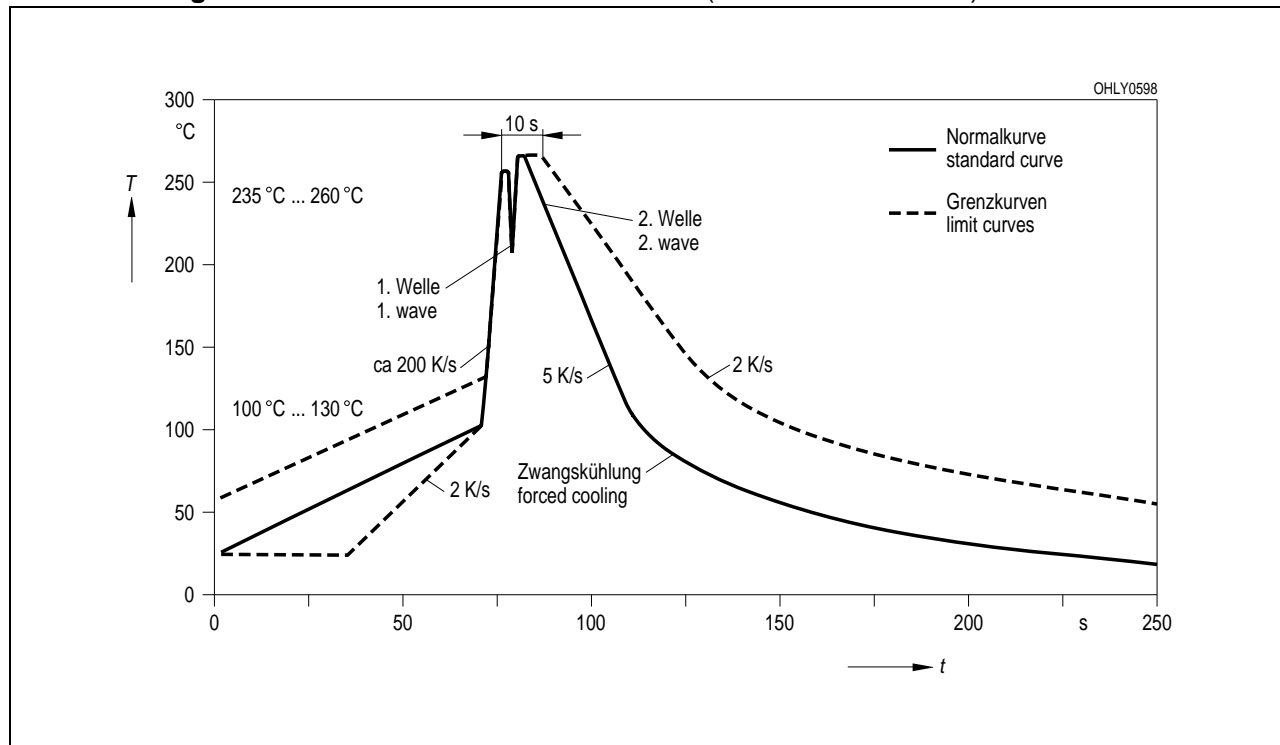

Published by  
**OSRAM Opto Semiconductors GmbH**  
Wernerwerkstrasse 2, D-93049 Regensburg  
[www.osram-os.com](http://www.osram-os.com)  
© All Rights Reserved.

EU RoHS and China RoHS compliant product



此产品符合欧盟 RoHS 指令的要求；

按照中国的相关法规和标准，不含有毒有害物质或元素。

The information describes the type of component and shall not be considered as assured characteristics. Terms of delivery and rights to change design reserved. Due to technical requirements components may contain dangerous substances. For information on the types in question please contact our Sales Organization.

**Packing**

Please use the recycling operators known to you. We can also help you – get in touch with your nearest sales office. By agreement we will take packing material back, if it is sorted. You must bear the costs of transport. For packing material that is returned to us unsorted or which we are not obliged to accept, we shall have to invoice you for any costs incurred.

**Components used in life-support devices or systems must be expressly authorized for such purpose!** Critical components <sup>1</sup>, may only be used in life-support devices or systems <sup>2</sup> with the express written approval of OSRAM OS.

<sup>1</sup> A critical component is a component used in a life-support device or system whose failure can reasonably be expected to cause the failure of that life-support device or system, or to affect its safety or effectiveness of that device or system.

<sup>2</sup> Life support devices or systems are intended (a) to be implanted in the human body, or (b) to support and/or maintain and sustain human life. If they fail, it is reasonable to assume that the health of the user may be endangered.